

MODEL: TERREMOTO V2



1/8 SCALE MONSTER TRUCK  
OWNERS MANUAL



**Fast • Affordable • Fun**

MAN-TERREMOTOV2-2016.3.08

•To ensure that you are using the most recent version of this manual:

[www.redcatracing.com/manuals/TerremotoV2.pdf](http://www.redcatracing.com/manuals/TerremotoV2.pdf)

•To ensure that you have the most recent version of the Electronic Vehicles Manual:

[www.redcatracing.com/manuals/ELECTRIC-MANUAL.pdf](http://www.redcatracing.com/manuals/ELECTRIC-MANUAL.pdf)

# WARNING!

READ ALL INSTRUCTIONS INCLUDED WITH VEHICLE BEFORE OPERATING

**AGE WARNING!**

This radio controlled (RC) vehicle is not a toy! You must be 14 years of age or older to operate this vehicle. Adult supervision is required.

**RISK OF RUNAWAY VEHICLE OR INJURY!**

Never turn on the vehicle or plug in the battery pack without first having the controller turned on.

**RISK OF FIRE! / RISK OF EXPLOSION!**

There is a risk of fire and explosion when dealing with batteries. Rechargeable batteries may become hot and catch fire if left unattended or charged too quickly. Use extra caution when charging LiPO batteries. Use only LiPO specific chargers. Use a LiPO safe charging pouch when charging LiPOs. Charge away from flammable materials. Never charge at a rate higher than 1C. {2000Mah pack= 2amps charge rate). Overcharging can lead to fire and explosion. Always store battery packs in a cool dry place.

**RISK OF BURNS!**

The batteries, electronic speed controller (ESC), electric motor, and other areas of the vehicle can get hot. Burns can occur if touched after vehicle operation. Allow adequate time to cool before handling.

**RISK OF ELECTRICAL SHOCK!**

Use caution when charging batteries. Do not touch positive and negative leads together. Do not lay battery on metal. Use only chargers specified for the battery type being charged. Keep batteries and chargers away from water.

**RISK OF INJURY!**

Hobby grade RC vehicles can cause serious injury or death if not operated correctly. Never use vehicle in crowds. Never chase people or animals. Drive in safe open areas only. Keep body parts away from moving parts.

**RISK OF DAMAGE!**

Never operate RC vehicles on public roads. Damage of vehicle and property can occur. Only operate on open private property. Never charge the battery pack while it is still plugged into the RC vehicle. Always unplug the battery pack from the electronic speed controller (ESC) and remove the battery from the RC vehicle before charging. Failure to do so will result in damage to the vehicle's electronics.

**WARNING!**

Do not mix old and new batteries. Do not mix alkaline, lithium, standard (carbon zinc), or rechargeable (nickel cadmium) batteries. Do not change or charge batteries in a hazardous location.



**FCC Compliance Statement!** The radio included with your vehicle complies with part 15 of the FCC Rules. Operation is subject to the following two conditions: (1) This device may not cause harmful interference, and (2) This device must accept any interference received, including interference that may cause undesired operations. Note: This equipment has been tested and found to comply with the limits for a Class B digital device, pursuant to Part 15 of the FCC Rules. These limits are designed to provide reasonable protection against harmful interference in a residential installation. This equipment generates, uses and can radiate radio frequency energy and, if not installed and used in accordance with the instructions, may cause harmful interference to radio communications. However, there is no guarantee that interference will not occur in a particular installation. If this equipment does cause harmful interference to radio or television reception, which can be determined by turning the equipment off and on, the user is encouraged to try to correct the interference by one of the following measures:

Reorient or relocate the receiving antenna.

Increase the separation between the equipment and receiver.

Connect the equipment into an outlet on a circuit different from that to which the receiver is connected.

Consult the dealer or an experienced radio/TV technician for help.

**WARNING:** Any changes or modifications not expressly approved by the party responsible for compliance could void the user's authority to operate this equipment.

**WARNING:** While operating the Radio, a separation distance of at least 20 centimeters must be maintained between the radiating antenna and the body of the user or nearby persons in order to meet the FCC RF exposure guidelines.

# FEATURES & SPECIFICATIONS

- Powerful 2260KV Brushless Electric Motor
- Brushless Waterproof 80A ESC (LIPO Ready)
- Forward & Reverse
- 4 Wheel Drive
- Big Bore Aluminum Oil Filled Shocks
- Dual Rechargeable 7.4v 3200mAh 20c LIPO Battery Packs \*\*
- LIPO Battery Charger \*\*
- 2.4GHz Radio System
- 15KG Waterproof Metal Gear Steering Servo

- Scale: 1/8
- Length: 550mm
- Width: 460mm
- Height: 240mm (without body)
- Wheelbase: 376mm
- Ground Clearance: 95mm (adjustable)

### Vehicle Battery Capabilities

Minimum: 11.1v total (1pc 3s/11.1v battery pack)

Maximum: 14.4v total (2pcs 2s/7.4v battery pack

**OR** 1pc 4s/14.4v battery pack)

Warning: Exceeding the maximum battery voltage may cause damage to the motor and electronic components of this vehicle and will void the vehicle warranty.

\*\*RTR VERSIONS ONLY

\*\*ARTR VERSIONS DO NOT INCLUDE BATTERIES OR CHARGER

## VEHICLE OVERVIEW

- A:** Oil Filled Shocks
- B:** Steering Servo
- C:** Steering Mechanism
- D:** On/Off Switch
- E:** ESC
- F:** 2.4GHz Receiver
- G:** Electric Motor
- H:** Steering Linkage
- I:** Upper Suspension Link
- J:** Battery Boxes
- K:** Battery Retainer Clips

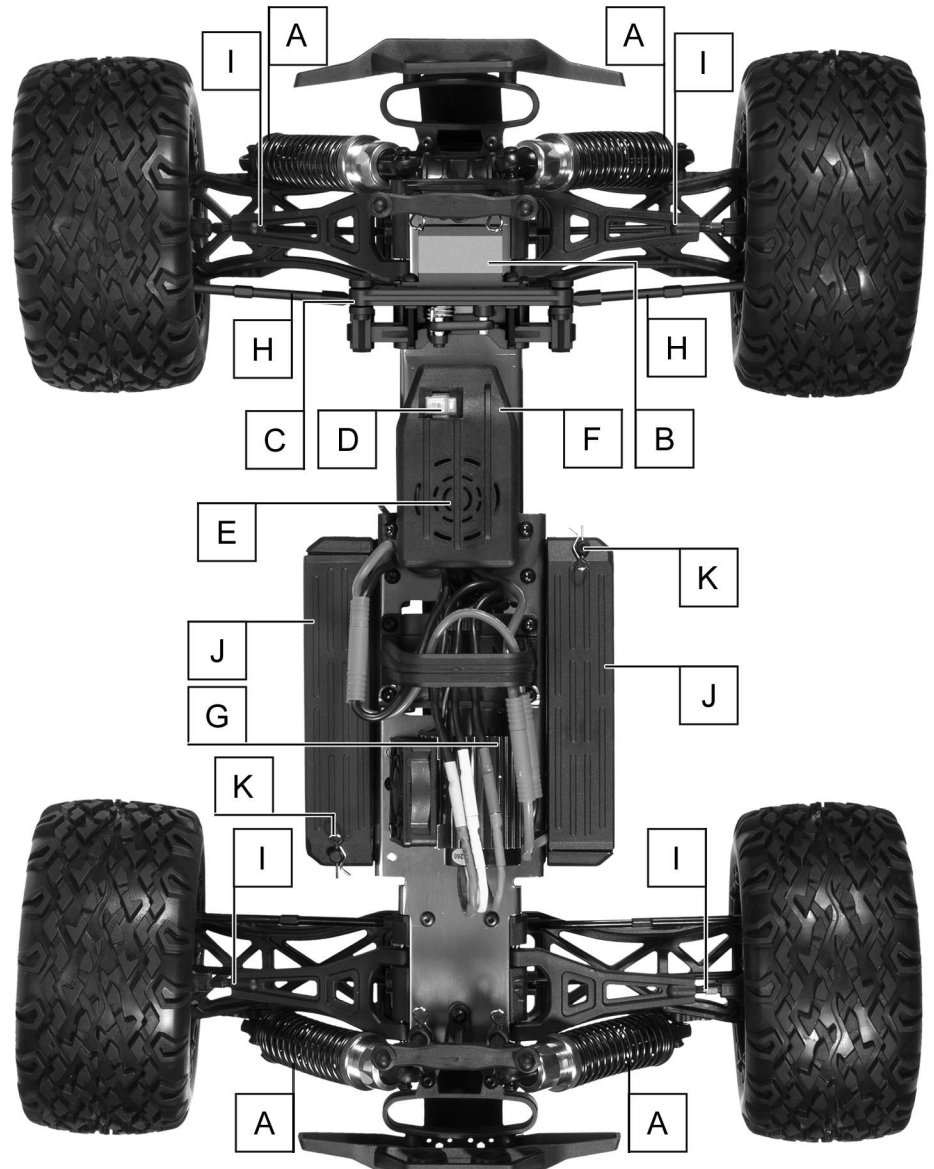

# RADIO GUIDE

**RCR-2C**  
 2.4 GHZ RADIO

CONTROL PANEL

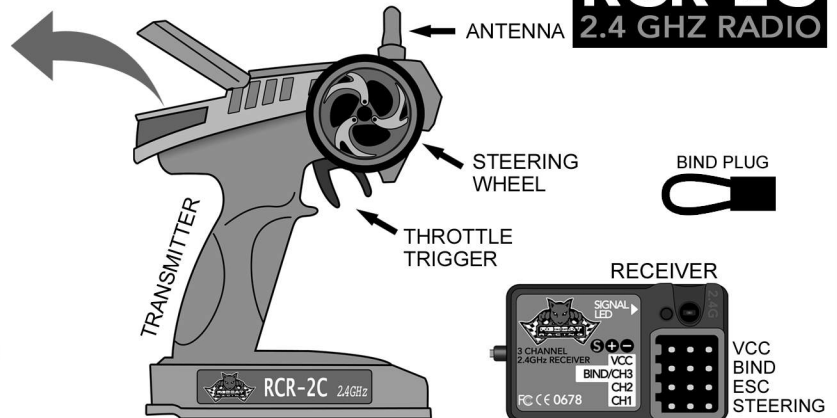

**Steering Reverse Switch:** Top left switch. Used to change steering orientation. If the car turns right when you steer left, flip this switch.

**Throttle Reverse Switch:** Top right switch. Used to change throttle trigger orientation. If the car goes in reverse while you pull the throttle trigger, flip this switch.

**Power LED:** Left LED light. Lights up when the transmitter is turned on.

**Battery Level LED:** Right LED light. Lights up green when transmitter batteries are full. Flashes when transmitter batteries are low and need replacing.

**Bind Button:** Used to bind the transmitter to the receiver. See binding instructions.

**Steering Trim:** Left knob. Used to set the steering neutral point. If the vehicle veers in one direction while the steering wheel is centered, turn this knob in the opposite direction until the car drives straight.

**Throttle Trim:** Middle knob. Used to set the throttle neutral point. If the vehicle moves forward or reverse while the throttle trigger is centered, turn this knob until the vehicle remains still. For maximum setting, turn slowly until the vehicle creeps forward, then turn the knob the opposite direction until the car stops.

**Steering Dual Rate:** Right knob. Used to limit the amount of steering. 0= little/no steering & 6= maximum steering. Set the knob to the amount of steering you feel comfortable with. If the vehicle has a tendency to spin out, lower the steering rate.

**On/Off Switch:** Bottom switch. Turns transmitter On and Off.

**VCC:** Not used.

**Bind/Ch3:** Used when binding to transmitter. Used for 3rd channel when needed.

**Ch2:** Used for Electronic Speed Controller.

**Ch1:** Used for steering servo.

### Binding:

1. Insert the BIND PLUG into the receiver BIND port.
2. Make sure your ESC is plugged into CH2, and insert the bind plug into BIND/CH3. Now, power the vehicle on and the receiver light should begin to blink red.
3. Press the BIND button in the center of the transmitter's Control Panel and turn on radio.
4. Release the bind button when you see the green light on the radio flashing. At this point, your receiver's LED should now be solid red. Turn off the power to your vehicle, as well as the radio.
5. Remove the BIND PLUG from the receiver. Make sure the servos and ESC are attached as described above.
6. First turn your radio on, then your vehicle as normal. Your radio and receiver should be bound together and communicating with each other.

# LIPO CHARGER

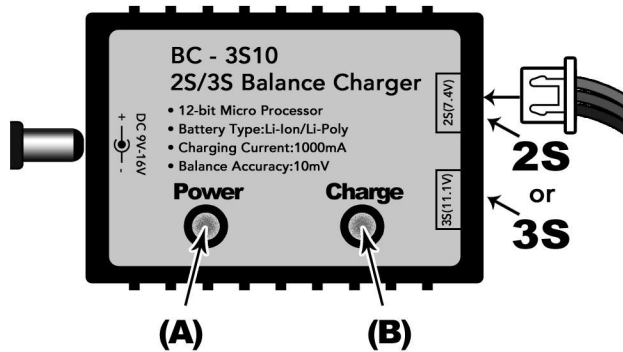

**LIPO:** The BC - 3S10 Balance charger is capable of charging 2S and 3S LIPO batteries.

**DC Port:** Single round port on left end of charger. Plug in DC adapter here.

**Power LED:** Left LED light. Lights up when charger is connected to a 110v power source.

**Charge LED:** Right LED light. Blinks while battery is charging. LED light will turn solid red when battery is fully charged

**2S Port:** Used to charge 2S 7.4v LIPO battery packs.

**3S Port:** Used to charge 3S 11.1v LIPO battery packs.

### Charging Instructions:

1. Unplug the battery pack from the ESC and remove the battery from the vehicle.
2. Plug the charger into a 110v power receptacle using the included DC power adapter. Power light will be on.
3. Plug the 2S/3S LIPO battery "balance charge plug" into the appropriate charge port. (as seen above) - Charge light will blink while the LIPO battery is charging.
4. When the charge light turns solid red, unplug the battery as charging is complete.
5. Unplug charger from the 110v power source.

### - ATTENTION -

Battery and charger are only included with the RTR version! If you purchased item number: TERREMOTO-BLUE-NOBATTERIES-NOCHARGER you will not have a battery or charger in your box. Please read all instructions that came with the battery and charger you plan to use.

### - ATTENTION -

When plugging the battery pack into the ESC, make sure the plugs are lined up correctly!

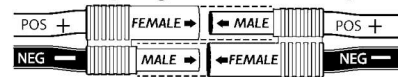

Ensure POS+ wire is connected to POS+ & NEG- is connected to NEG-

STOP

**WARNING**

STOP

### UNPLUG THE BATTERY PACK FROM THE VEHICLE!

BEFORE CHARGING YOUR BATTERY PACK, YOU MUST FIRST UNPLUG IT FROM THE ESC. FAILURE TO UNPLUG THE BATTERY FROM THE VEHICLE'S ESC BEFORE CHARGING MAY PERMANENTLY DAMAGE SOME OR ALL ELECTRONICS IN THE VEHICLE.

**NEVER LEAVE BATTERY PACKS UNATTENDED WHILE CHARGING!** Leaving a battery unattended while charging may result in fire and damage / injury.

**NEVER ALLOW A BATTERY PACK TO GET HOT!** It's normal for the battery pack to get warm, but it should never get hot! Monitor batteries during charging and unplug to let cool if the battery gets hot.

**WHEN CHARGING LIPOs, A LIPO SAFE CHARGING BAG SHOULD BE USED TO HELP PREVENT FIRES.**





# PARTS IDENTIFICATION

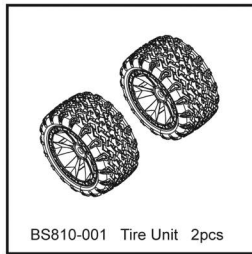

BS810-001 Tire Unit 2pcs

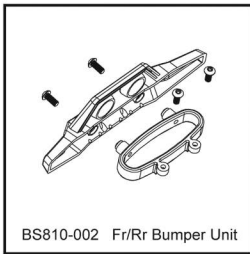

BS810-002 Fr/Rr Bumper Unit

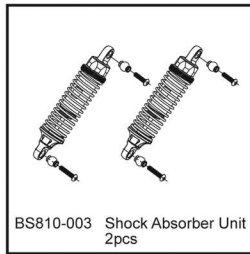

BS810-003 Shock Absorber Unit 2pcs

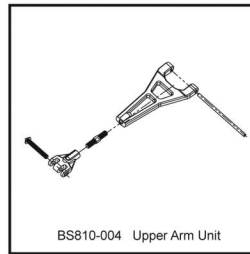

BS810-004 Upper Arm Unit

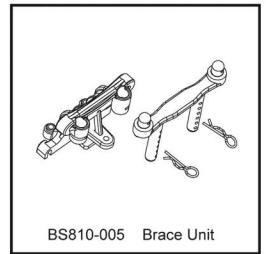

BS810-005 Brace Unit

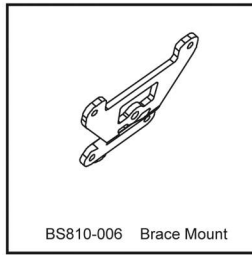

BS810-006 Brace Mount

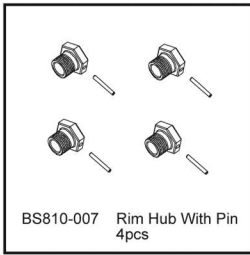

BS810-007 Rim Hub With Pin 4pcs

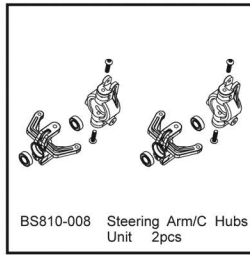

BS810-008 Steering Arm/C Hubs Unit 2pcs

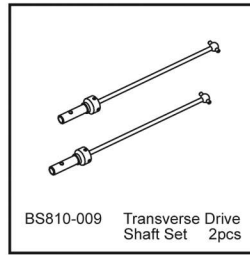

BS810-009 Transverse Drive Shaft Set 2pcs

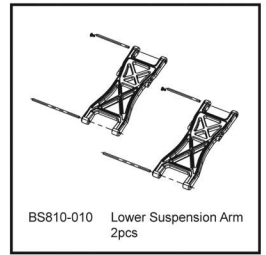

BS810-010 Lower Suspension Arm 2pcs

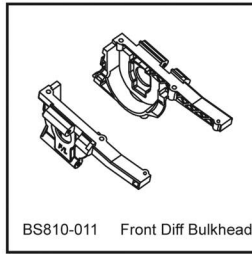

BS810-011 Front Diff Bulkhead

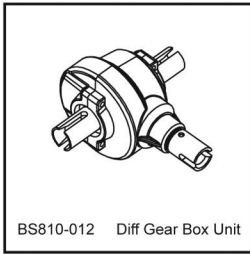

BS810-012 Diff Gear Box Unit

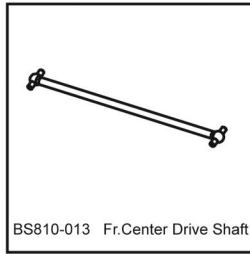

BS810-013 Fr.Center Drive Shaft

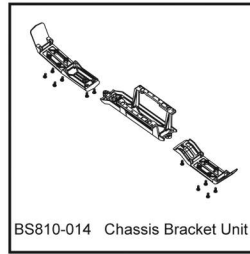

BS810-014 Chassis Bracket Unit

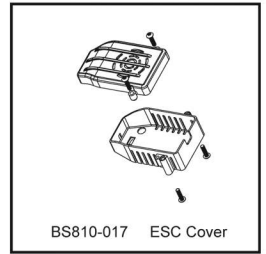

BS810-017 ESC Cover

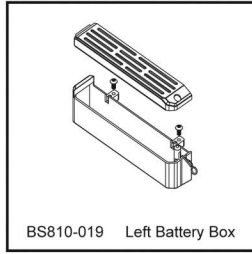

BS810-019 Left Battery Box

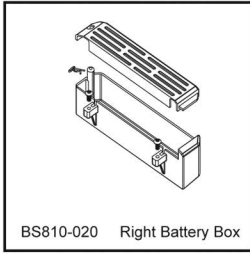

BS810-020 Right Battery Box

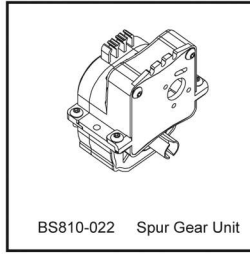

BS810-022 Spur Gear Unit

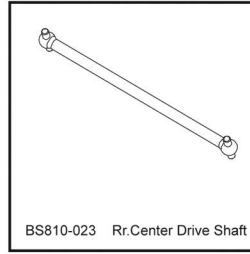

BS810-023 Rr.Center Drive Shaft

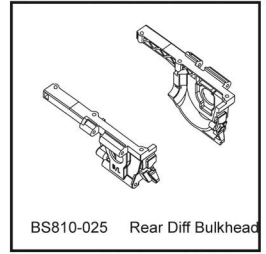

BS810-025 Rear Diff Bulkhead

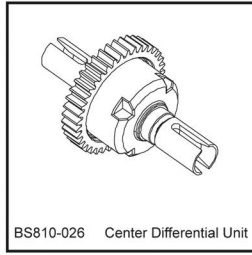

BS810-026 Center Differential Unit

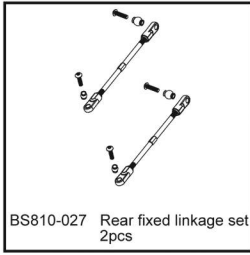

BS810-027 Rear fixed linkage set 2pcs

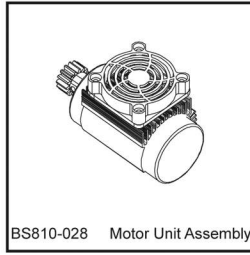

BS810-028 Motor Unit Assembly

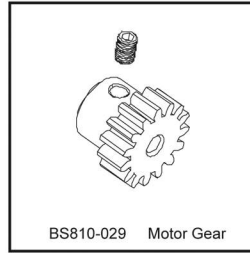

BS810-029 Motor Gear

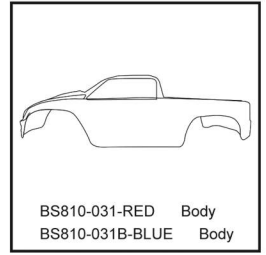

BS810-031-RED Body  
BS810-031B-BLUE Body

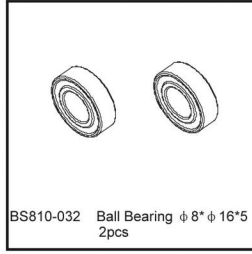

BS810-032 Ball Bearing  $\phi 8 \times \phi 16 \times 5$  2pcs

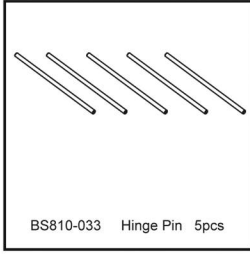

BS810-033 Hinge Pin 5pcs

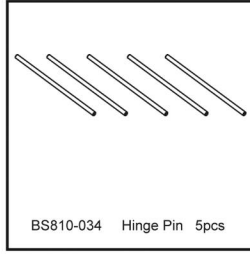

BS810-034 Hinge Pin 5pcs

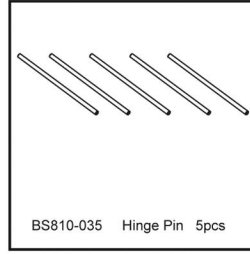

BS810-035 Hinge Pin 5pcs

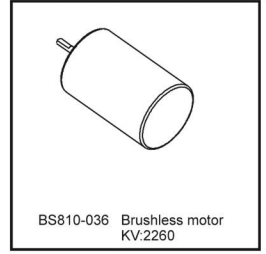

BS810-036 Brushless motor KV:2260

# PARTS IDENTIFICATION

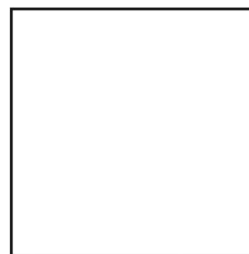
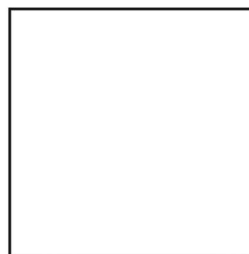
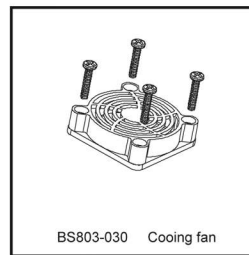
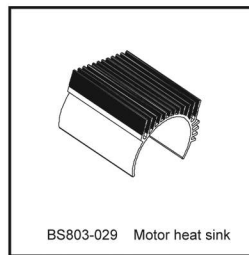
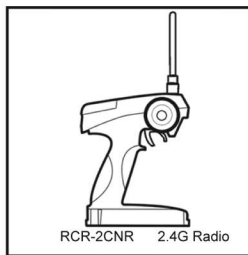
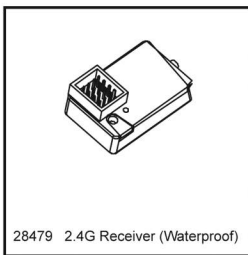
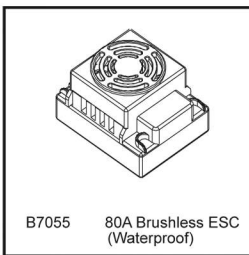
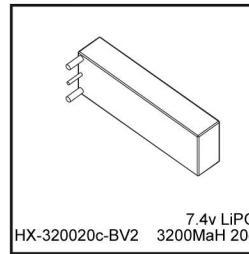
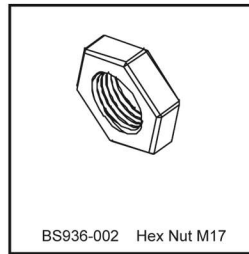
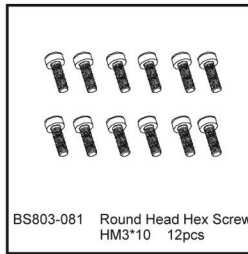
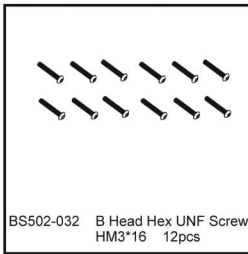
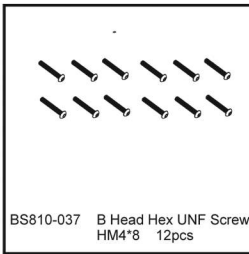
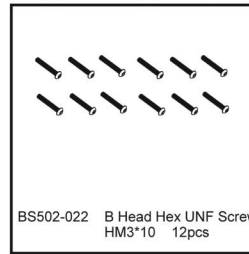
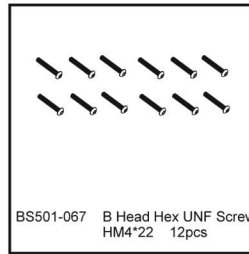
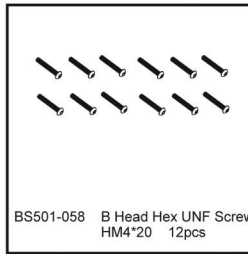
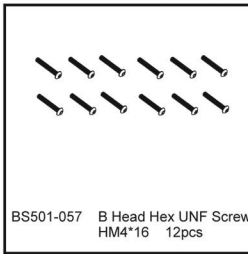
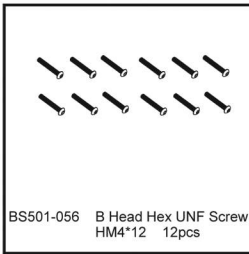
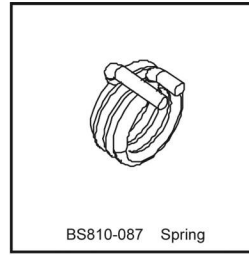
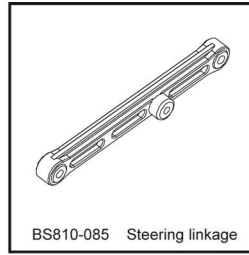
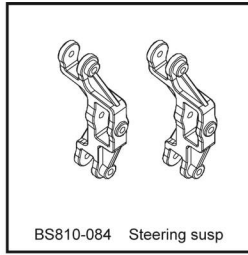
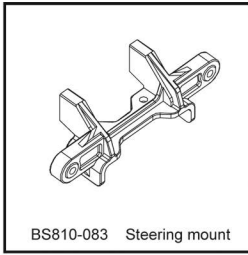
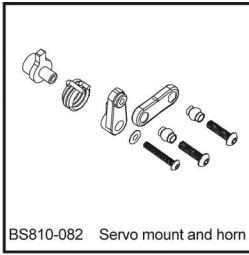
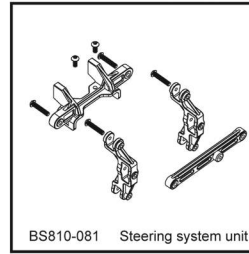
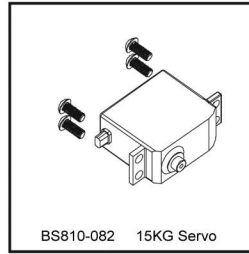
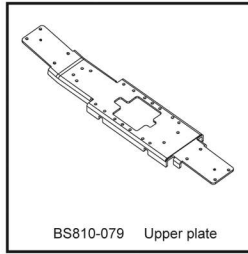
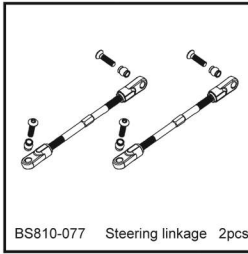
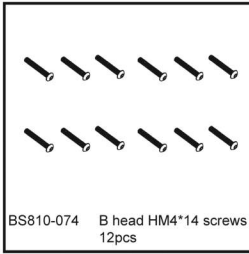





**FAST  AFFORDABLE  FUN**

[www.redcatracing.com](http://www.redcatracing.com)

MAN-TERREMOTOV2-2016.3.08

•To ensure that you are using the most recent version of this manual:  
[www.redcatracing.com/manuals/TerremotoV2.pdf](http://www.redcatracing.com/manuals/TerremotoV2.pdf)

•To ensure that you have the most recent version of the Electronic Vehicles Manual:  
[www.redcatracing.com/manuals/ELECTRIC-MANUAL.pdf](http://www.redcatracing.com/manuals/ELECTRIC-MANUAL.pdf)