

MODEL: TERREMOTO-10-V2



TERREMOTO 10^{v2}

1/10 SCALE MONSTER TRUCK
OWNERS MANUAL



Fast • Affordable • Fun

MAN-TERREMOTO10V2-2016.4.13

•To ensure that you are using the most recent version of this manual:

www.redcatracing.com/manuals/TERREMOTO10MANUAL.pdf

•To ensure that you have the most recent version of the Electronic Vehicles Manual:

www.redcatracing.com/manuals/ELECTRIC-MANUAL.pdf

WARNING!

READ ALL INSTRUCTIONS INCLUDED WITH VEHICLE BEFORE OPERATING

**AGE WARNING!**

This radio controlled (RC) vehicle is not a toy! You must be 14 years of age or older to operate this vehicle. Adult supervision is required.

**RISK OF RUNAWAY VEHICLE OR INJURY!**

Never turn on the vehicle or plug in the battery pack without first having the controller turned on.

**RISK OF FIRE! / RISK OF EXPLOSION!**

There is a risk of fire and explosion when dealing with batteries. Rechargeable batteries may become hot and catch fire if left unattended or charged too quickly. Use extra caution when charging LiPO batteries. Use only LiPO specific chargers. Use a LiPO safe charging pouch when charging LiPOs. Charge away from flammable materials. Never charge at a rate higher than 1C. {2000Mah pack= 2amps charge rate). Overcharging can lead to fire and explosion. Always store battery packs in a cool dry place.

**RISK OF BURNS!**

The batteries, electronic speed controller (ESC), electric motor, and other areas of the vehicle can get hot. Burns can occur if touched after vehicle operation. Allow adequate time to cool before handling.

**RISK OF ELECTRICAL SHOCK!**

Use caution when charging batteries. Do not touch positive and negative leads together. Do not lay battery on metal. Use only chargers specified for the battery type being charged. Keep batteries and chargers away from water.

**RISK OF INJURY!**

Hobby grade RC vehicles can cause serious injury or death if not operated correctly. Never use vehicle in crowds. Never chase people or animals. Drive in safe open areas only. Keep body parts away from moving parts.

**RISK OF DAMAGE!**

Never operate RC vehicles on public roads. Damage of vehicle and property can occur. Only operate on open private property. Never charge the battery pack while it is still plugged into the RC vehicle. Always unplug the battery pack from the electronic speed controller (ESC) and remove the battery from the RC vehicle before charging. Failure to do so will result in damage to the vehicle's electronics.

**WARNING!**

Do not mix old and new batteries. Do not mix alkaline, lithium, standard (carbon zinc), or rechargeable (nickel cadmium) batteries. Do not change or charge batteries in a hazardous location.



FCC Compliance Statement! The radio included with your vehicle complies with part 15 of the FCC Rules. Operation is subject to the following two conditions: (1) This device may not cause harmful interference, and (2) This device must accept any interference received, including interference that may cause undesired operations. Note: This equipment has been tested and found to comply with the limits for a Class B digital device, pursuant to Part 15 of the FCC Rules. These limits are designed to provide reasonable protection against harmful interference in a residential installation. This equipment generates, uses and can radiate radio frequency energy and, if not installed and used in accordance with the instructions, may cause harmful interference to radio communications. However, there is no guarantee that interference will not occur in a particular installation. If this equipment does cause harmful interference to radio or television reception, which can be determined by turning the equipment off and on, the user is encouraged to try to correct the interference by one of the following measures:

Reorient or relocate the receiving antenna.

Increase the separation between the equipment and receiver.

Connect the equipment into an outlet on a circuit different from that to which the receiver is connected.

Consult the dealer or an experienced radio/TV technician for help.

WARNING: Any changes or modifications not expressly approved by the party responsible for compliance could void the user's authority to operate this equipment.

WARNING: While operating the Radio, a separation distance of at least 20 centimeters must be maintained between the radiating antenna and the body of the user or nearby persons in order to meet the FCC RF exposure guidelines.

FEATURES & SPECIFICATIONS

- Powerful Brushless 3000KV Electric Motor
- Brushless Waterproof 80A ESC (2s-3s LIPO Ready)
- Forward & Reverse
- 4 Wheel Drive
- Aluminum Oil Filled Long Travel Shocks
- 7.4v 3200mAh 20c LIPO Battery Pack
- LIPO Battery Charger
- 2.4GHz Radio System
- 15KG Metal Gear Waterproof Steering Servo

- Scale: 1/10
- Length: 500mm
- Width: 360mm
- Height: 210mm
- Wheelbase: 316mm
- Ground Clearance: 55mm

Vehicle Battery Capabilities

Minimum: 7.4v total (1pc 2s/7.4v battery pack)

Maximum: 11.1v total (1pc 3s/11.1v battery pack)

Warning: Exceeding the maximum battery voltage may cause damage to the motor and electronic components of this vehicle and will void the vehicle warranty.

VEHICLE OVERVIEW

- A: Oil Filled Shocks
- B: Steering Servo
- C: Steering Mechanism
- D: On/Off Switch
- E: ESC
- F: 2.4GHz Receiver
- G: Electric Motor
- H: Steering Linkage
- I: Upper Suspension Link
- J: Battery
- K: Battery Retainer

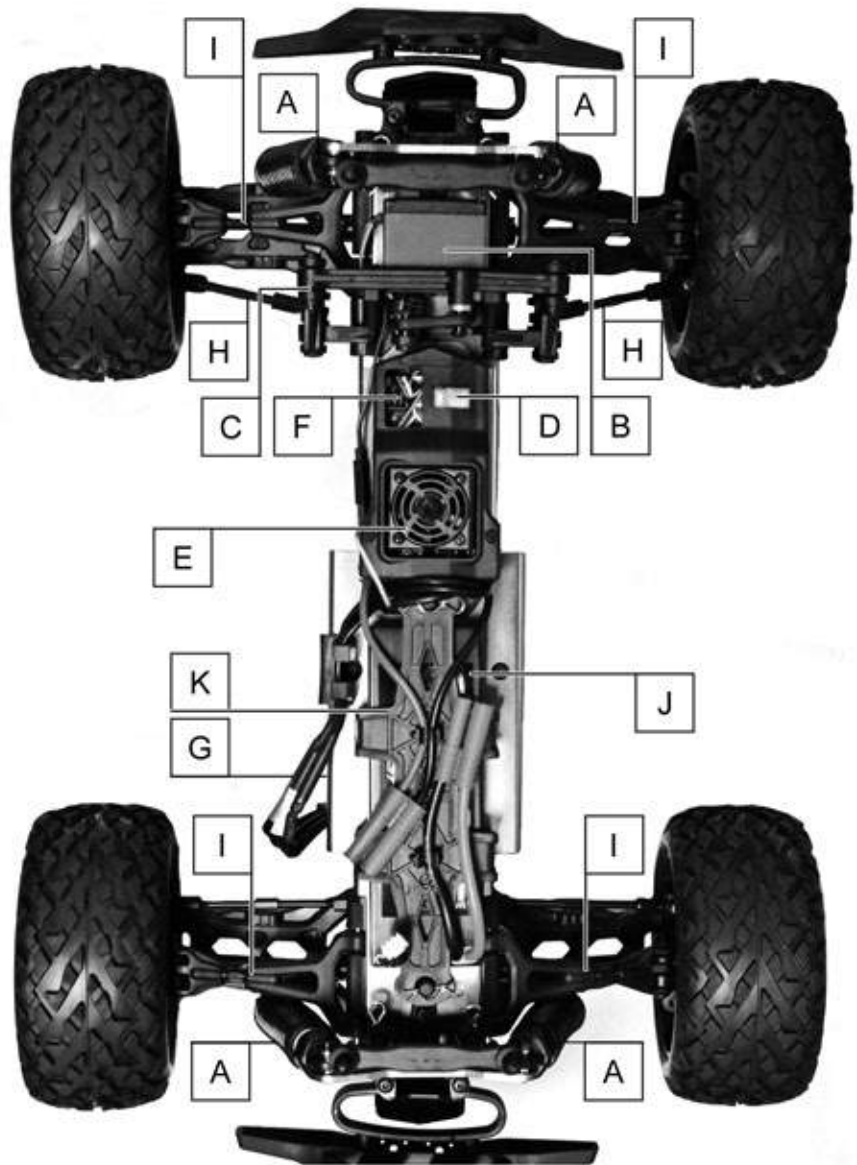

RADIO GUIDE

CONTROL PANEL

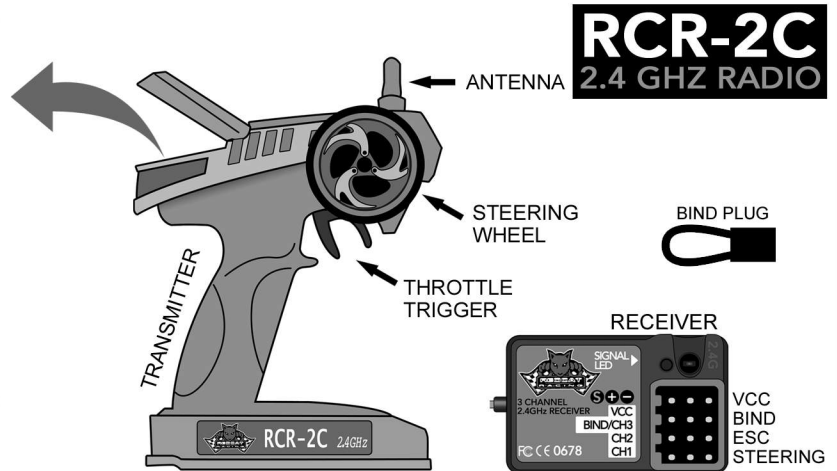

Steering Reverse Switch: Top left switch. Used to change steering orientation. If the car turns right when you steer left, flip this switch.

Throttle Reverse Switch: Top right switch. Used to change throttle trigger orientation. If the car goes in reverse while you pull the throttle trigger, flip this switch.

Power LED: Left LED light. Lights up when the transmitter is turned on.

Battery Level LED: Right LED light. Lights up green when transmitter batteries are full. Flashes when transmitter batteries are low and need replacing.

Bind Button: Used to bind the transmitter to the receiver. See binding instructions.

Steering Trim: Left knob. Used to set the steering neutral point. If the vehicle veers in one direction while the steering wheel is centered, turn this knob in the opposite direction until the car drives straight.

Throttle Trim: Middle knob. Used to set the throttle neutral point. If the vehicle moves forward or reverse while the throttle trigger is centered, turn this knob until the vehicle remains still. For maximum setting, turn slowly until the vehicle creeps forward, then turn the knob the opposite direction until the car stops.

Steering Dual Rate: Right knob. Used to limit the amount of steering. 0= little/no steering & 6= maximum steering. Set the knob to the amount of steering you feel comfortable with. If the vehicle has a tendency to spin out, lower the steering rate.

On/Off Switch: Bottom switch. Turns transmitter On and Off.

VCC: Not used.

Bind/Ch3: Used when binding to transmitter. Used for 3rd channel when needed.

Ch2: Used for Electronic Speed Controller.

Ch1: Used for steering servo.

Binding:

1. Insert the BIND PLUG into the receiver BIND port.
2. Make sure your ESC is plugged into CH2, and insert the bind plug into BIND/CH3. Now, power the vehicle on and the receiver light should begin to blink red.
3. Press the BIND button in the center of the transmitter's Control Panel and turn on radio.
4. Release the bind button when you see the green light on the radio flashing. At this point, your receiver's LED should now be solid red. Turn off the power to your vehicle, as well as the radio.
5. Remove the BIND PLUG from the receiver. Make sure the servos and ESC are attached as described above.
6. First turn your radio on, then your vehicle as normal. Your radio and receiver should be bound together and communicating with each other.

LIPO CHARGER

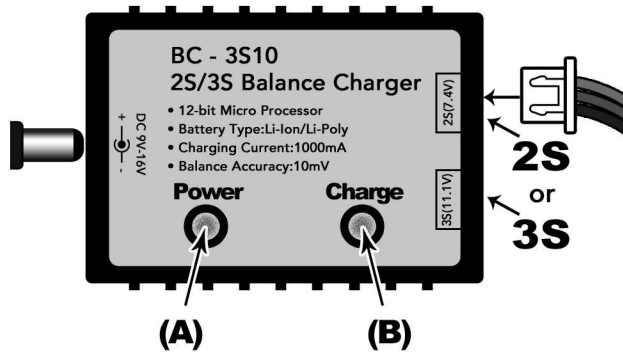

LIPO: The BC - 3S10 Balance charger is capable of charging 2S and 3S LIPO batteries.

DC Port: Single round port on left end of charger. Plug in DC adapter here.

Power LED: Left LED light. Lights up when charger is connected to a 110v power source.

Charge LED: Right LED light. Blinks while battery is charging.
LED light will turn solid red when battery is fully charged

2S Port: Used to charge 2S 7.4v LIPO battery packs.

3S Port: Used to charge 3S 11.1v LIPO battery packs.

Charging Instructions:

1. Unplug the battery pack from the ESC and remove the battery from the vehicle.
2. Plug the charger into a 110v power receptacle using the included DC power adapter. Power light will be on.
3. Plug the 2S/3S LIPO battery "balance charge plug" into the appropriate charge port. (as seen above) - Charge light will blink while the LIPO battery is charging.
4. When the charge light turns solid red, unplug the battery as charging is complete.
5. Unplug charger from the 110v power source.

- ATTENTION -

When plugging the battery pack into the ESC, make sure the plugs are lined up correctly!

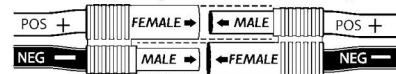

Ensure POS+ wire is connected to POS+ & NEG- is connected to NEG-



UNPLUG THE BATTERY PACK FROM THE VEHICLE!

BEFORE CHARGING YOUR BATTERY PACK, YOU MUST FIRST UNPLUG IT FROM THE ESC. FAILURE TO UNPLUG THE BATTERY FROM THE VEHICLE'S ESC BEFORE CHARGING MAY PERMANENTLY DAMAGE SOME OR ALL ELECTRONICS IN THE VEHICLE.

NEVER LEAVE BATTERY PACKS UNATTENDED WHILE CHARGING! Leaving a battery unattended while charging may result in fire and damage / injury.

NEVER ALLOW A BATTERY PACK TO GET HOT! It's normal for the battery pack to get warm, but it should never get hot! Monitor batteries during charging and unplug to let cool if the battery gets hot.

WHEN CHARGING LIPOs, A LIPO SAFE CHARGING BAG SHOULD BE USED TO HELP PREVENT FIRES.

Exploded View - Terremoto 10

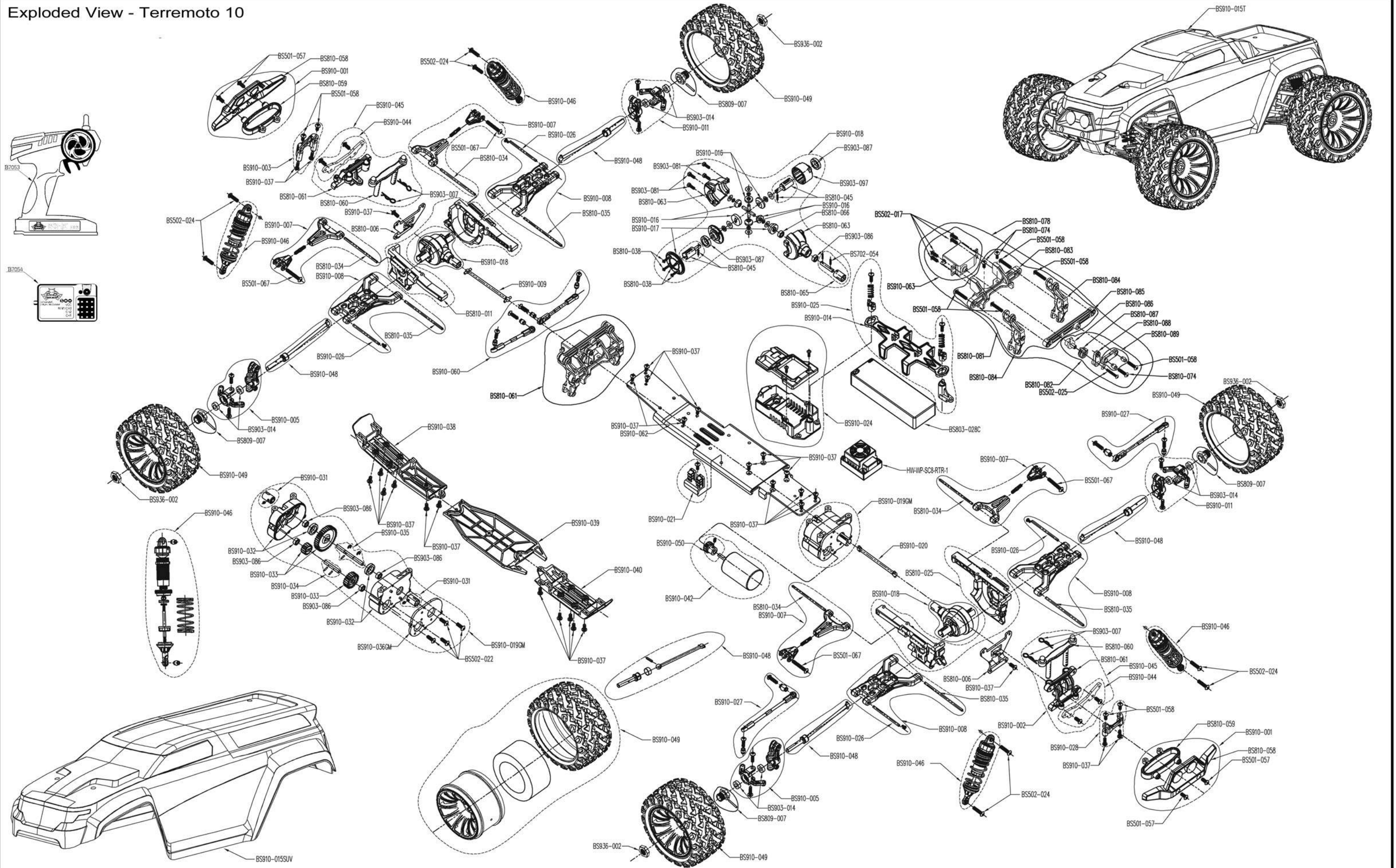

PARTS IDENTIFICATION

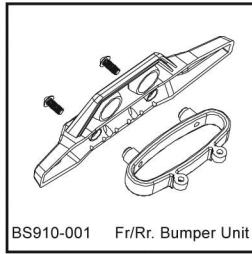

BS910-001 Fr/Rr. Bumper Unit

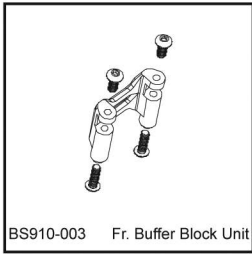

BS910-003 Fr. Buffer Block Unit

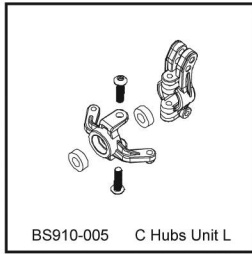

BS910-005 C Hubs Unit L

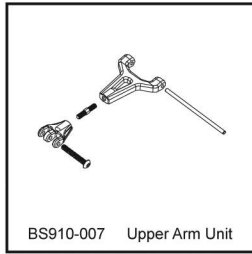

BS910-007 Upper Arm Unit

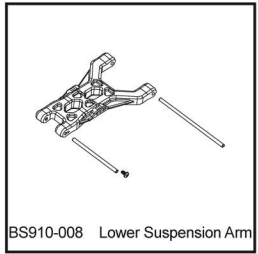

BS910-008 Lower Suspension Arm

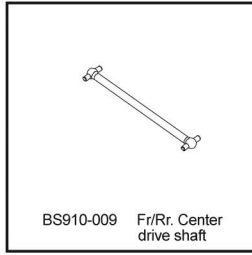

BS910-009 Fr/Rr. Center drive shaft

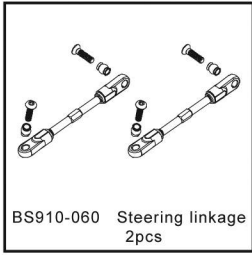

BS910-060 Steering linkage 2pcs

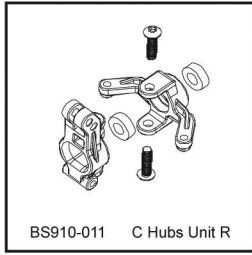

BS910-011 C Hubs Unit R

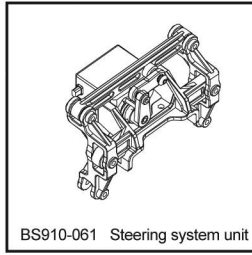

BS910-061 Steering system unit

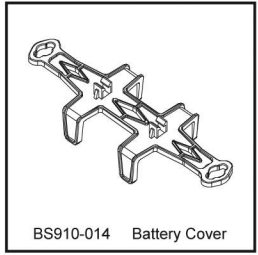

BS910-014 Battery Cover

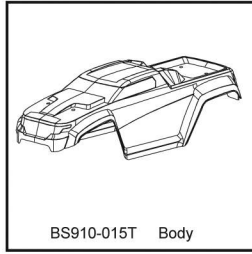

BS910-015T Body

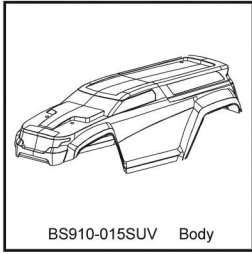

BS910-015SUV Body

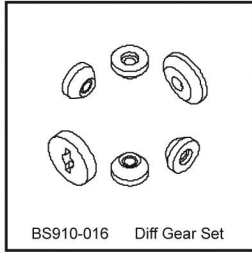

BS910-016 Diff Gear Set

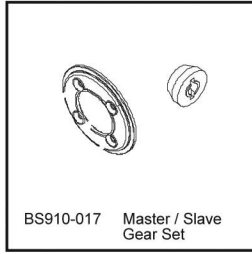

BS910-017 Master / Slave Gear Set

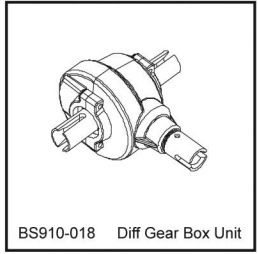

BS910-018 Diff Gear Box Unit

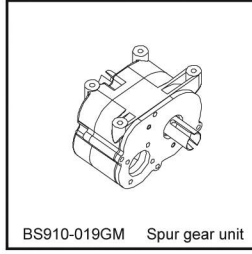

BS910-019GM Spur gear unit

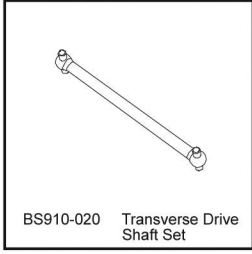

BS910-020 Transverse Drive Shaft Set

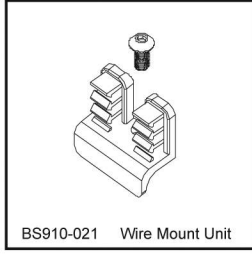

BS910-021 Wire Mount Unit

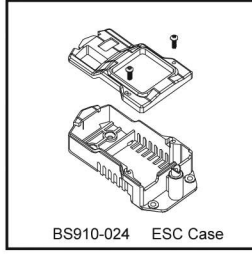

BS910-024 ESC Case

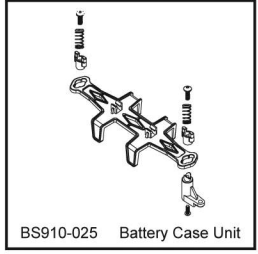

BS910-025 Battery Case Unit

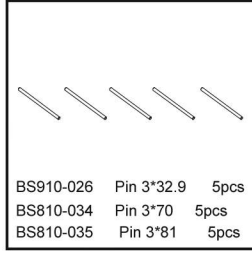

BS910-026 Pin 3*32.9 5pcs
BS810-034 Pin 3*70 5pcs
BS810-035 Pin 3*81 5pcs



BS910-027 Rr. Steering linkage set 2pcs

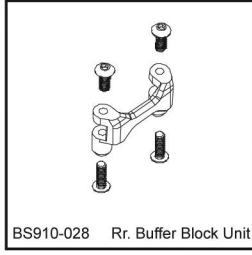

BS910-028 Rr. Buffer Block Unit

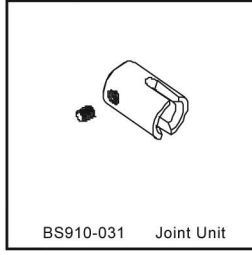

BS910-031 Joint Unit

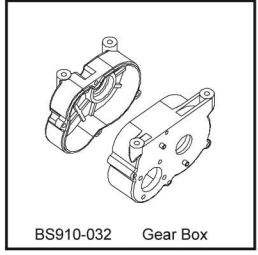

BS910-032 Gear Box

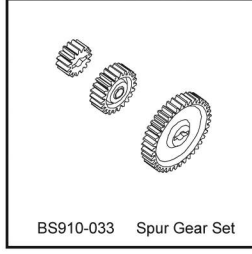

BS910-033 Spur Gear Set

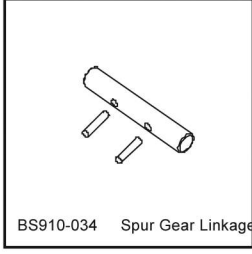

BS910-034 Spur Gear Linkage

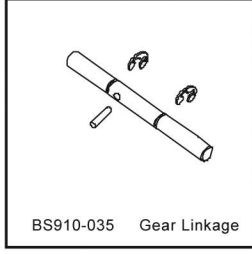

BS910-035 Gear Linkage

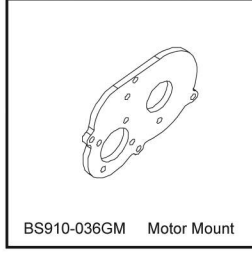

BS910-036GM Motor Mount

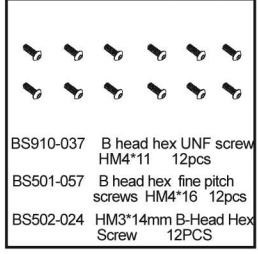

BS910-037 B head hex UNF screw HM4*11 12pcs
BS501-057 B head hex fine pitch screws HM4*16 12pcs
BS502-024 HM3*14mm B-Head Hex Screw 12PCS

PARTS IDENTIFICATION

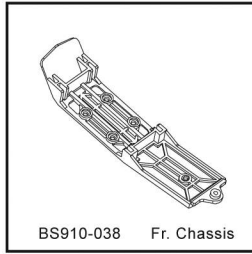

BS910-038 Fr. Chassis

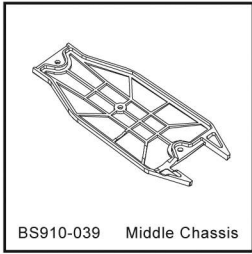

BS910-039 Middle Chassis

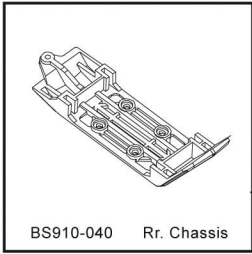

BS910-040 Rr. Chassis

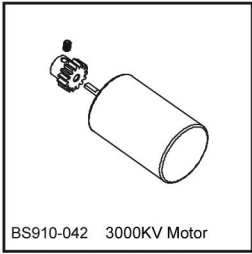

BS910-042 3000KV Motor

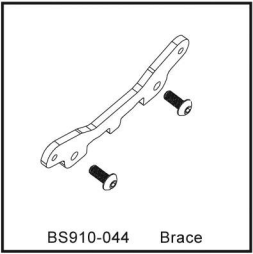

BS910-044 Brace

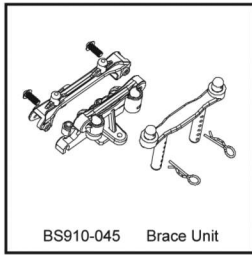

BS910-045 Brace Unit



BS910-046 Shock Absorber Unit
2pcs

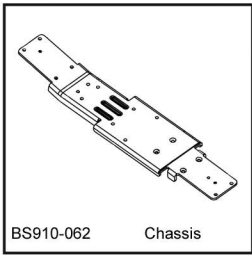

BS910-062 Chassis

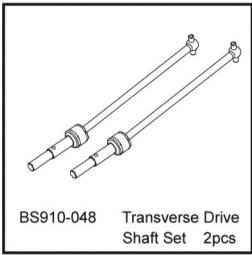

BS910-048 Transverse Drive
Shaft Set 2pcs

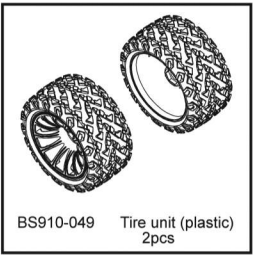

BS910-049 Tire unit (plastic)
2pcs

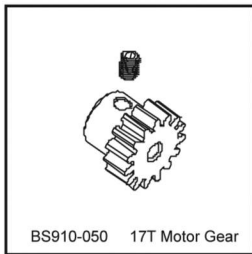

BS910-050 17T Motor Gear

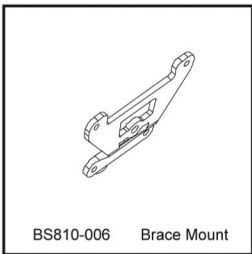

BS810-006 Brace Mount

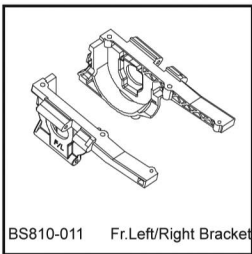

BS810-011 Fr.Left/Right Bracket

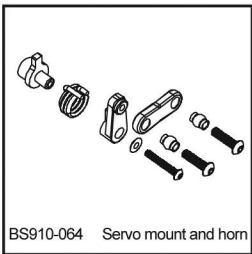

BS910-064 Servo mount and horn

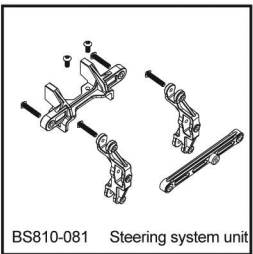

BS810-081 Steering system unit

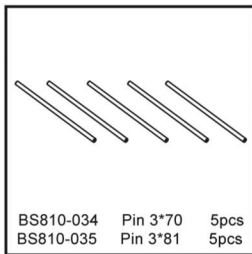

BS810-034 Pin 3*70 5pcs
BS810-035 Pin 3*81 5pcs

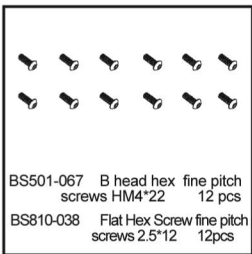

BS501-067 B head hex fine pitch
screws HM4*22 12 pcs
BS810-038 Flat Hex Screw fine pitch
screws 2.5*12 12pcs

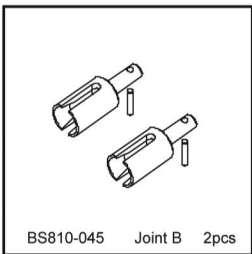

BS810-045 Joint B 2pcs

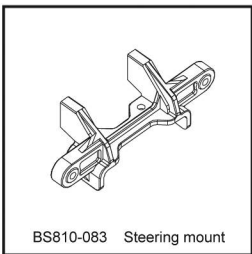

BS810-083 Steering mount

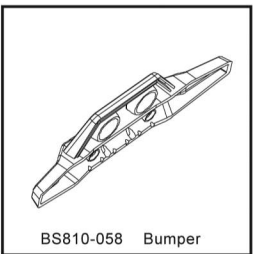

BS810-058 Bumper

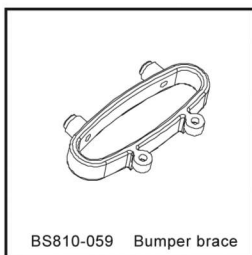

BS810-059 Bumper brace

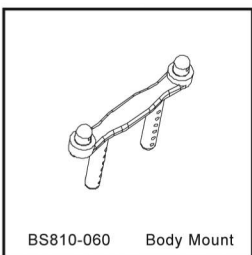

BS810-060 Body Mount

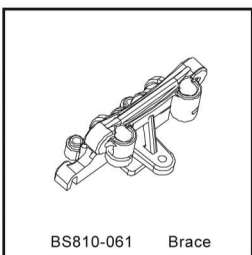

BS810-061 Brace

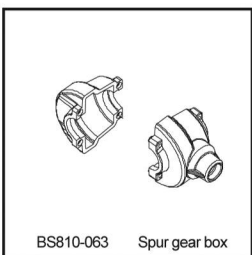

BS810-063 Spur gear box

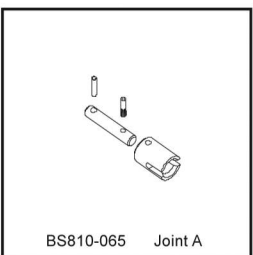

BS810-065 Joint A

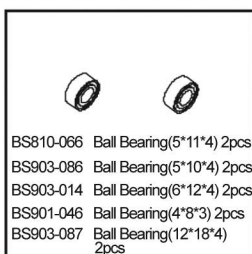

BS810-066 Ball Bearing(5*11*4) 2pcs
BS903-086 Ball Bearing(5*10*4) 2pcs
BS903-014 Ball Bearing(6*12*4) 2pcs
BS901-046 Ball Bearing(4*8*3) 2pcs
BS903-087 Ball Bearing(12*18*4)
2pcs

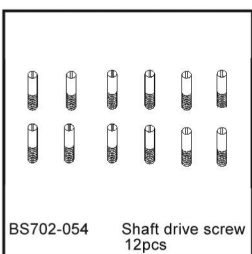

BS702-054 Shaft drive screw
12pcs

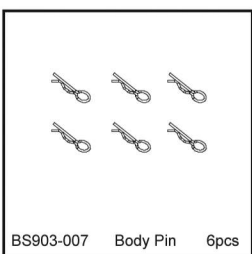

BS903-007 Body Pin 6pcs

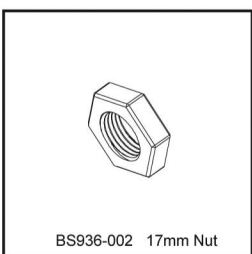

BS936-002 17mm Nut

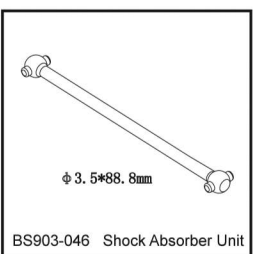

BS903-046 Shock Absorber Unit
 $\phi 3.5 \times 68.8 \text{mm}$

PARTS IDENTIFICATION

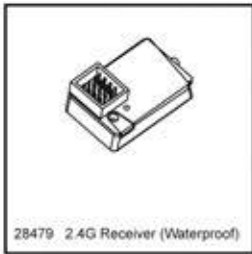
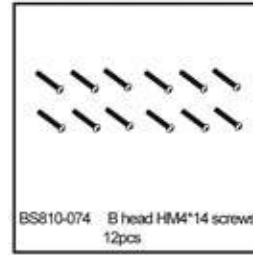
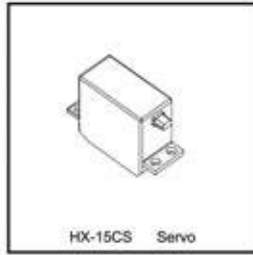
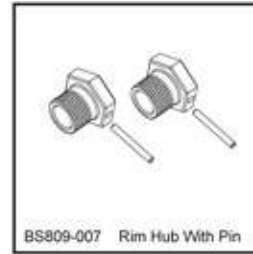
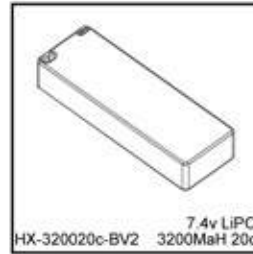
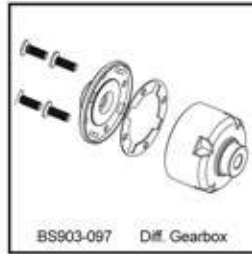
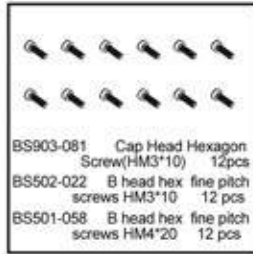
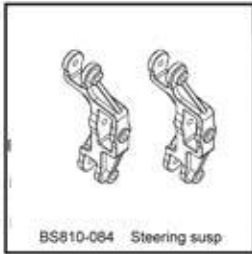



FAST TM AFFORDABLE TM FUN

www.redcatracing.com

MAN-TERREMOTO10V2-2016.4.13

•To ensure that you are using the most recent version of this manual:

www.redcatracing.com/manuals/TERREMOTO10MANUAL.pdf

•To ensure that you have the most recent version of the Electronic Vehicles Manual:

www.redcatracing.com/manuals/ELECTRIC-MANUAL.pdf