

REDCAT-RACING

*1/6 SCALE 4WD ELECTRIC POWERED BRUSHLESS BUGGY
MODEL: SHREDDER-XB*



Product Features:

Length: 688mm

Width: 430mm

Height: 250mm

Wheelbase: 480mm

Tire size: 150/70mm

Motor: KV1500

ESC: EZRUN-80A

Instruction Manual

Highlights:

- Four wheel drive
- Motor: high performance brushless motor KV1500
- Brushless electronic speed controller 80A
- Twin 7.4V 3200mAh 20C lipo batteries
- 6061 T6 3mm aluminium alloy, fully assembled
- Auto-shift 3 diff transmission
- Independent, colored coil spring damped suspension arms
- 2.4GHz radio system
- Adjustable threaded oil-filled shock absorbers
- Sealed, water-proof and dust proof gear boxes
- Diff gears with four bevel gears
- Ball bearing mounted on model

⚠ SAFETY PRECAUTIONS

- This radio controlled racing car is not a toy!
- This high-performance R/C model is recommended for ages 14 and older.
- First-time builders should seek the advice of experienced modellers before commencing assembly.
- Take enough safety precautions prior to operating this model.
You are responsible for this model's assembly and safe operation!

www.redcatracing.com

Required equipment for operation

1. Tools required for building and maintenance:

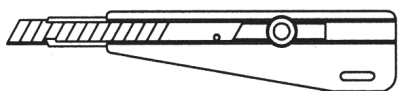

● Hobby knife

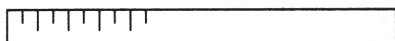

● Precision ruler

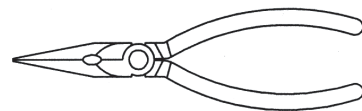

● Needle nose pliers

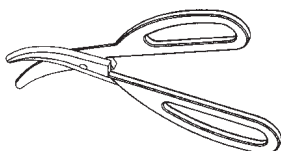

● Lexan scissors

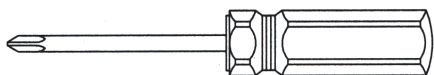

● Flat and Philips screwdriver

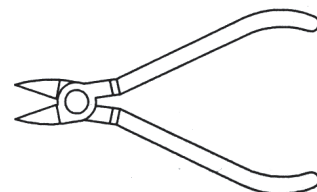

● Wire cutters

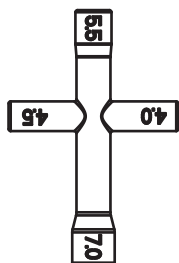

● Cross wrench



● Cross wrench



● CA glue & rubber cement



● Thread locking compound



2.0mm



2.5mm



3.0mm

● Hex wrench

WARNING!

Do not use a power screw driver to install screws into nylon or plastic materials. The fast locking may heat up the screws being installed that may break the molded parts or strip the threads during installation.

2. Additional items needed for operation:

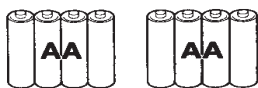

8pcs AA alkaline batteries for transmitter

IMPORTANT!

Check all the screws are tight before playing the vehicle!
Use thread lock on all screws that work loose.

Please read the instruction carefully before starting the assembly.

1. Please assemble and install this car without children's reach. As it includes small and sharp parts.
2. Do not run the car on public streets or highways. As it might cause serious accidents, personal injuries and property damage etc.
3. During the middle of racing and after operation, the engine and exhaust will become HOT. Therefore please do not touch them before cooling down.
4. Please make sure everyone is using different frequencies while racing the car in the same area.

2.4GHz radio instructions

Special symbols

Please pay attention to the following symbols, and read them carefully.



Danger: If the operator does not operate according to the instructions, it may lead to serious injuries, even mortal danger.



Warning: If the operator does not operate according to the instructions, it may lead to serious injuries, even mortal danger.



Attention: If the operator does not operate according to the instructions, it may lead to serious injuries, even mortal danger. but generally it will not cause serious injuries to the operator.

Safety guidelines

Don't drive the truck at night, bad weather such as rainy or thundering days. It will interfere the transmitter signal. Thereby it will cause out of control and unexpected accident.

Before you drive, please make sure the movement of servo corresponds with the direction of joysticks. If inconsistent, please adjust before drive.

You need to turn the throttle channel(ch2) and inching switch to the lowest before use. Then switch on the transmitter power, finally connect the receiver.

The sequence to shutdown is to turn off the receiver power first, and then the transmitter power.

If the above operations are reversed, it might lead to out of control and cause accident.

Battery charging



If your transmitter, receiver use a nickel-cadmium, nickel-metal hydride rechargeable battery, you have to check it before use. If lack of electricity, it could cause inadequate control or out of control, resulting in accident. So please charge it immediately when the battery power is low.

Transmitter Specifications :

Channels: 2 channels
 Model Type: Car/boat
 RF Power: Less than 20dbm
 Modulation: GFSK
 Code Type: Digital
 Sensitivity: 1024
 Low Voltage Warning: Yes (less than 9V)
 DSC Port: Yes (3.5mm)
 Charger Port: Yes
 Power: 12vdc (1.5AA*8)
 Weight: 328g
 ANT Length: 26mm
 Size: 159*99*315mm
 Color: Black
 Certificate: CE FCC

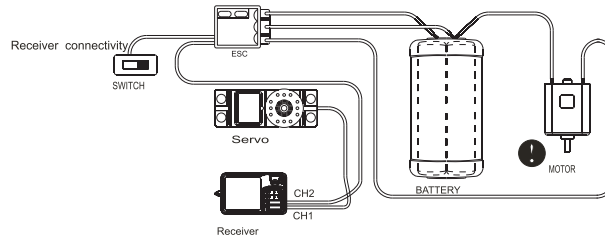
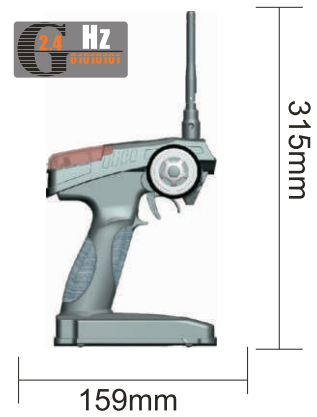

Note:

Place the antenna of the receiver vertically, and do not have contact with metal component. (See Figure1)

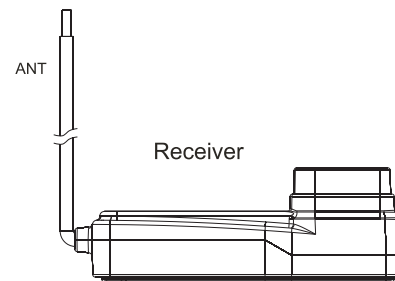

Figure 1

Binding:

The transmitter and receiver should already be bound by the factory by default .

1. Install batteries into the transmitter and shut it down.
2. Insert the bind cable on to the bind channel (Ch3) on the receiver. (Figure.2)
3. Connect the receiver battery to the VCC port on the receiver .The two LEDs on the receiver should flash rapidly, indicating the receiver is in binding state .
4. Press and hold the bind button on the transmitter , and then turn on the transmitter.
5. The LED on the receiver should stop flashing when the binding process completed (about 5 second)
6. Release the bind button on the transmitter , remove the bind cable from the receiver.
7. Install the servo and then test.
8. If the test succeeds , then remove the power supply from the VCC port.
9. The binding process completed.

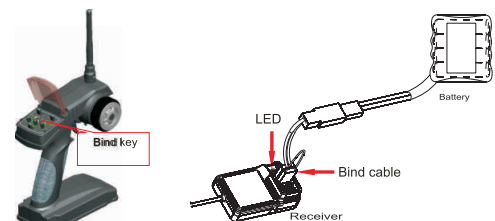
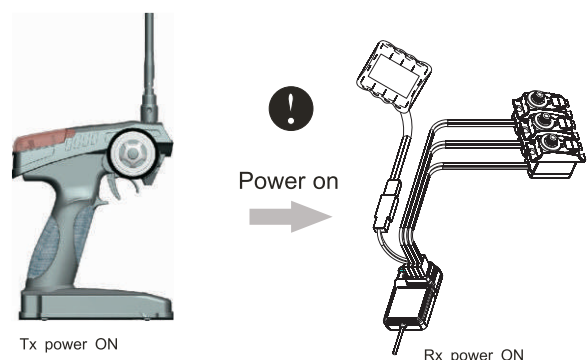

Figure 2

Turn On:

1. Turn on the transmitter.
2. Connect the power supply of the receiver.
3. Receiver LED light should turn solid.
4. Ready to use.



Shut Down:

1. Disconnect the receiver's power supply.
2. Turn off the transmitter .

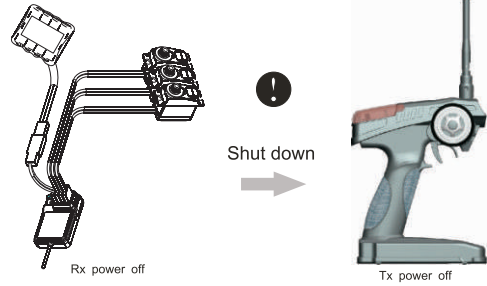

Transmitter Functions:

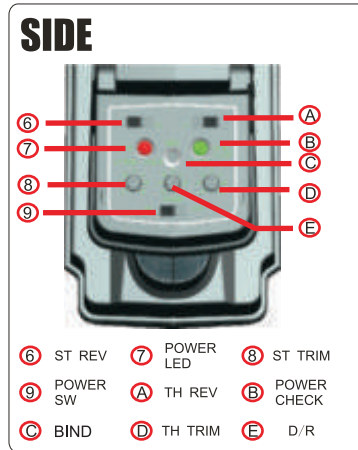
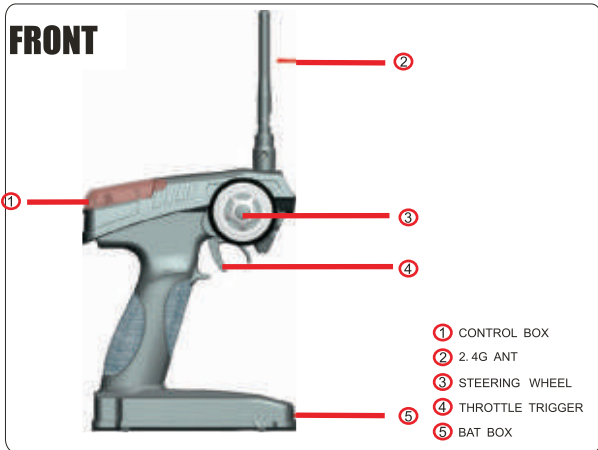

This function is to control the direction of the vehicle

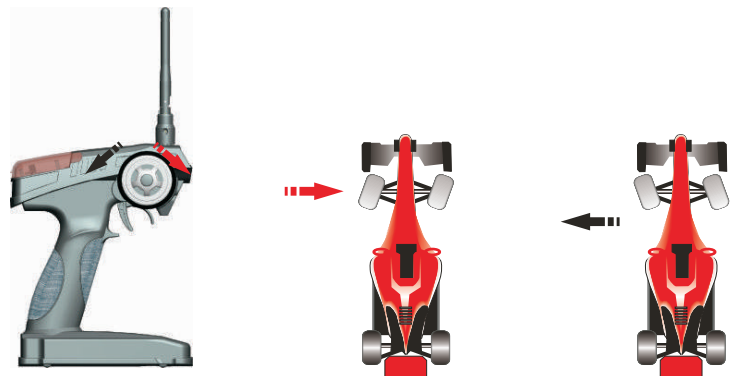

This function is to control the throttle speed of the vehicle

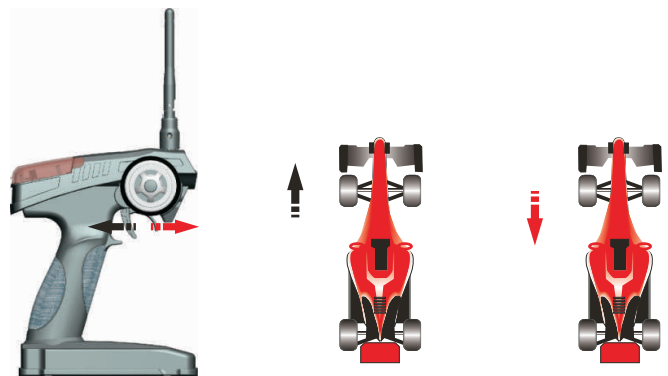

PARTS LIST

Item No.	Description	Item No.	Description
BS502-001	Tire Unit 2pcs	BS903-011	Upper susp. Arm mount-Fr/Rr
BS502-002	Chassis	BS903-014	Ball bearing(6*12*4) 2pcs
BS502-003	Shock Absorber Unit	BS903-016	Ball bearing(10*15*4) 2pcs
BS502-004	Susp.Arm Unit Lf/Rt	BS903-024	Front suspension arm pin-short 4pcs
BS502-005	Fr.Lower Susp.Arm-Lf/Rt	BS903-025	Suspension arm pin-long 4pcs
BS502-006	Rr.Lower Susp.Arm-Lf/Rt	BS903-026	Fr. Chassis
BS502-007	Drive shaft set 2pcs	BS903-028	Lower susp. Mount block-Fr/Rr
BS502-008	Steering Link unit	BS903-029	Anti-Roll Bar Fixation Set
BS502-009	Servo Link Unit	BS903-038	Steering servo mount-A/B
BS502-010	Centre Drive Shaft-Fr	BS903-058	Hub rear carrier
BS502-011	Centre Drive Shaft-Rr	BS903-061	Rear suspension arm pin-short
BS502-012	Upper Deck-Fr	BS903-065	(TPF2.6*10) Flat cross screw 12pcs
BS502-013	Upper Deck-Rr	BS903-081	(HM3*10) Cap head hexagon screw 6pcs
BS502-014	Anti-Roll Bar Set	BS903-083	Diff.outdrive C/set screw
BS502-015	Brushless Motor KV 1500	BS903-086	Ball bearing(5*10*4) 2pcs
BS502-017	TM3*10mm B-Head Hex Screw 12pcs	BS903-087	Ball bearing(12*18*4) 2pcs
BS502-018	C Hub Unit (Lf)	BS903-089	Pin(2*9.5) 12pcs
BS502-019	C Hub Unit (Rr)	BS903-091	Washer A(5.2*10*0.2) 12pcs
BS502-020	Motor gear /Grub Screw	BS903-092	Washer B(4.2*8*0.2) 12pcs
BS502-021	Fr/Rr Steering Arm	BS903-094	Double way ball end 6pcs
BS502-022	HM3*10mm B-Head Hex Screw 12pcs	BS903-095	(M4*4) Set Screw 6pcs
BS502-023	HM3*12mm B-Head Hex Screw 12pcs	BS903-097	Diff. Gearbox
BS502-024	HM3*14mm B-Head Hex Screw 12pcs	BS903-098	Diff. Gearbox bulkhead-Upper/Lower
BS502-025	HM3*20mm B-Head Hex Screw 12pcs	BS903-106	Screw Pin (M3*9.5) 12pcs
BS502-026	HM3*8mm B-Head Hex Screw 12pcs	BS903-107	Antenna mount 3pcs
BS502-027	HM3*10mm Flat Hex Screw 12pcs	BS903-109	Diff.outdrive A/Pin(2*10)
BS502-028	HM3*8mm Flat Hex Screw 12pcs	BS903-110	Diff.outdrive B/Pin(2*10)
BS502-029	HM3*12mm Flat Hex Screw 12pcs	BS901-066	M3 locknut 5pcs
BS502-030	HM3*14mm Flat Hex Screw 12pcs	BS901-067	Antenna Pipe W/Cap
BS502-032	HM3*16mm B-Head Hex Screw 12pcs	BS902-051	(BT3*10)B-head hex screw 12pcs
BS502-033	HM3*30mm B-Head Hex Screw 12pcs	BS803-004	(ISO3*8) Flat hex screw 12pcs
BS903-005	Brace 1pcs	BS803-007	Battery base-L
BS903-007	Body Pin 6pcs	BS803-008	Battery base-R
BS903-009	Fr. bumper 1pcs	BS803-009	Left/right battery cover
BS903-010	Suspension arm mount block 2pcs	BS803-010	Servo saver unit

EXPLODED VIEW

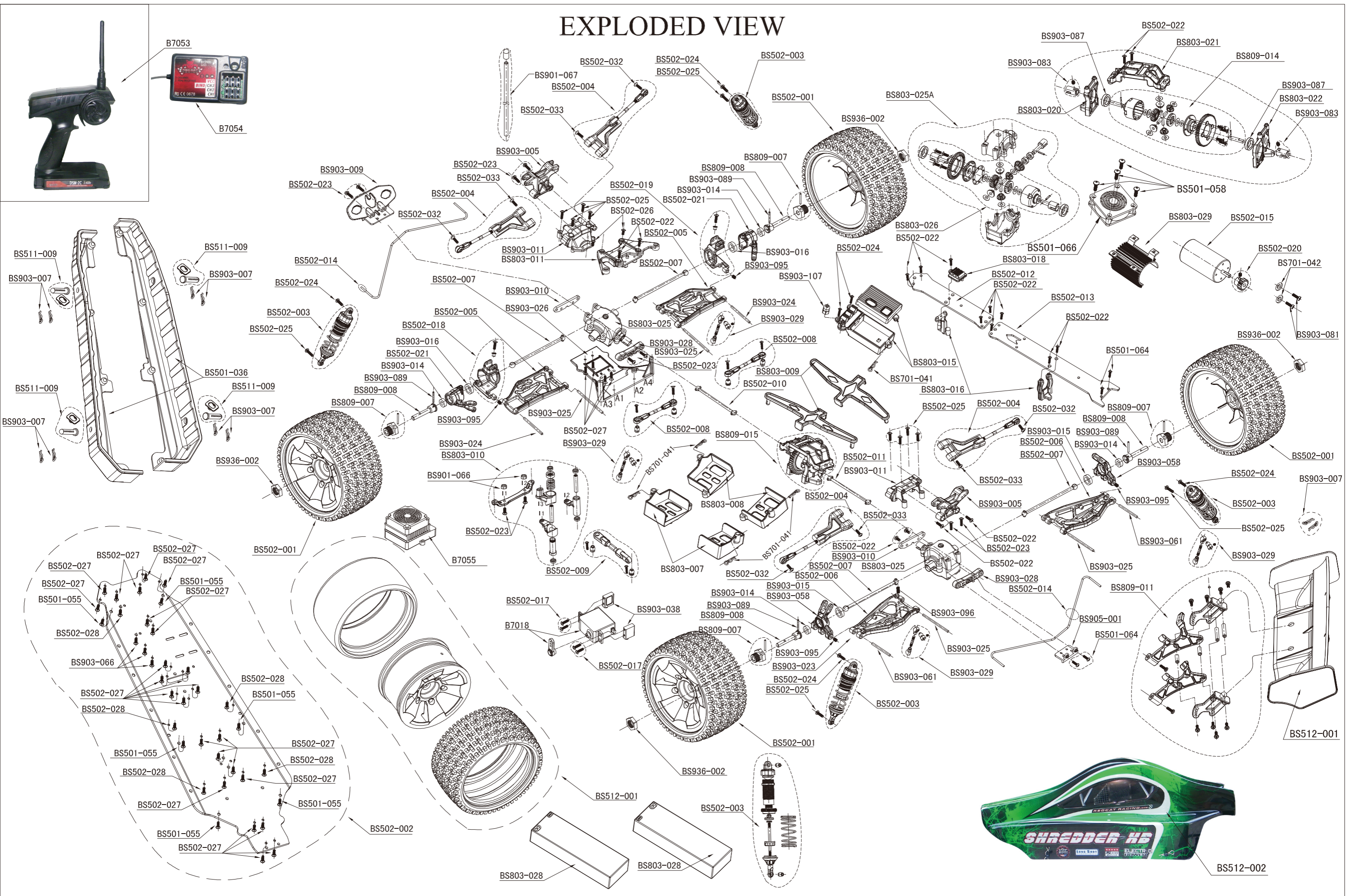

BS512-002

PARTS LIST

Item No.	Description
BS803-011	Upper deck-Fr
BS803-014	(BM3*14) B-head hex screw 12pcs
BS803-015	Receiver case-Upper/Lower
BS803-016	Front/rear upper deck mount
BS803-018	Wire mount
BS803-020	Centre diff mount
BS803-021	Centre Diff Cover
BS803-022	Motor mount
BS803-025A	Diff. gearbox unit
BS803-026A	Diff. Unit
BS803-028	7.4V/20C LiPo battery
BS803-029	Motor Heat Sink
BS808-005	Spur gear 49T
BS936-002	Nut M12 Spui gear LO9T
BS905-001	Rear chassis 1pcs
BS702-049	Rollcage beam 2pcs

Item No.	Description
BS701-042	Slipper hub A 1pcs
BS809-007	Rim Hub
BS809-008	Axle W/Pin
BS809-011	Rear wing mount 1pcs
BS809-014	Diff unit
BS809-015	Centre Diff. Unit
BS501-036	Side Guard Plate-L/R
BS501-055	HM4*12mm B-Head Hex Screw 12pcs
BS501-066	Cooling Fan
BS501-058	HM4*20 B-Head Hex Screw 12pcs
BS511-009	Body mount 4pcs
BS512-001	Wing 1pcs
BS512-002	Body 1pcs
B7018	9KG Servo
B7055	Brushless ESC 80A
B7053	2.4G Transmitter
B7054	2.4G Receiver

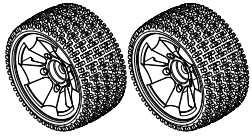

BS502-001 Tire Unit 2pcs

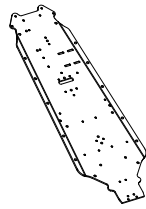

BS502-002 Chassis

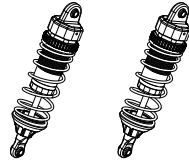

BS502-003 Shock Absorber Unit

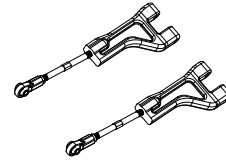

BS502-004 Susp. Arm Unit Lf/Rt

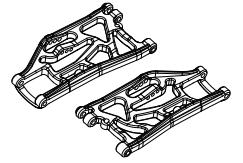

BS502-005 Fr. Lower Susp. Arm-Lf/Rt

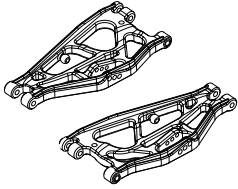

BS502-006 Rr. Lower Susp. Arm-Lf/Rt

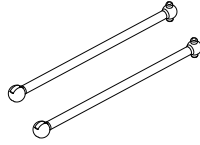

BS502-007 Drive shaft set 2pcs

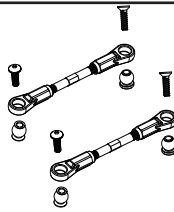

BS502-008 Steering Link unit

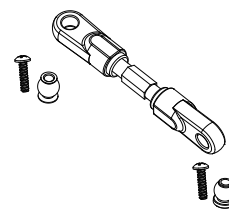

BS502-009 Servo Link Unit

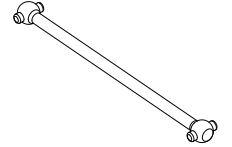

BS502-010 Centre Drive Shaft-Fr

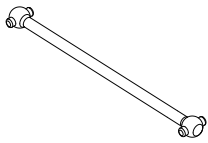

BS502-011 Centre Drive Shaft-Rr

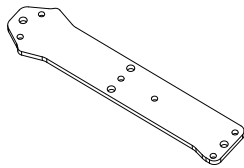

BS502-012 Upper Deck-Fr

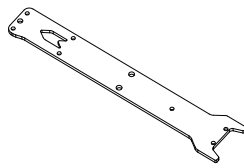

BS502-013 Upper Deck-Rr

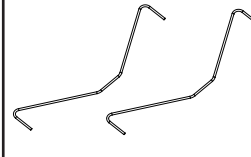

BS502-014 Anti-Roll Bar Set

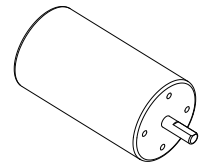

BS502-015 Brushless Motor KV1500



BS502-017 TM3*10mm B-Head Hex Screw 12pcs

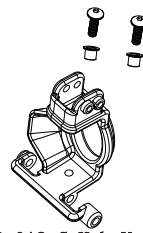

BS502-018 C Hub Unit(Lf)

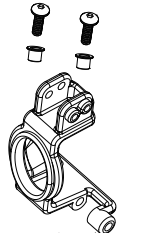

BS502-019 C Hub Unit(Rr)

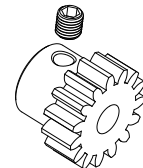

BS502-020 Motor gear /Grub Screw

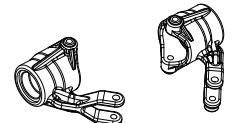

BS502-021 Fr/Rr Steering Arm



BS502-022 HM3*10mm B-Head Hex Screw 12pcs



BS502-023 HM3*12mm B-Head Hex Screw 12pcs



BS502-024 HM3*14mm B-Head Hex Screw 12pcs



BS502-025 HM3*20mm B-Head Hex Screw 12pcs

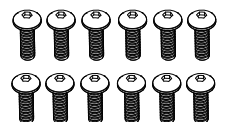

BS502-026 HM3*8mm B-Head Hex Screw 12pcs



BS502-027 HM3*10mm Flat Hex Screw 12pcs



BS502-028 HM3*8mm Flat Hex Screw 12pcs



BS502-029 HM3*12mm Flat Hex Screw 12pcs



BS502-030 HM3*14mm Flat Hex Screw 12pcs



BS502-032 HM3*16mm B-Head Hex Screw 12pcs



BS502-033 HM3*30mm B-Head Hex Screw 12pcs

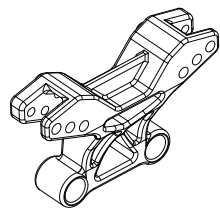

BS903-005 Shock tower

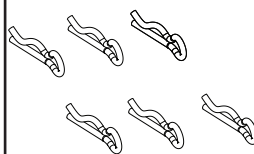

BS903-007 Body pin 1.5 6pcs

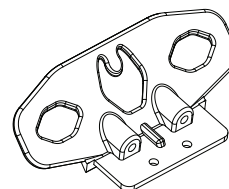

BS903-009 Fr. bumper 1pcs

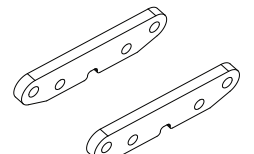

BS903-010 Suspension arm mount 2pcs

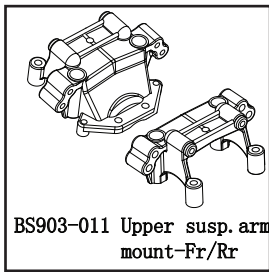

BS903-011 Upper susp. arm mount-Fr/Rr

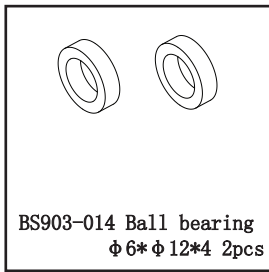

BS903-014 Ball bearing $\phi 6*\phi 12*4$ 2pcs

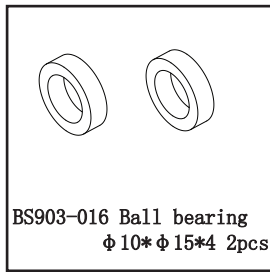

BS903-016 Ball bearing $\phi 10*\phi 15*4$ 2pcs

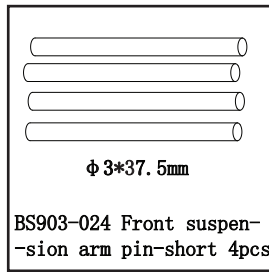

BS903-024 Front suspension arm pin-short 4pcs

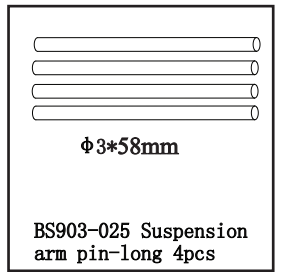

BS903-025 Suspension arm pin-long 4pcs

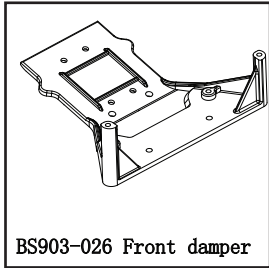

BS903-026 Front damper

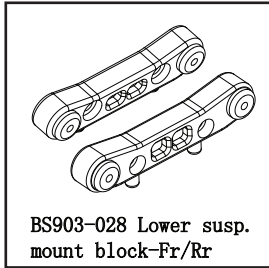

BS903-028 Lower suspension mount block-Fr/Rr

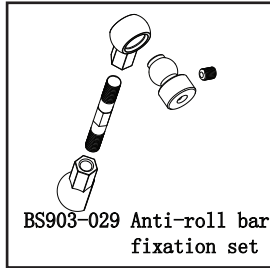

BS903-029 Anti-roll bar fixation set

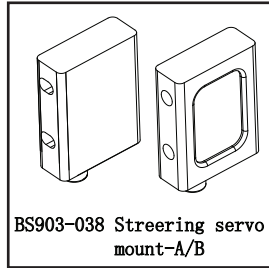

BS903-038 Steering servo mount-A/B

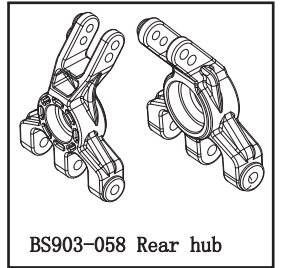

BS903-058 Rear hub

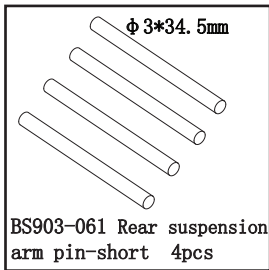

BS903-061 Rear suspension arm pin-short 4pcs

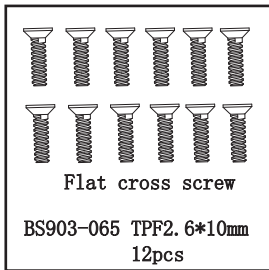

BS903-065 TPF2.6*10mm 12pcs

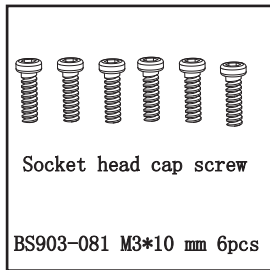

BS903-081 M3*10 mm 6pcs

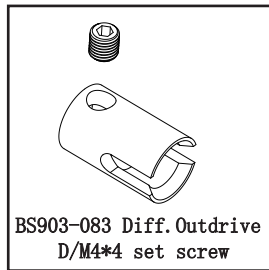

BS903-083 Diff. Outdrive D/M4*4 set screw

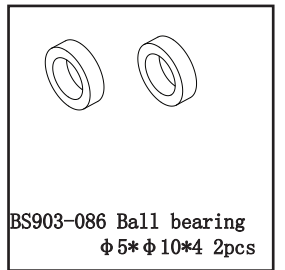

BS903-086 Ball bearing $\phi 5*\phi 10*4$ 2pcs

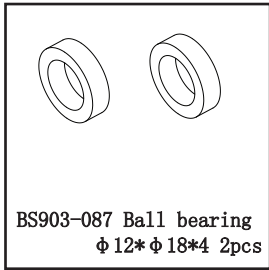

BS903-087 Ball bearing $\phi 12*\phi 18*4$ 2pcs

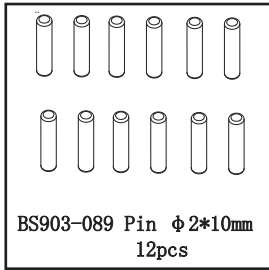

BS903-089 Pin $\phi 2*10$ mm 12pcs

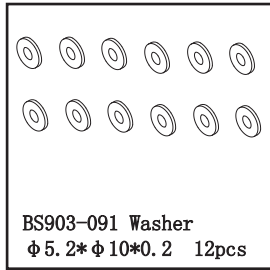

BS903-091 Washer $\phi 5.2*\phi 10*0.2$ 12pcs

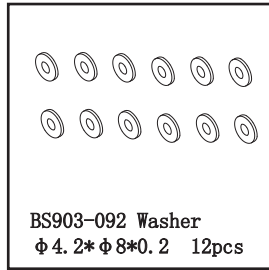

BS903-092 Washer $\phi 4.2*\phi 8*0.2$ 12pcs

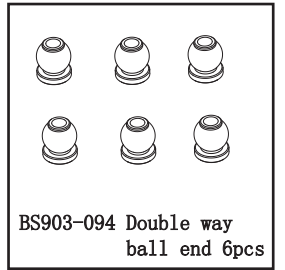

BS903-094 Double way ball end 6pcs

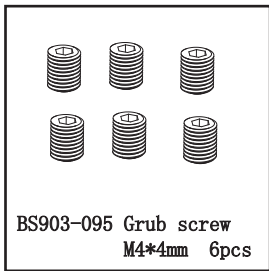

BS903-095 Grub screw M4*4mm 6pcs

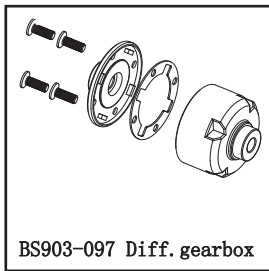

BS903-097 Diff. gearbox

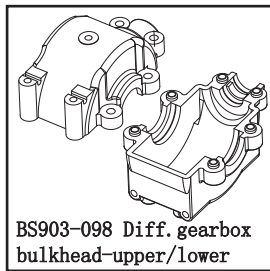

BS903-098 Diff. gearbox bulkhead-upper/lower

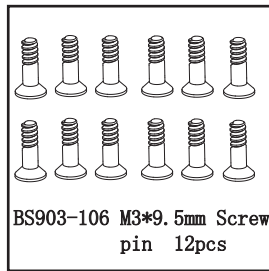

BS903-106 M3*9.5mm Screw pin 12pcs

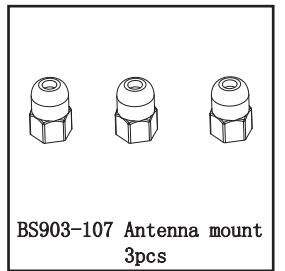

BS903-107 Antenna mount 3pcs

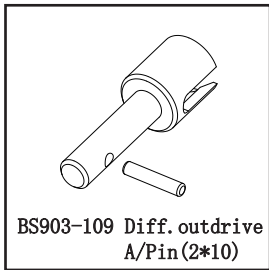

BS903-109 Diff. outdrive A/Pin(2*10)

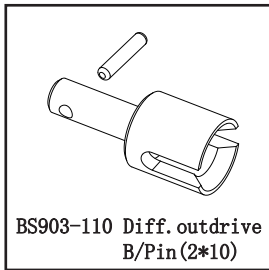

BS903-110 Diff. outdrive B/Pin(2*10)

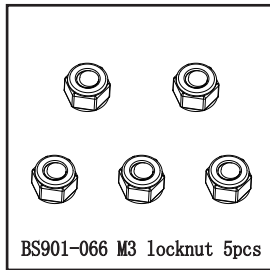

BS901-066 M3 locknut 5pcs

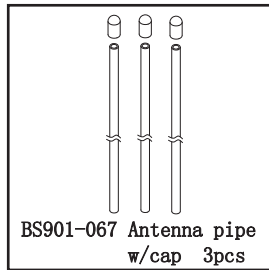

BS901-067 Antenna pipe w/cap 3pcs

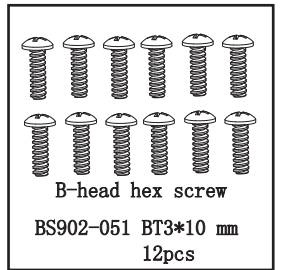

BS902-051 BT3*10 mm 12pcs

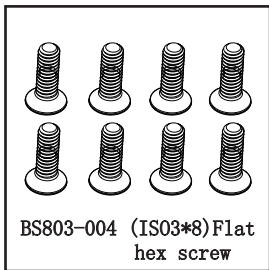

BS803-004 (IS03*8) Flat hex screw

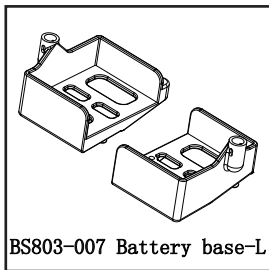

BS803-007 Battery base-L

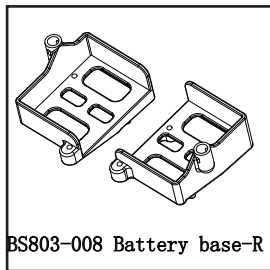

BS803-008 Battery base-R

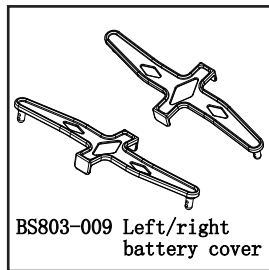

BS803-009 Left/right battery cover

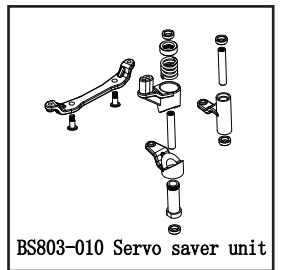

BS803-010 Servo saver unit

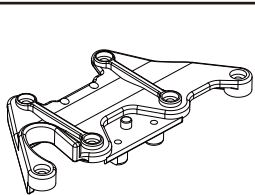

BS803-011 Upper deck-Fr

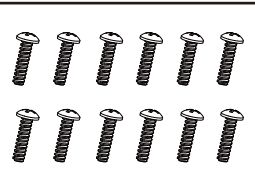

BS803-014 (BM3*14)
B-head hex screw 12pcs

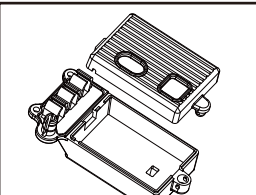

BS803-015 Receiver case-Upper/Lower

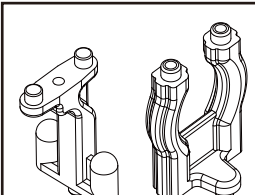

BS803-016 Front/rear upper deck mount

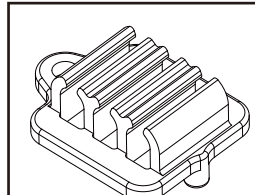

BS803-018 Wire mount

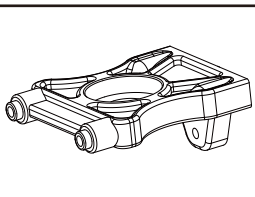

BS803-020 Centre diff mount

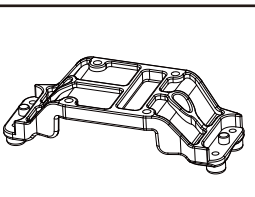

BS803-021 Centre Diff Cover

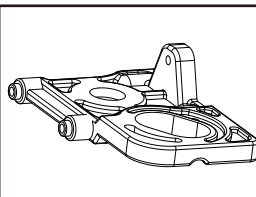

BS803-022 Motor mount

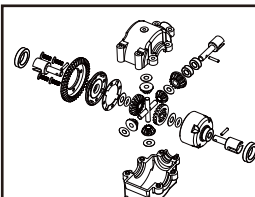

BS803-025A Diff. gearbox unit

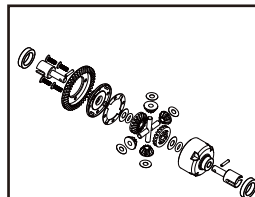

BS803-026A Diff. Unit

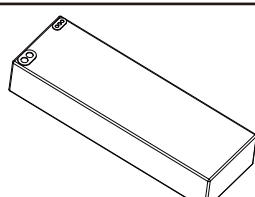

BS803-028 7.4V/20C LiPo battery

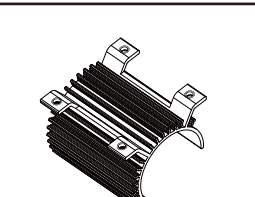

BS803-029 Motor Heat Sink

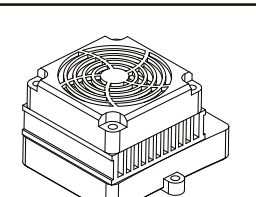

B7055 Brushless ESC 80A

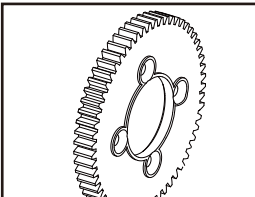

BS808-005 Spur gear (49T)

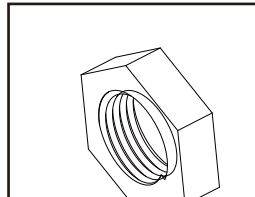

BS936-002 Nut M12

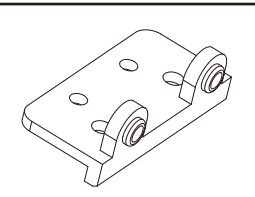

BS905-001 Rear chassis

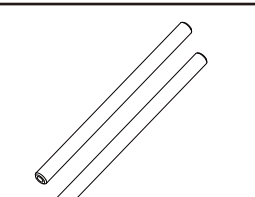

BS702-049 Main frame shaft

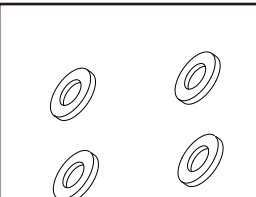

BS701-042 Slipper hub A 1pcs

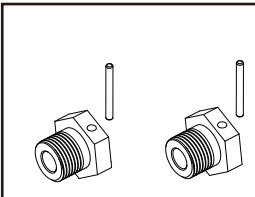

BS809-007 Rim Hub

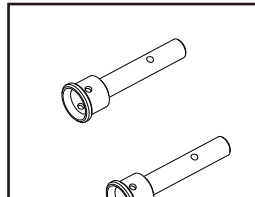

BS809-008 Axle W/Pin

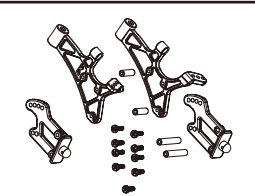

BS809-011 Wing mount (Lf/Rt) Bushing & screws

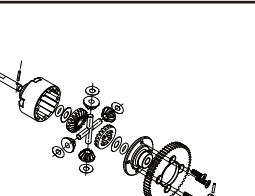

BS809-014 Diff unit 1pcs

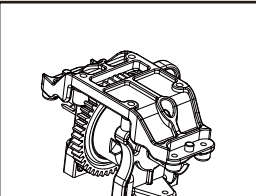

BS809-015 Centre Diff. Unit

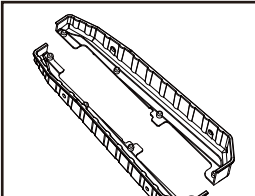

BS501-036 Side Guard Plate-L/R

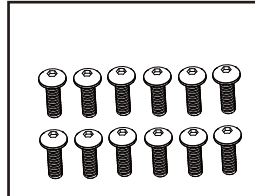

BS501-055 HM4*12mm B-Head Hex Screw 12pcs

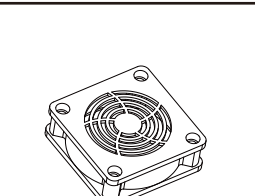

BS501-066 Cooling Fan

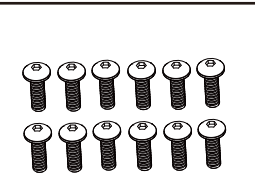

BS501-058 HM4*20mm B-Head Hex Screw 12pcs

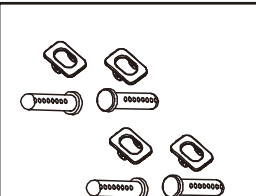

BS511-009 Body mount 4pcs

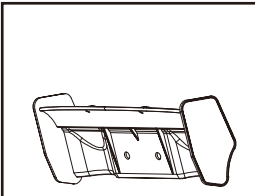

BS512-001 Wing 1pcs



BS512-002 Body 1pcs

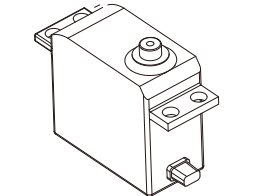

B7018 9kg servo



B7053 Transmitter complete



B7054 Receiver 1pcs



Precautions and Warnings for Use and Handling of Lithium Polymer Battery

Preface

In order to get the optimum performance and reliable safety, consumers shall read and take the following instructions and precautions when use and handle the Lithium Polymer (Li-Po) batteries.

1. Charging

1-1 Charging current should not be more than the maximum charge current specified in the Product Specification (normally 0.5C-1.0C or lower). Charging with higher current may damage the cell or even lead to safety problem, e.g. overheating or leakage.

1-2 Charging voltage shall not be more than that specified in the Product Specification (4.2V/cell). 4.25V is the maximum charging voltage for each cell. Never charge the battery in series and be sure that each single cell has a separated charging circuit with a max. charging voltage of 4.25V. Or the battery may be overcharged, and lead to fire or explosion. The user is fully responsible to the result of misusing the battery.

1-3 Charging temperature: The cell should be charged within the range of temperatures specified in the Product Specification. Stop charging immediately when the surface temperature of the battery is over 50°C.

1-4 Reverse charging: Please make sure the polarities of cells are connected properly before charging. Reverse charging is strictly prohibited. Reverse charging cannot charge the cells but will deteriorate their charging/discharging and safety characteristics, or even lead to fire or explosion.

2. Discharging

2-1 Discharging current: The cell shall be discharged at the current no more than the maximum discharging current specified in the Product Specification. Over current discharging may damage the battery and cause over-heat.

2-2 Operation temperature: Use the battery within the temperature range specified in the Product Specification. Stop using when temperature is over 70°C.

2-3 Over-discharging: Over-discharging will deteriorate the cell's performance and characteristics. Do not over-discharge a battery below 2.75V/cell.

3. Storage

If you intend to keep the battery for a long time (3 months or longer), it is strongly recommended that the battery shall be stored under the environment with temperature 10-25°C, low humidity and without corrosive gas. The battery should be charged every six months to ensure that each cell's storage voltage is 3.6~3.9V.

Others

>The aluminum packing foil is very soft that it will be easily left scratches. Please do not hit the cell with any sharp edge parts.

>Don't fall, hit or bend the battery. It may cause fire or explosion.

>Short circuit the battery is strictly prohibited, it may damage the battery seriously.

>Never disassemble the battery. It may cause fire.

>Never dispose of the battery in fire. It is very dangerous and strictly prohibited.

>To place the battery into liquid such as water is strictly prohibited.

>Always remove battery from car when charging. Charging the battery in a car is forbidden and is dangerous.

>Avoid vibration, shock or extruding the battery. Handle carefully when moving it.

Redcat Racing

<http://www.redcatracing.com>