

ASCENT

1/10 LCG Crawler



INCLUDED

Ascent: Assembled with electronics
Radio System: 2.4GHz

REQUIRED

Rechargeable Battery: 2S/3S LIPO Battery / 6-Cell NiMH Battery
Battery Charger: Suitable for battery being used
Transmitter Batteries: Four AA batteries

IMPORTANT LINKS:

- To view the full length manual with ESC guide, Radio guide, exploded views and parts lists, go to: www.redcatracing.com/pages/manuals
- Link to electric vehicles manual:
www.redcatracing.com/manuals/ELECTRIC-MANUAL.pdf



Warnings

AGE WARNING! You must be 14 years of age or older to operate this vehicle. It is the buyer's responsibility to ensure that this product is safely operated. This radio controlled (RC) vehicle is not a toy. It is the responsibility of the parents or guardian to ensure that minors receive appropriate guidance and supervision when operating or working on this product.

The buyer assumes all risks associated with the use of this product. Namero LLC d/b/a Redcat Racing and their retail partners, dealers, distributors, manufactures and affiliates cannot control the use and operation of this product and as such shall not be held responsible or liable for any injury, accident or damage resulting from the use of this product.

Always perform a prerun inspection to ensure that there is no damage and that all screws and wheel nuts are secure. If damage is found, repair or replace prior to use.

Fully read all instructions, manuals and warnings that come with your RC vehicle and any accessories required to operate the product.

Never operate your RC vehicles on public roads, near bystanders, children, pets other animals. Never lose sight of your vehicle while it is in operation and always leave a safe distance around your RC vehicles when driving so that in the event you lose control you don't damage the vehicle, hurt yourself or others. Always keep clear of the wheels or other moving parts on the vehicle and never attempt to pick up the vehicle if the wheels are in motion. Do not attempt to touch the motor, ESC, battery or other electrical components during or immediately after use as these items will get hot during operation.

Always allow the vehicle time to cool down between runs. Overheating the electronics can shorten the life of your electronic components.

Never leave the battery connected when not in use and store batteries in accordance with the manufactures instructions.

Never leave a battery unattended while being charged. Never charge batteries while they are inside of the RC vehicle.

There is a risk of fire and explosion when dealing with batteries. Rechargeable batteries may become hot and catch fire if left unattended, charged too quickly, charged too often, if overcharged, if over discharged or if previously damaged. Never charge at a rate higher than 1C. (2000Mah pack = 2 amp charge rate). Always use a LIPO safe charging pouch when charging LIPO batteries. Only use a LIPO specific charger when charging LIPO batteries.

Never use a LIPO battery that has previously overheated and/or shows signs of damage or swelling. If you suspect the battery to be damaged, immediately discontinue use and properly dispose of the battery. Never dispose of a LIPO battery with regular trash, check with local authorities for proper disposal.

Always check the ESC settings to ensure that they match the battery type during operation. If using a LIPO battery, the ESC must be set to LIPO or damage may occur.

Never mix old and new batteries. Do not change or charge batteries in a hazardous location. Do not mix alkaline, lithium, standard (carbon zinc), or rechargeable (NiMH, cadmium) batteries.

If you do not agree with or are unable to follow these warnings and are not willing to accept full and complete liability for the use of this RC product; immediately return the product to your place of purchase in new and unused condition.

Start Up

Attention: The ESC is set to LIPO from the factory.

Note: When using a LIPO battery, the ESC jumper clip **MUST** be set to LIPO or damage to the battery may occur.

Note: If using a NiMH battery, the ESC jumper clip must be set to NiMH.



Jumper Clip Position



1. Insert 4 brand new AA batteries into the controller. Be sure to line up the positive (+) side of the battery with the (+) mark inside the battery compartment. (see above warnings)

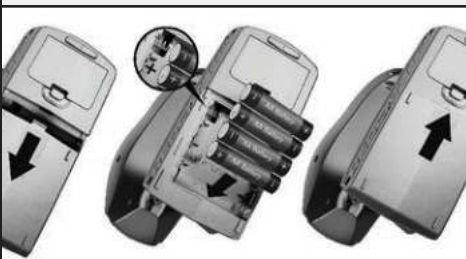

2. Remove the body clips and rotate the body forward. Unclip hinge to remove.



3. Strap in a fully charged battery pack.

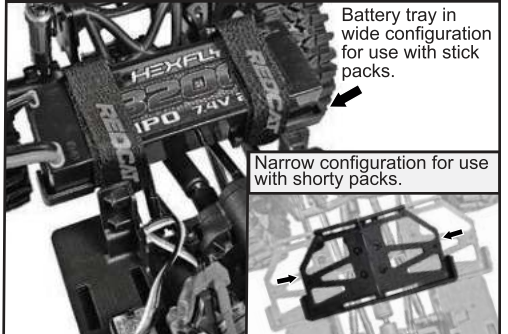

4. Plug in the battery. **CAUTION!** Do not turn on the ESC yet!

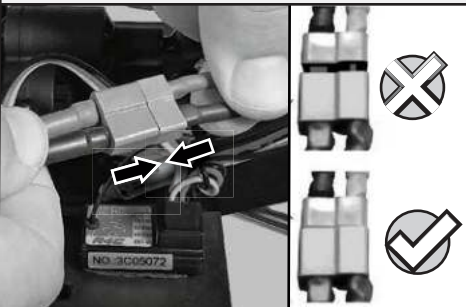

5. Turn on the radio.



6. Switch on the ESC and secure the body in place.

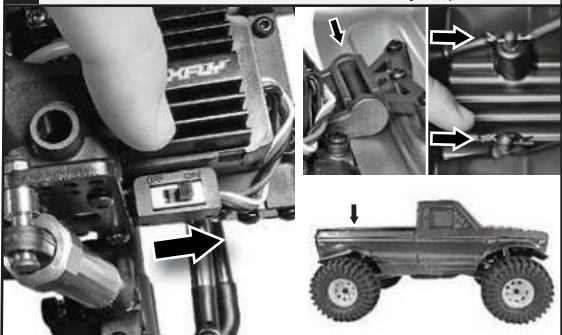

NOTE: You can also operate the ON/OFF switch by reaching under the front right fender.



Steering

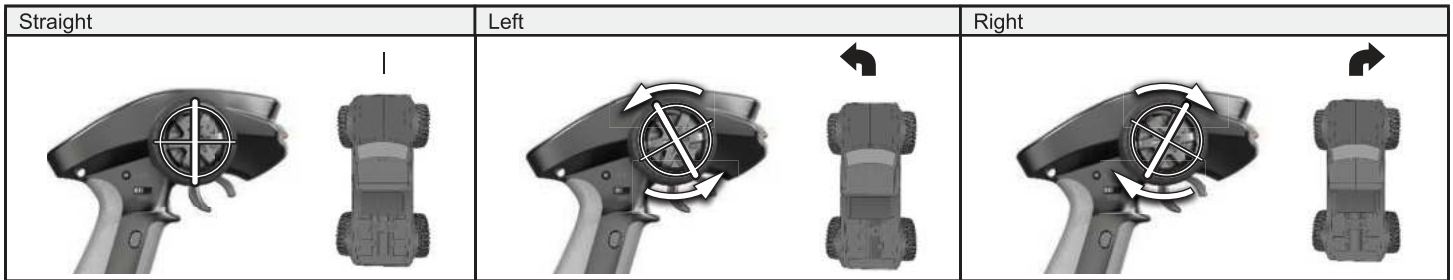

Throttle

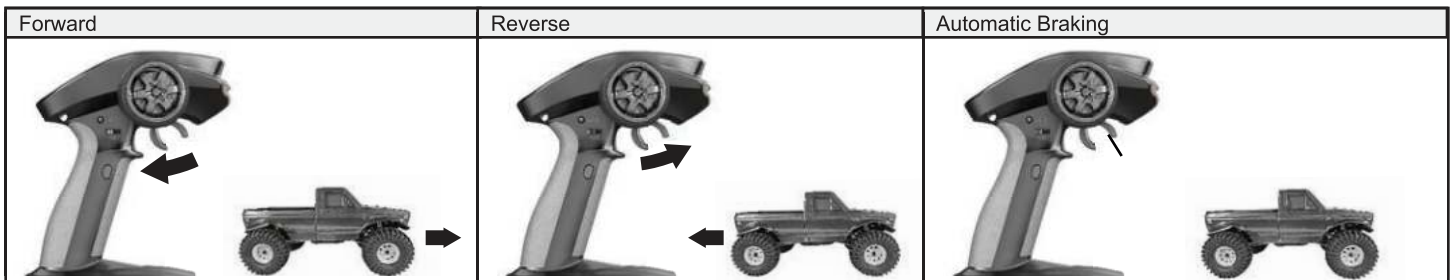

Shut Down

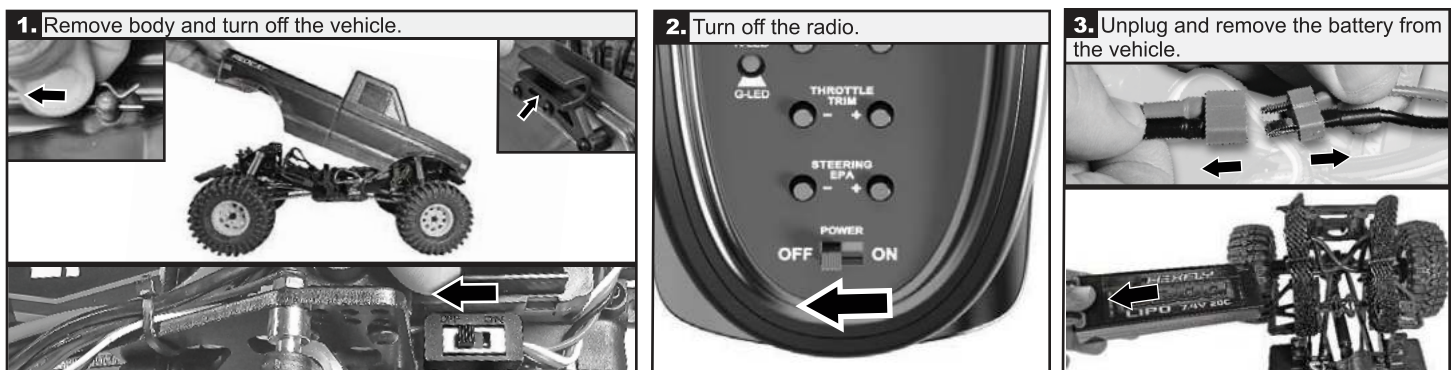

Radio Adjustments

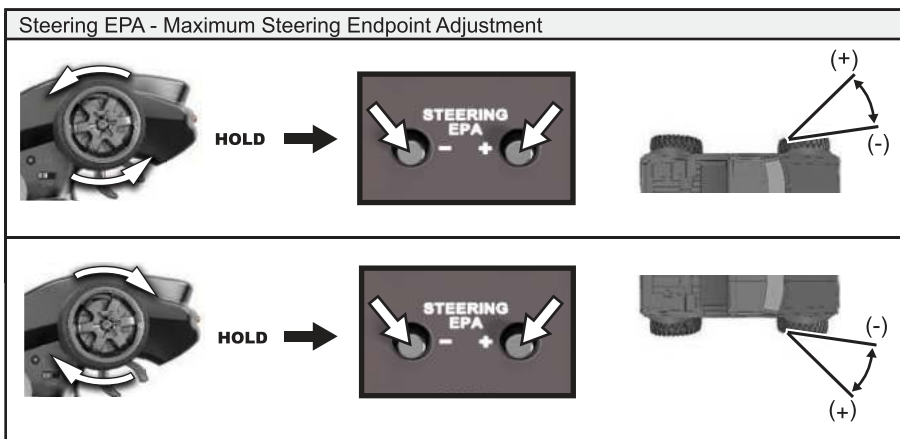
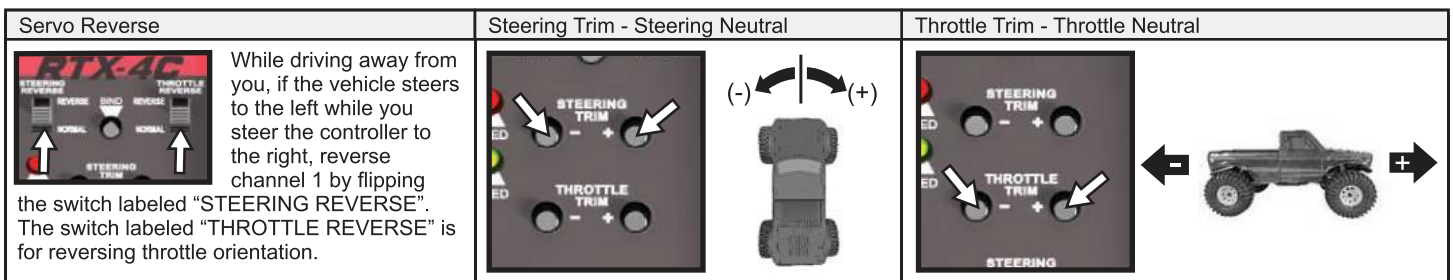

RTX-4C RADIO GUIDE

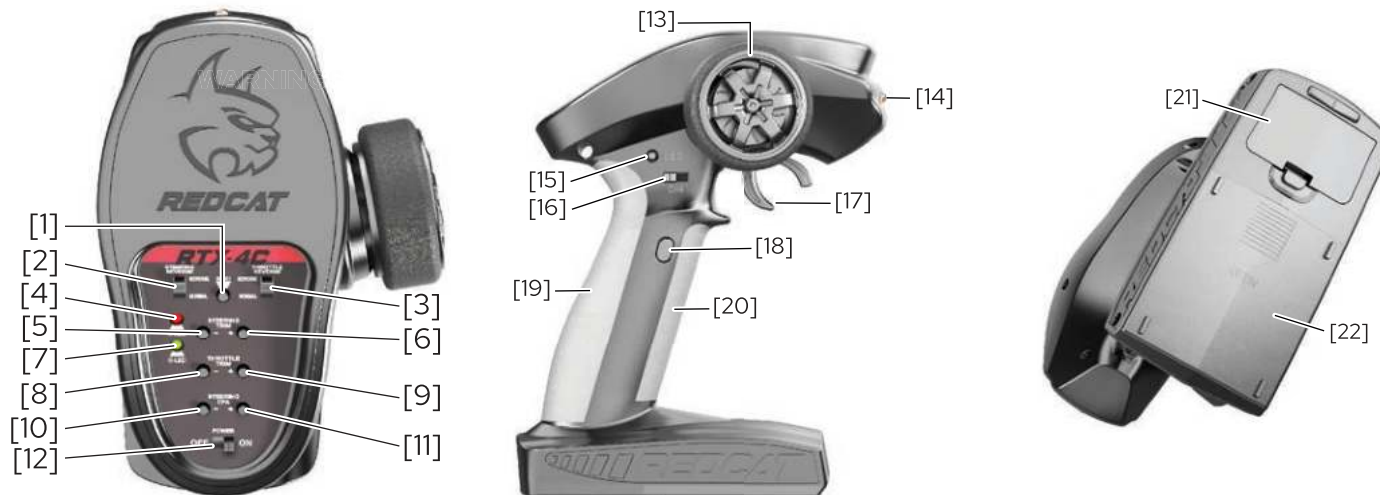

1. Bind Button	12. Power Switch
2. Steering Reverse	13. Steering Wheel (CH1)
3. Throttle Reverse	14. LED Light
4. Power Indicator LED - RED (R. LED)	15. LED Light (ON/OFF) Button
5. Steering Trim (-)	16. Three Position Switch (CH4)
6. Steering Trim (+)	17. Throttle Trigger (CH2)
7. Status Indicator LED - Green (G.LED)	18. Button (CH3)
8. Throttle Trim (-)	19. Rubber Grip Rear
9. Throttle Trim (+)	20. Rubber Grip Front
10. Steering End Point Adjustment (-) (EPA)	21. Tool & Spare Parts Compartment
11. Steering End Point Adjustment (+) (EPA)	22. Battery Compartment - 4 AA Batteries

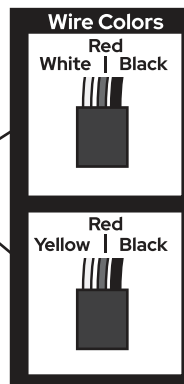
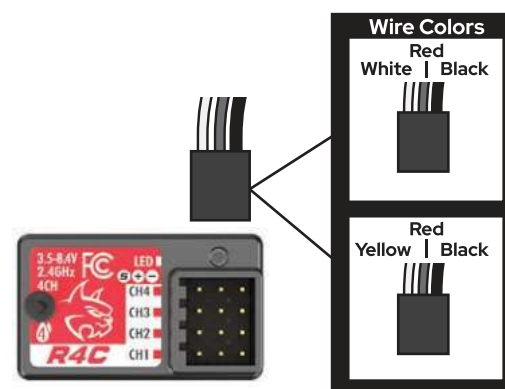

Warnings and Compliance



FCC Compliance Statement! The radio included with your vehicle complies with part 15 of the FCC Rules. Operation is subject to the following two conditions: (1) This device may not cause harmful interference, and (2) This device must accept any interference received, including interference that may cause undesired operations.

Note: This equipment has been tested and found to comply with the limits for a Class B digital device, pursuant to Part 15 of the FCC Rules.

These limits are designed to provide reasonable protection against harmful interference in a residential installation. This equipment generates, uses and can radiate radio frequency energy and, if not installed and used in accordance with the instructions, may cause harmful interference to radio communications. However, there is no guarantee that interference will not occur in a particular installation. If this equipment does cause harmful interference to radio or television reception, which can be determined by turning the equipment off and on, the user is encouraged to try to correct the interference by one of the following measures:

- Reorient or relocate the receiving antenna.
- Increase the separation between the equipment and receiver.
- Connect the equipment into an outlet on a circuit different from that to which the receiver is connected.
- Consult the dealer or an experienced radio/TV technician for help.

TX

FCC ID: 2A2UNRTX4C00

IC: 24025-RTX4C00

This device complies with Industry Canada license-exempt RSS standard(s). Operation is subject to the following two conditions: (1) This device may not cause interference, and (2) this device must accept any interference, including interference that may cause undesired operations of this device.

WARNING: Any changes or modifications not expressly approved by the party responsible for compliance could void the user's authority to operate this equipment.

WARNING: While operating the Radio, a separation distance of at least 20 centimeters must be maintained between the radiating antenna and the body of the user or nearby persons in order to meet the FCC RF exposure guidelines.

AFHDS (automatic frequency hopping digital system)

AFHDS was developed for Radio control models and offers active and passive anti-jamming capabilities, low power consumption and high receiver sensitivity.

This radio system works in the frequency range of 2.405 to 2.475GHz. This band has been divided into 141 independent channels. Each radio system uses 16 different channels and 142 different types of hopping algorithm. By using various switch-on times, hopping scheme, and channel frequencies, the system is less likely to lose transmission.

Each transmitter has a unique ID. When binding with a receiver, the receiver saves that unique ID and can accept only data from that unique transmitter.

This avoids picking another transmitter signal and dramatically increases interference immunity and safety.

WARNING: Even with the AFHDS 2A-BS technology, if the radio system is not used in accordance with this manual, it can still fail and cause serious injury. Be sure to read and understand this entire manual, as well as the manual that came with all other RC components you are using.



Receiver Connections

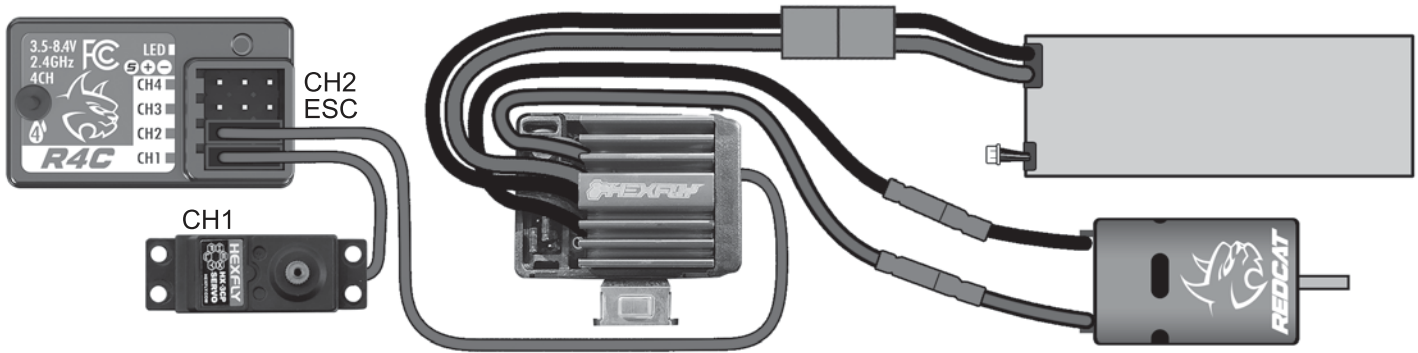

Binding Process

NOTE: The radio is already bound from the factory and only needs to be done if the receiver can't find the radio's signal. Before attempting to bind the radio, be sure there are new batteries in the radio, a fully charged battery pack in the vehicle and that both are turned on.

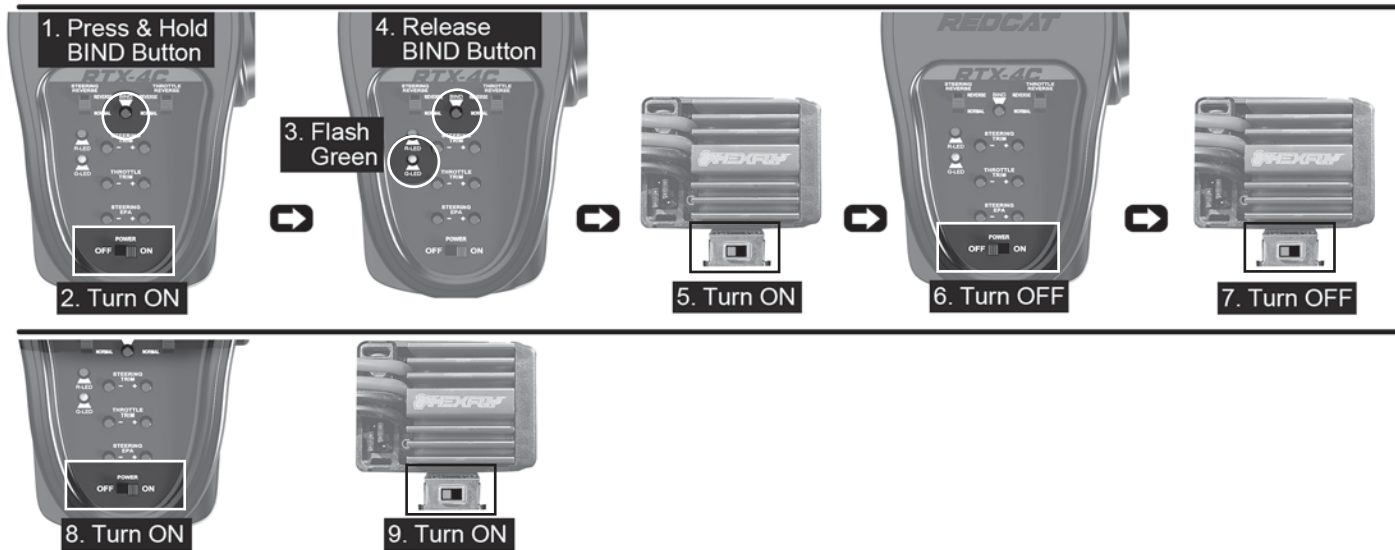
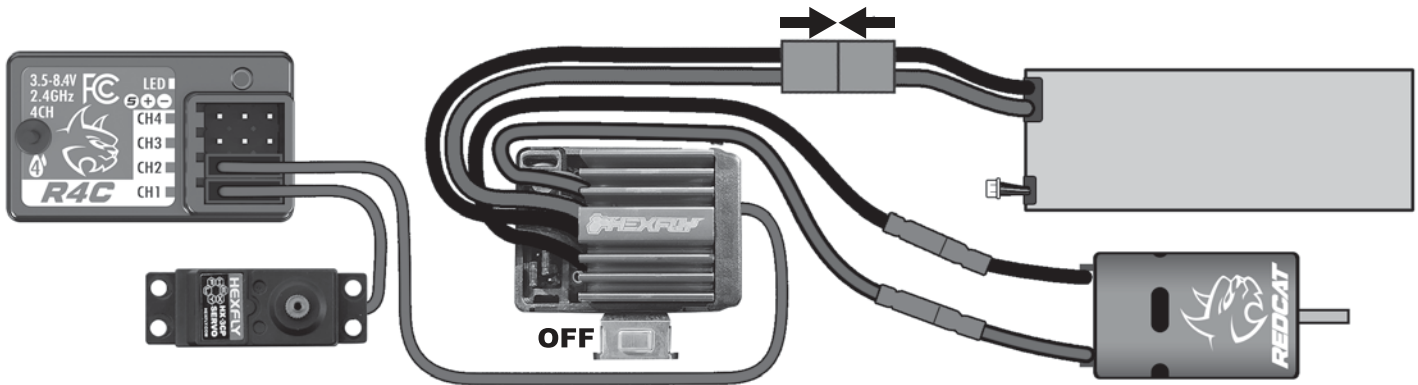

Calibration

This function is used to set the neutral position for the throttle trigger and steering wheel.

Every transmitter is calibrated before leaving the factory, however if recalibration is required, please follow these steps:

1. Turn and hold the wheel as far clockwise as it will turn, move the throttle trigger to the full reverse position and turn on the transmitter. If done correctly, both Red and Green LEDs will double flash on and off.
2. Calibrate wheel: Turn the wheel completely clockwise, then completely counterclockwise.
 - When calibration is completed the Red LED will turn off.
3. Trigger calibration: Pull the trigger to the full throttle position.
 - When calibration is completed the Green LED will turn off.
4. Once calibration is complete press the bind button to save the settings and exit calibration mode.

Radio Functions

-CHANNEL DESCRIPTION-

The transmitter outputs a total of 4 channels, which are allocated as follows:

CH1: Steering Wheel

CH2: Throttle Trigger

CH3: Accessory Button (2 Position button)

CH4: Accessory Switch (3 Position Switch)

Note: By default the output of CH3 is in the position of 1000us. Pressing the button will toggle between 1000 and 2000us.

-CHANNEL REVERSE-

This function is used to adjust each channel's direction of movement in relation to its input. The STEERING REVERSE and THROTTLE REVERSE switches directly effect CH1 and CH2. If the switch is up, the channel is reversed. If the switch is down, the channel is in its normal orientation.

-TRIMS-

The STEERING TRIM buttons are used to center the steering servo (CH1). If the vehicle steers without transmitter steering input, use these buttons to adjust the vehicle so that it drives straight without steering input from the transmitter. STEERING TRIM can be multiplexed to trim CH3 and CH4. For multiplexing instructions, refer to the [Mode Switching] section.

The THROTTLE TRIM buttons are used to ensure the vehicle remains still while there is no transmitter throttle input (CH2). If the vehicle drives forward or backward without transmitter throttle input, use these buttons to trim the throttle until the vehicle is completely still.

Adjustment range: -120us- + 120us, each step is 4us.

STEERING TRIM + / THROTTLE TRIM +: Increases adjustment steps.

STEERING TRIM- / THROTTLE TRIM -: Decreases adjustment steps.

LED Indicator:

- While using the trim buttons, the G.LED flashes slowly on short presses and quickly on long presses.
- When the trim adjustment value is in the neutral position, the G.LED will flash twice slowly.
- When the trim adjustment value is at its maximum setting (+ 120us / -120us), the G.LED will no longer flash with each press of the button, indicating it is at its maximum value.

-END POINT ADJUSTMENTS (EPA)-

STEERING EPA is used to set the steering servo's maximum amount of travel. This is used to ensure the steering servo provides enough throw to steer the front wheels to their maximum capacity without damaging the servo. To set the steering end points, press the "STEERING EPA (-)" button several times, then turn and hold the transmitter's steering wheel all the way to one side. Gradually press the "STEERING EPA (+)" button until front wheels have reached their maximum steering capacity. If you hear the steering servo buzzing, press the "STEERING EPA (-)" until the buzzing stops.

The end point adjustments can be multiplexed to adjust CH2 (throttle), CH3 and CH4. For multiplexing instructions, refer to the [Mode Switching] section.

Adjustment range: 0-120%(the default is 100%), the step value is 5%.

STEERING EPA +: Increases servo travel.

STEERING EPA -: Decreases servo travel.

LED Indicator:

- When using the trim keys the G.LED will flash slowly on short presses and quickly on long presses.
- When the end point adjustment value is at its maximum setting, the G.LED will no longer flash with each press of the button.

-MODE SWITCHING-

This function is for reusing the STEERING TRIM and STEERING EPA buttons for different channels. Refer to the [Trims] and [END POINT ADJUSTMENTS (EPA)] sections above to view their effect on the vehicle.

Function settings:

After turning on the transmitter, quickly press the Bind button twice (within 1 second) to cycle through modes 1, 2, 3, and 4. The default setting when powered on is mode 1.

Mode 1: G.LED flashes slowly once, STEERING TRIM adjusts CH1 and STEERING EPA adjusts CH1.

Mode 2: G.LED flashes twice slowly, STEERING TRIM adjusts CH1 and STEERING EPA adjusts CH2.

Mode 3: G.LED flashes three times slowly, STEERING TRIM adjusts CH3 and STEERING EPA adjusts CH3.

Mode 4: G.LED flashes slowly four times, STEERING TRIM adjusts CH4 and STEERING EPA adjusts CH4.

-FAILSAFE-

This function dictates what the receiver will do in the event that it loses signal from the transmitter, this includes servo position, throttle position, etc.

Function settings:

1. Turn on the transmitter and make sure it is connected to the receiver.

2. Hold the control surface at the desired failsafe position.

3. Press and hold the bind button for 3 seconds, the G.LED will flash for 2 seconds, indicating that the settings were saved.

Note: The failsafe function is not set at the factory by default. If no failsafe setting has been set, the receiver will maintain the output of the last signal when the signal is lost. Failsafe is intended as a safety measure during transmitter signal loss and will not work if the receiver loses power.

-BEGINNER MODE-

Beginner mode is designed for the people who are new to the hobby.

In this mode the throttle is limited to 50 percent and the channel range defaults are set to 1250~1500~1750us.

Function settings:

To switch between beginner and normal modes, press and hold the CH3 button while turning the steering wheel completely counterclockwise, as far as it can go. While holding, turn on the transmitter.

Note: By default, the system is set to normal mode. When set to beginner mode, the G.LED will double flash for 3 seconds after turning on the transmitter.

ESC GUIDE



Specs:

Model:	WP-1040-BRUSHED-V4
Cont./Peak Current:	40A / 180A
LIPO/NiMH Cells:	2-3S LIPO / 5-9 Cells NiMH
Applications:	1/10th Vehicles
Motor Limit 2S LiPO / 5-6 Cells NiMH:	540/550 Size Brushed Motor $\geq 12T$
Motor Limit 3S LiPO / 7-9 Cells NiMH:	540/550 Size Brushed Motor $\geq 17T$
Built in BEC:	7.4V @ 5A (Switch-mode)
Size / Weight:	46.5mm x 37.5mm x 27.5mm / 67g

FEATURES:

Waterproof and dust-proof for all weather conditions. (Note: Be sure to clean and dry ESC and connections after wet use to avoid rust.) 2 levels of drag brake: 0% and 100%, allows users to use this ESC for Crawlers or On-Road vehicles.

The ESC includes low-voltage cutoff protection, thermal protection, throttle signal loss protection, and motor lock-up protection. The ESC is easily programmed using the included jumper caps.

PROTECTIVE FEATURES:

Low-voltage Cutoff Protection. When the "Battery Type" is set to "LIPO", the cutoff voltage for each battery cell is 3.2V. When using a 2S LiPo, the cutoff voltage for the pack will be 6.4V. When using a 3S pack the cutoff voltage will be 9.6V. When the "Battery Type" is set to "NiMH", the cutoff voltage (for the pack) is 4.5V. The ESC will cut throttle power output to 1/2 when it detects the pack voltage has dropped to the cut-off threshold for 2 seconds, and completely cut the throttle power output off after 8 seconds. The Red LED will blink repeatedly. Turn off the ESC and remove the discharged battery pack. Wait for the battery to cool before recharging.

Note: Be absolutely sure the "Battery Type" is set properly. If the low-voltage cutoff protection is activated prematurely, and you are certain the battery type is set correctly, the battery being used may not have a high enough discharge rate, or is damaged. Try another fully charged battery pack with a higher discharge rate (be sure ESC is set according to the new battery being used).

Thermal Protection. The ESC will cut off all power output and the Red LED will blink repeatedly when its internal temperature reaches the value (105°C/221°F) preset by the factory. The ESC will return to normal operation when the ESC temperature falls below 80°C/176°F.

Note: If the thermal protection is activated on a regular basis, then there may be an issue with the vehicle's power demands. The motor may be geared too high, the vehicle or load may be too heavy, the drive train may be obstructed or binding, or an improper motor is being used.

Throttle Signal Loss Protection. The ESC will immediately cut power output and the Red LED will blink rapidly when it detects that the throttle signal has been lost for 0.1 second.

WARNING:

To avoid short circuits, ensure that all wires & connections are well insulated and there is good contact at all connections. Read through the entire manual before operating and ensure all electronics are installed correctly. To avoid accidents, we recommend setting the vehicle on a stand, with the tires free from any contact, while connecting and adjusting electronics. Stop usage and unplug the battery immediately if the ESC exceeds 90°C/194°F as this may damage both the ESC and motor. Disconnect the battery after use. The ESC continually draws current from the battery (even if the ESC is turned off). If left plugged in for long periods of time, the battery will completely discharge, which may result in damage to the battery or ESC. This WILL NOT be covered under warranty.

ESC

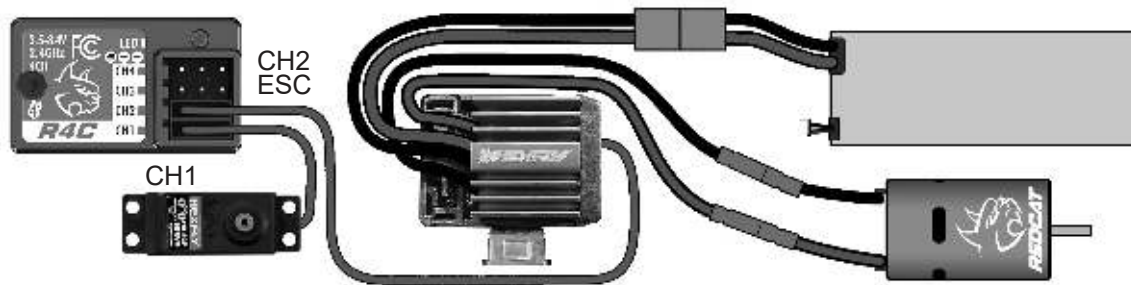

OPERATION:

Step 1: Connect all components (as shown in wiring diagram) and recheck all connections before moving to the next step.

Step 2: Set the Throttle Range. This ESC can automatically recognize the neutral position of the transmitter, but you need to follow the following steps.

1. Turn on the transmitter and move the throttle trigger to the neutral position.
2. With the ESC powered off, connect the motor, battery and other devices.
3. Turn on the ESC and wait at least 3 seconds. The ESC will automatically detect neutral.
Note: The ESC will beep according to the battery type and cell count used. If the ESC is set to use a LIPO battery, the ESC will sound 2 short beeps if it detects a 2S LIPO, and 3 short beeps if it detects a 3S LIPO. If the ESC is set to use a NiMH battery, it will beep one short beep followed by one long beep to indicate self detection is over and the ESC is ready to use.

ATTENTION!

1. After turning on the ESC, you must wait (at least 3 seconds) until the self detection completes. Otherwise, it may not function properly.
2. After turning on the ESC, if there is no power output and the Red LED flashes rapidly, it means the throttle of the transmitter is not in the neutral position. If this happens, be sure the "Throttle Trim" on the transmitter is at the "0" position, fine tune the throttle neutral position until the Red LED stops flashing.
3. To avoid any possible injury, always turn on the transmitter first and the ESC last, and then turn off the ESC first and the transmitter last. Be sure the transmitter is on anytime the vehicle is on.

Step 3: The Red LED will emit certain flash sequences while running the vehicle. If everything is hooked up correctly and the vehicle is running normal, the ESC LED should look like this.

1. The Red LED will turn off when the throttle trigger is in the throttle neutral zone.
2. The Red LED flashes rapidly when the vehicle is lightly throttled forward and turns solid Red when full throttle is used.
3. The Red LED flashes rapidly when the vehicle is lightly throttled rearward and turns solid Red when full reverse or brake is used.

Note: swap the two wires from motor to ESC if you find the motor runs in reverse, but check the Throttle Reverse switch on the transmitter first.

Programming

The first row is "Running Mode".

Insert the jumper into the two left pins on F/B/R to achieve the "Forward/Brake/Reverse" (F/B/R) running mode. In this mode, push the throttle trigger once to brake, release and push the trigger a second time to go reverse.
Note: When "Running Mode" is set to "F/B/R", the reverse force is 50%, and the brake force will be 100% and no drag brake.

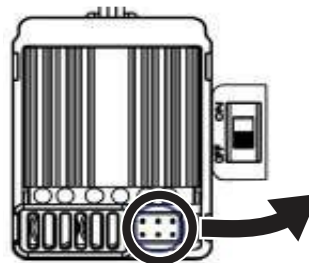

RUNNING MODE	<input type="checkbox"/> ●●●	<input type="checkbox"/> ●●●	<input type="checkbox"/> ●●●
	F/B/R	F/B	F/R
BATTERY	<input type="checkbox"/> ●●●	<input type="checkbox"/> ●●●	
	LiPo	NIMH	

Inserting the jumper into the two right pins on F/B to achieve the "Forward/Brake"(F/B) running mode. It is recognized as a racing mode. In this mode, the vehicle will only go forward and brake.

Note: When "Running Mode" is set to "F/B", the brake force will be 100% and no drag brake.

Without a jumper inserted into any slot on the first row, the running mode will be defaulted as "Forward/Reverse"(F/R). In this mode, there is no brake. The vehicle will go reverse immediately when you push the throttle trigger. Release the trigger to stop. It is usually used for crawlers.

Note: When "Running Mode" is set to "F/R", the reverse force will be 100%, and the drag brake force will be activated to 100%.

The second row is "Battery Type".

Insert the other jumper into the two left pins on the LiPo slot when using a Li-Po battery, and insert the other jumper into the two right pins on the NiMH slot when using a Ni-Mh battery. When no jumper insertion into the second row, the battery type will be defaulted as "LiPo".

TROUBLESHOOTING

TROUBLE	POSSIBLE CAUSE	POSSIBLE SOLUTIONS
NiMH battery charge doesn't last as long as it should	<ol style="list-style-type: none"> 1. ESC is set to LiPo battery 2. NiMH battery is not charged completely 3. NiMH battery is not holding a charge 	<ol style="list-style-type: none"> 1. Refer to the ESC Guide to set the ESC jumper to NiMH battery 2, 3. Completely charge the NiMH battery with an appropriate NiMH charger.
LiPo battery won't recharge after running the vehicle	<ol style="list-style-type: none"> 1. ESC is set to NiMH battery and the LiPo battery was discharged below the safe level. 2. Bad LiPo battery 	<ol style="list-style-type: none"> 1. Refer to the ESC Guide and set the ESC jumper to LiPo battery. Properly dispose of the LiPo battery, as it is no longer safe to use 2. Replace the LiPo battery with a fully charged, brand new battery. Dispose of the bad battery in accordance to your local laws.
The ESC will not power on and the ON/OFF switch was turned ON.	<ol style="list-style-type: none"> 1. No power is being supplied to the ESC. 2. The ESC switch may be damaged. 	<ol style="list-style-type: none"> 1. Check if all ESC & connections are well soldered and firmly connected. 2. Contact Redcat support.
The vehicle ran backward when you pulled the throttle trigger towards you.	<ol style="list-style-type: none"> 1. The radio "Throttle Reverse" switch may be improperly set. 2. The motor-to-ESC wiring is incorrect. 	<ol style="list-style-type: none"> 1. Switch the radio "Throttle Reverse" switch. 2. Swap the two wires (black and red) from the motor to the ESC.
Vehicle moves with no throttle input	<ol style="list-style-type: none"> 1. Throttle trim is not set properly 2. Did not follow proper start-up instructions 	<ol style="list-style-type: none"> 1. Set transmitter throttle trim 2. Follow the proper start-up sequence
The motor suddenly stopped working, but the steering still works.	The LVC protection or the thermal protection may have been activated.	Check the battery voltage and the ESC temperature. Let cool and recharge battery
The motor accelerated suddenly, stuttered or stopped during the starting-up process.	<ol style="list-style-type: none"> 1. The discharge capacity of the pack is insufficient. 2. The RPM is too high, the gear ratio or final drive ratio is incorrect. 3. Gear mesh too tight. 	<ol style="list-style-type: none"> 1. Use another pack with better discharge capability. 2. Use stock motor, stock gearing, and don't pull heavy loads. 3. Reset gear mesh.
The motor spins but the car doesn't move	Incorrect slipper adjustment	Tighten slipper clutch until vehicle moves. Slipper should still slip when vehicle is held still on carpet and given 25% throttle. See Slipper Clutch Guide Page: 16
Grinding sound	<ol style="list-style-type: none"> 1. Gear mesh too loose 2. Gears worn 	<ol style="list-style-type: none"> 1. Reset gear mesh 2. Replace gears
Clicking noise while steering	<ol style="list-style-type: none"> 1. Servo gears stripped 2. Servo horn stripped 	<ol style="list-style-type: none"> 1. Replace servo 2. Replace servo horn
Vehicle won't steer or move	<ol style="list-style-type: none"> 1. Battery pack not charged 2. Battery wires loose 3. Did not follow proper start-up instructions 	<ol style="list-style-type: none"> 1. Charge battery pack 2. Plug in battery securely 3. Follow Quick Start Guide for proper start-up sequence
Vehicle turns to the side automatically	<ol style="list-style-type: none"> 1. Steering trim needs adjusting 2. Steering servo horn needs realigning or replaced 3. Servo gears stripped 4. Too much toe-out in front wheels 	<ol style="list-style-type: none"> 1. Adjust transmitter steering trim 2. Check servo horn, replace if worn or stripped 3. Replace servo 4. Adjust steering linkage to lessen toe amount
Vehicle steers to the left when you steer to the right	<ol style="list-style-type: none"> 1. Steering reverse switch (on transmitter) is set incorrectly 2. You are driving towards yourself and it just seems like it's backwards 	<ol style="list-style-type: none"> 1. Flip the steering reverse switch (on transmitter) 2. Practice driving the vehicle to get used to steering with different vehicle orientations. When driving towards yourself, it just seems like the steering is backwards

CHANGING THE UNDERDRIVE GEARS - EVEREST ASCENT & ASCENT FUSION

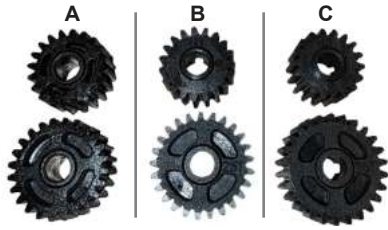

Gearing Options:

- A: 0% Underdrive - 20T upper and 24T lower. (NO markings on gears)
- B: 10% Underdrive (9.2% Actual) - 19T upper 25T lower. (Gears are marked)
- C: 20% Underdrive (18.49% Actual) - 18T upper 26T lower. (Gears are marked)

ATTENTION: You must use one of the combinations shown above. Other combinations will not work due to fitment and gearmesh issues.

Stock Gearing: Everest Ascent - 0% Underdrive
Ascent Fusion - 20% Underdrive

1. Unbolt the top of one of the rear shocks.



2. Unbolt rear driveshaft from the transfercase.



3. Remove driveshaft from the transfer case.

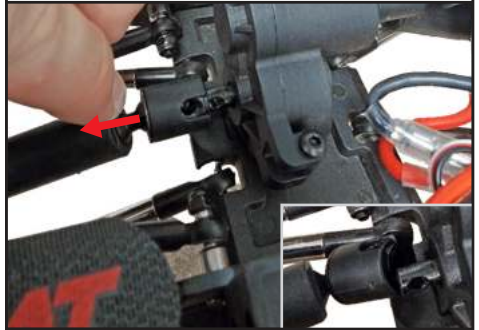

4. Unscrew the 2 screws on the top of the transfer case.

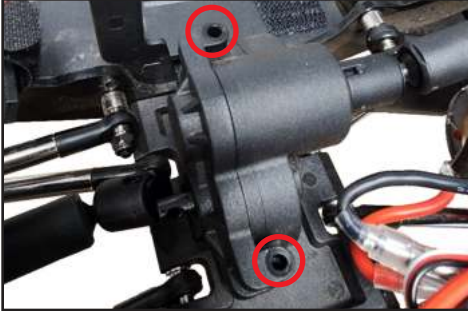

5. Pull the rear cover off of the transfer case.



6. Angle the front of the chassis down and pull the upper gear out of transfer case. (Angling the chassis helps to keep the gear pin from falling out of the idler shaft.)

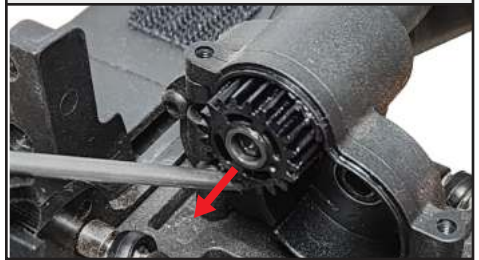

This is what it should look like.



7. Push the lower idler shaft out of rear case.

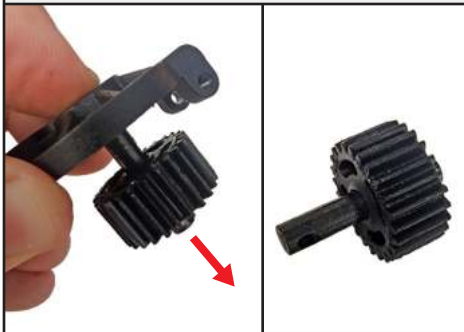

8. Pull the gear off of the lower idler shaft.

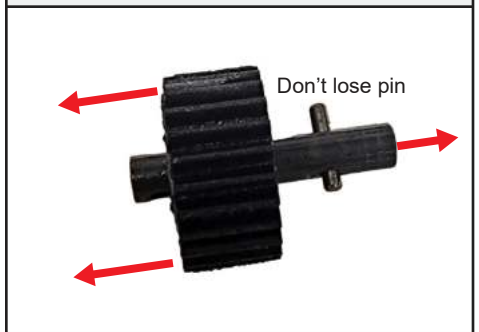

9. Choose an underdrive gear set:
0% - 20T upper / 24T lower. (no markings)
10% (9.2% Actual) - 19T upper / 25T lower.
20% (18.49% Actual) - 18T upper / 26T lower.

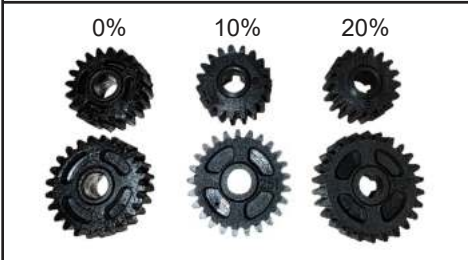

10. Put the new lower gear on lower idler shaft. (Will be either 24T, 25T, or 26T depending on your choice) (see step 9)

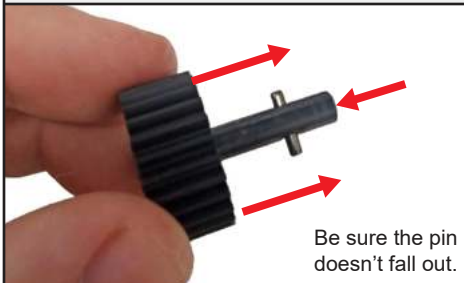

11. Put the lower idler shaft into the rear case.

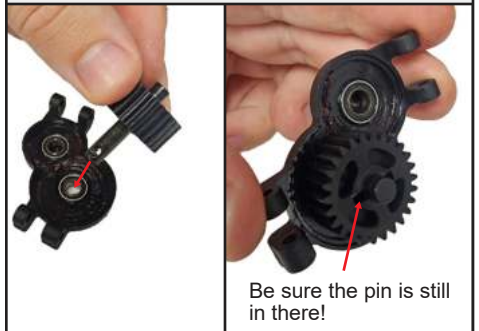

CHANGING THE UNDERDRIVE GEARS - EVEREST ASCENT & ASCENT FUSION

12. Slide the new upper gear onto the upper idler shaft. (Will be either 20T, 19T, or 18T depending on choice) (18T is pictured)



13. Realign the rear case and gently push it into place. (you may need to rotate the idler shaft slightly to line up the gears)



14. Reinstall the two screws. The longer screw goes into the driver's side of the case and the shorter screw goes into the passenger's side.

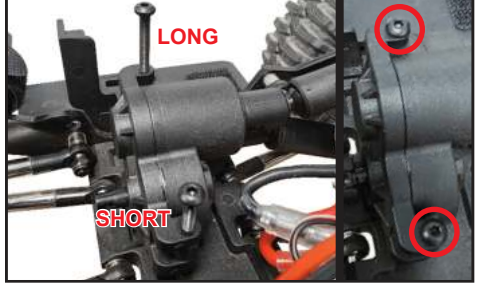

15. Reattach the driveshaft and reinstall the driveshaft screw.

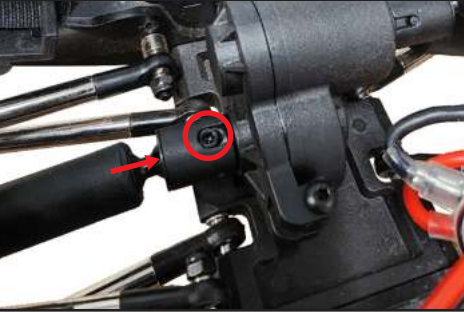

















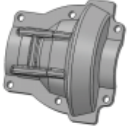



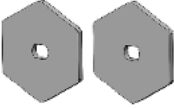
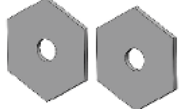











16. Reconnect the rear shock.



























SPARE PARTS

RER22039-F/R Bumper Set w/Mounts(Stand)(1Set) 	RER22040-F/R Bumper Set w/Mounts(Dovetail)(1Set) 	RER22041-Body Post Set (1Set) 	RER22042-Servo Mount Set (1Set) 	RER22043-Battery Tray Set (1Set)
RER22138-Side Plates(1pr) 	RER22139-Shock Towers (Rear)(1pc) 	RER22140-Center Skid Plate(1pc) 	RER22653 Center Transfer Case Complete w/ Skid(1pc) 	RER22141-Fr Body Mount Hinge Set (1set)
RER22142-Motor Plate Mounts(1set) 	RER22143-Transmission Housing set(1set) 	RER22144- Body Joint Washers(1set) 	RER22145-56T Spur Gear (32P)(1pc) 	RER22240-Transfer Case Gear (20T)(2pcs)
RER22241-Transfer Case Gear (24T)(2pcs) 	RER22242-Transfer Case Gear Option Set (18T/19T/25T/26T)(1set) 	RER22243-Front Center Driveshaft(29mm)(1set) 	RER22244-Rear Center Driveshaft(37mm)(1set) 	RER22245 Transfer Case Driveshaft Set(1set)
RER22246 F/R Shock Absorbers(2pcs) 	RER22247-Frame Rail Set (2pcs) 	RER22248-Motor Plate (1pc) 	RER22249-Shock Towers (1pr) 	
RER22341-MT-9 Mud Terrain 1.9 Tires (Soft)(1pr) 	RER22342-1.9 Crawler Wheel (White)(2pcs) 	RER22343-Pre-Mounted MT-9 Mud Terrain 1.9 Crawler Tires (1pr) 	RER22344-12T Pinion Gear (32P)(1pc) 3*3	RER22345-Transfer Case Shaft for 25T Gear(1pc)
RER22442-Transfer Case Shaft for 24T Gear (2pcs) 	RER22346-Top Shaft for 56T Gear(1pc) 	RER22347-Front Upper Links(64.5mm)(2PCS) 	RER22348-Rear Upper Links(94mm)(2PCS) 	RER22349-Front Lower Links(83mm)(2PCS)

SPARE PARTS

<p>RER22350-Rear Lower Links(96mm)(2PCS)</p> 	<p>RER22357-Servo Link (44.5mm)(1pc)</p> 	<p>RER15431-Lower Link Mounts(1set)</p> 	<p>RER15432-Portal Center Gearbox Housing(2pcs)</p> 	<p>RER15429-Front Portal Housing Set (1set)</p> 
<p>RER11816-Rear Outer Portal Housing Set (L/R)</p> 	<p>RER11347-Portal Axle Spool (1pc)</p> 	<p>RER11346-Differential Cover (1pc)</p> 	<p>RER11362-Portal Axle Ring Gear(32T)(2PCS)</p> 	<p>RER11363-Portal Axle Pinion Gear(11T)(2pcs)</p> 
<p>RER11364-Portal Axle Output Gear(17T)(2pcs)</p> 	<p>RER11365-Rear Portal Axle Input Gear(8T)(2pcs)</p> 	<p>RER11356-Metal Slipper Plate(2pcs)</p> 	<p>RER11357-Slipper Pads(2pcs)</p> 	<p>RER15450-Steering Link(96mm)(1pc)</p> 
<p>RER22552-Panhard Bar (84.5mm)(1pc)</p> 	<p>RER11349-Rear Portal Axle Shafts</p> 	<p>RER15439-Front Portal Universal Shafts(1pr)</p> 	<p>RER11420-Shaft for 17T Gear (2pcs)</p> 	<p>RER11421-Shaft for 11T Gear (2pcs)</p> 
<p>RER21669-Universal Axle Rebuild Kit (1set)</p> 	<p>RER11371-4x8x3mm Rubber Sealed Ball Bearings(6pcs)</p> 	<p>RER11370-6x10x3mm Rubber Sealed Ball Bearings(2pcs)</p> 	<p>RER11373-10x5x4mm Rubber Sealed Ball Bearings(6pcs)</p> 	<p>RER11368-6x12x4mm Rubber Sealed Ball Bearings(6pcs)</p> 
<p>RER11369-7x11x3mm Rubber Sealed Ball Bearings(2pcs)</p> 	<p>RER11372-15x10x4mm Rubber Sealed Ball Bearings(6pcs)</p> 	<p>RER11367- 12x18x4mm Rubber Sealed Ball Bearings(2pcs)</p> 	<p>82045-3x8mm Button Head Hex Machine Thread Screws (10pcs)</p> 	<p>50100-3x10mm Button Head Hex Machine Thread Screws (8pcs)</p> 
<p>50101-3x12mm Button Head Hex Machine Thread Screws (12pcs)</p> 	<p>14582-3x14mm Button Head Hex Machine Thread Screws (10pcs)</p> 	<p>RER11376-3x16mm Button Head Hex Screw (10pcs)</p> 	<p>82047-3x20mm Button Head Hex Machine Thread Screws (8pcs)</p> 	<p>70548-3x22mm Button Head Hex Machine Thread Screws (8pcs)</p> 

SPARE PARTS

<p>70581-3x23mm Button Head Hex Machine Thread Screws (8pcs)</p> 	<p>13854-3x28mm Button Head Hex Machine Thread Screws (8pcs)</p> 	<p>BS702-036 3x35mm Shoulder Button Head Hex Machine Thread Screws (12pcs)</p> 	<p>RER11377-3x43mm Shoulder Button Head Hex Machine Thread Screws (10pcs)</p> 	<p>RER11378-2x6mm Cap Head Hex Machine Thread Screw (10pcs)</p> 
<p>RER11380-2x10mm Cap Head Screw (10pcs)</p> 	<p>RER11381-2x14mm Cap Head Screw (10pcs)</p> 	<p>RER11382-2x8mm Countersunk Hex Machine Thread Screws(10pcs)</p> 	<p>85825-3x10mm Countersunk Hex Machine Thread Screws(4pcs)</p> 	<p>14577-3x12mm Countersunk Hex Machine Thread Screws(10pcs)</p> 
<p>02098-M3x3Grub Hex. Screw (8pcs)</p> 	<p>13840-3x18mm Hex Screw (8pcs)</p> 	<p>RER15452-4x11.5mm Hex Screw Pin(10pcs)</p> 	<p>RER11384-King Pin Bushing(8pcs)</p> 	<p>70544- Ball Head Of Front Shock (5MM)</p> 
<p>18052-Short Rod End Ball (5.8mm)(8pcs)</p> 	<p>70625-Ball Stand ϕ5.9 (Long) (6pcs)</p> 	<p>180016S-12mm Wheel Hex & Pin Set</p> 	<p>08027-Pin 2x10mm</p> 	<p>116201-2x10.8mm Pin (10pcs)</p> 
<p>02102-3mm Lock Nuts (6pcs)</p> 	<p>RER12694-4mm Flanged Lock Nuts (8pcs)</p> 	<p>RER13469- R-Clip</p> 	<p>RER11426-Shim 4.2x8x0.4(10pcs)</p> 	<p>RER11374-2x4mm Button Head Hex Machine Thread Screws (10pcs)</p> 

SPARE BODY PARTS

RER22351 -10th Crawler Dovetail Body(Clear)(1pc)
RER22352 -10th Crawler Dovetail Body(Blue)(1pc)

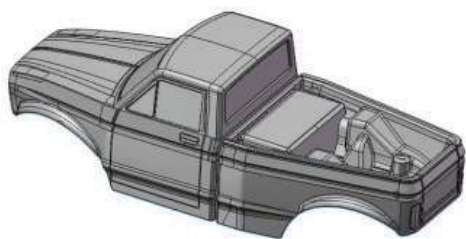

RER22353 -10th Crawler Body(Clear)(1pc)
RER22354 -10th Crawler Body(Red)(1pc)

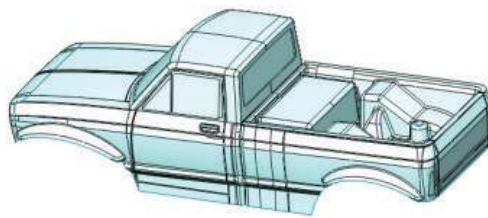

ELECTRONICS

RER22355 -HX-1040 Brushed ESC V4(Deans)(1pc)



RER22356 -550 Brushed Motor w/ 14mm long shaft (42 Turn)(1pc)



Length:14mm

RER12089-Servo Arm (metal)



RER11385-Battery Straps (250mm)(2pcs)



RER16244-HEXFLY Torque Spec Metal Gear Servo (Waterproof)(1pc)



RECOMMENDED

Gens Ace 3S1P 11.1V 3600mAh 60C LiPo Battery(Soft Case)(XT60/Deans)(1pc)



GA-360060C

Hexfly C6D Mini LiPo/NiMH Charger (1pc)



HX-C6D-Mini

Hexfly HX-403 Dual Port 2S-4S AC/DC LiPo LiFe Charger



HX-403

Hexfly Pro X2 Dual Port 1-6S LiPo, 1-15 Cell NiMH/NiCd Charger



RER15247

SHOCKS AND FRONT AXLE EXPLODED VIEW

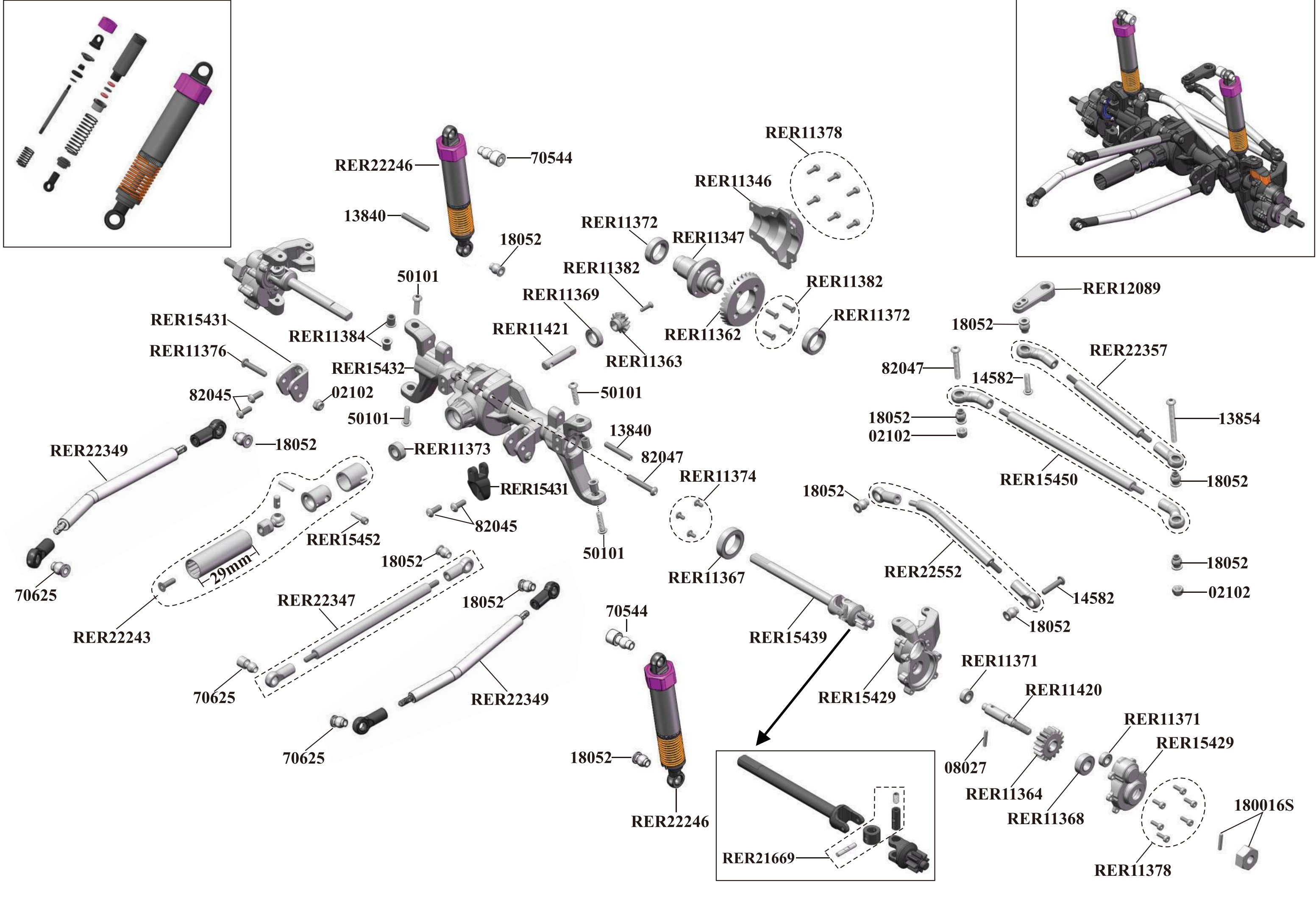

REAR AXLE ASSEMBLY EXPLODED VIEW

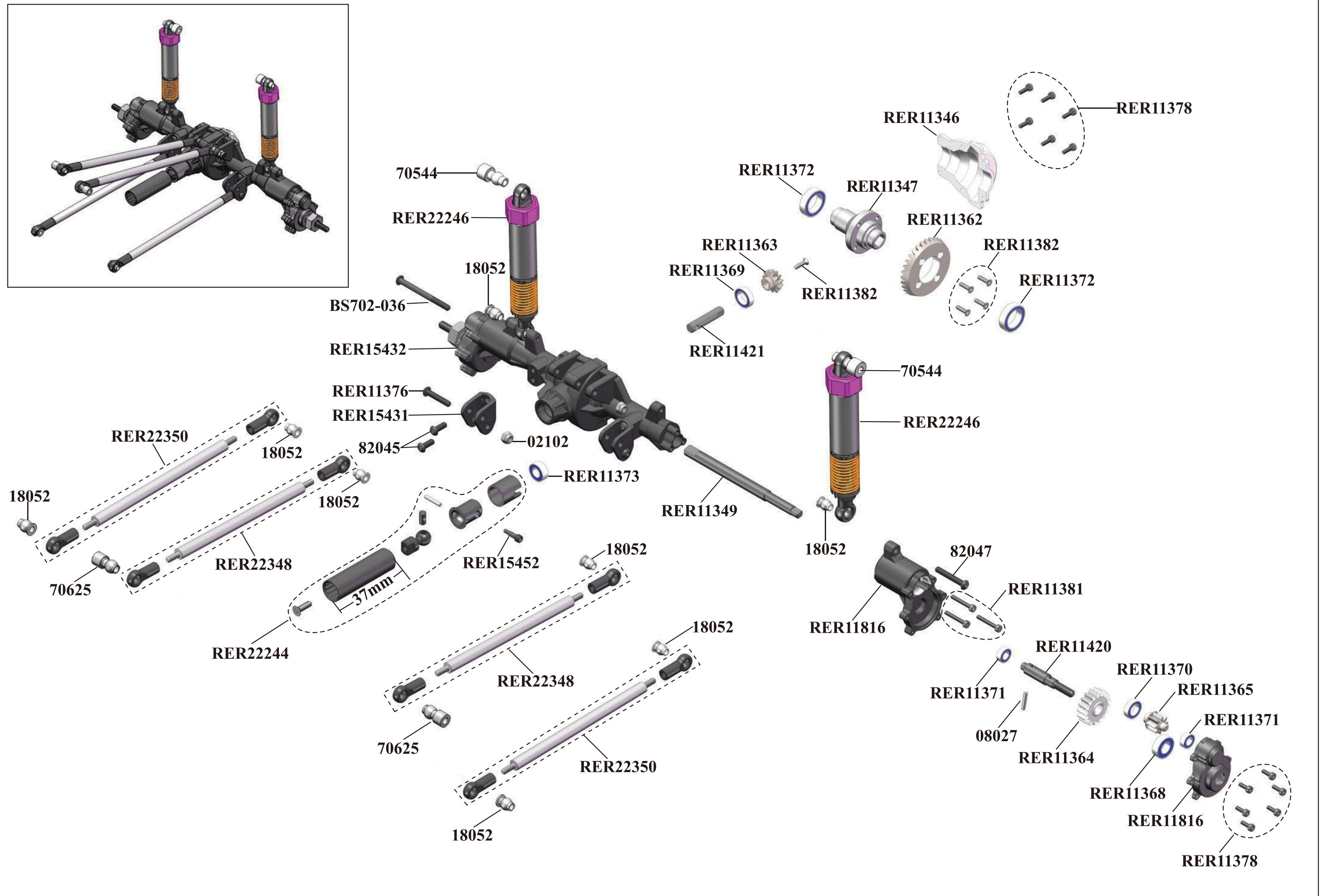

CHASSIS ASSEMBLY EXPLODED VIEWS

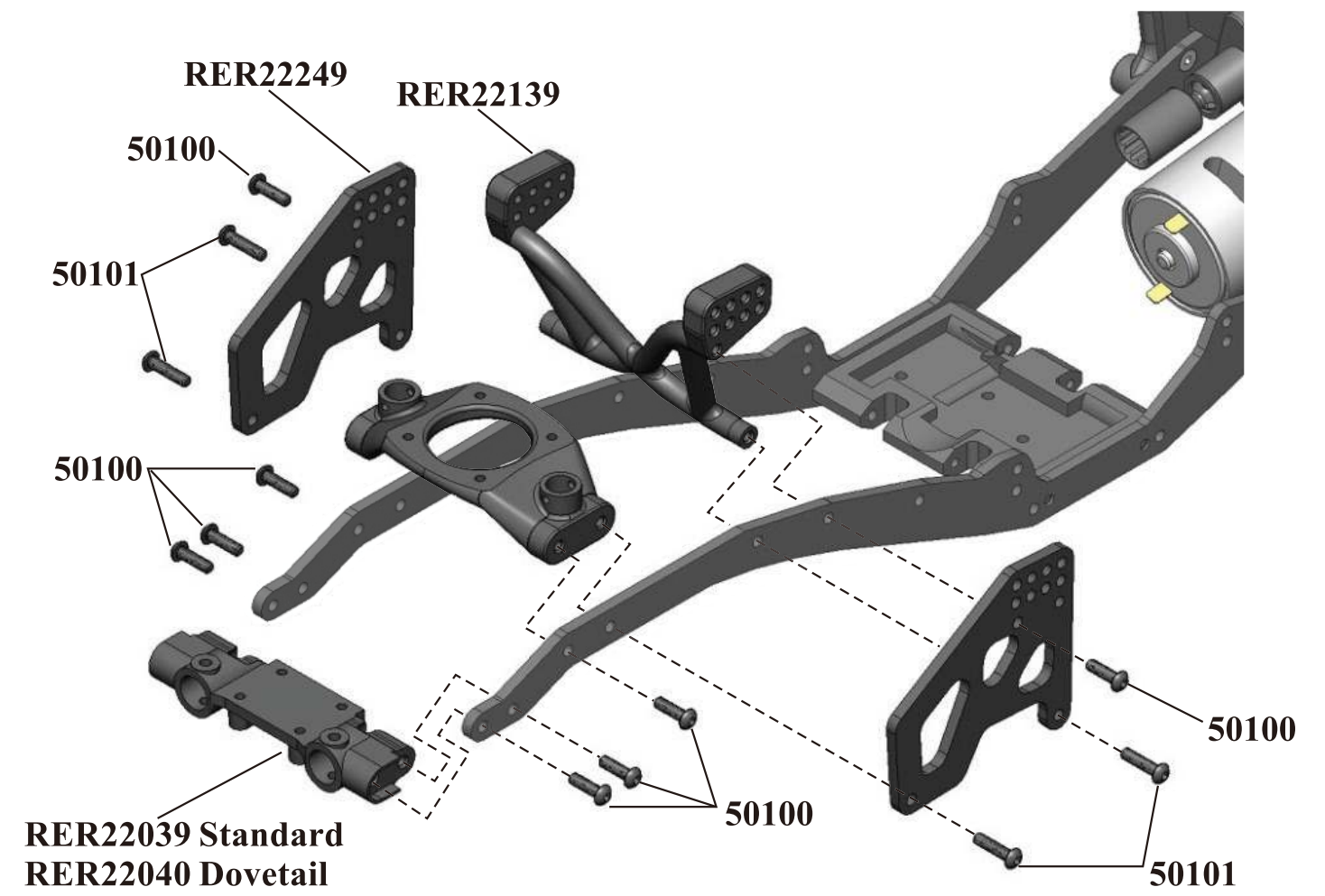
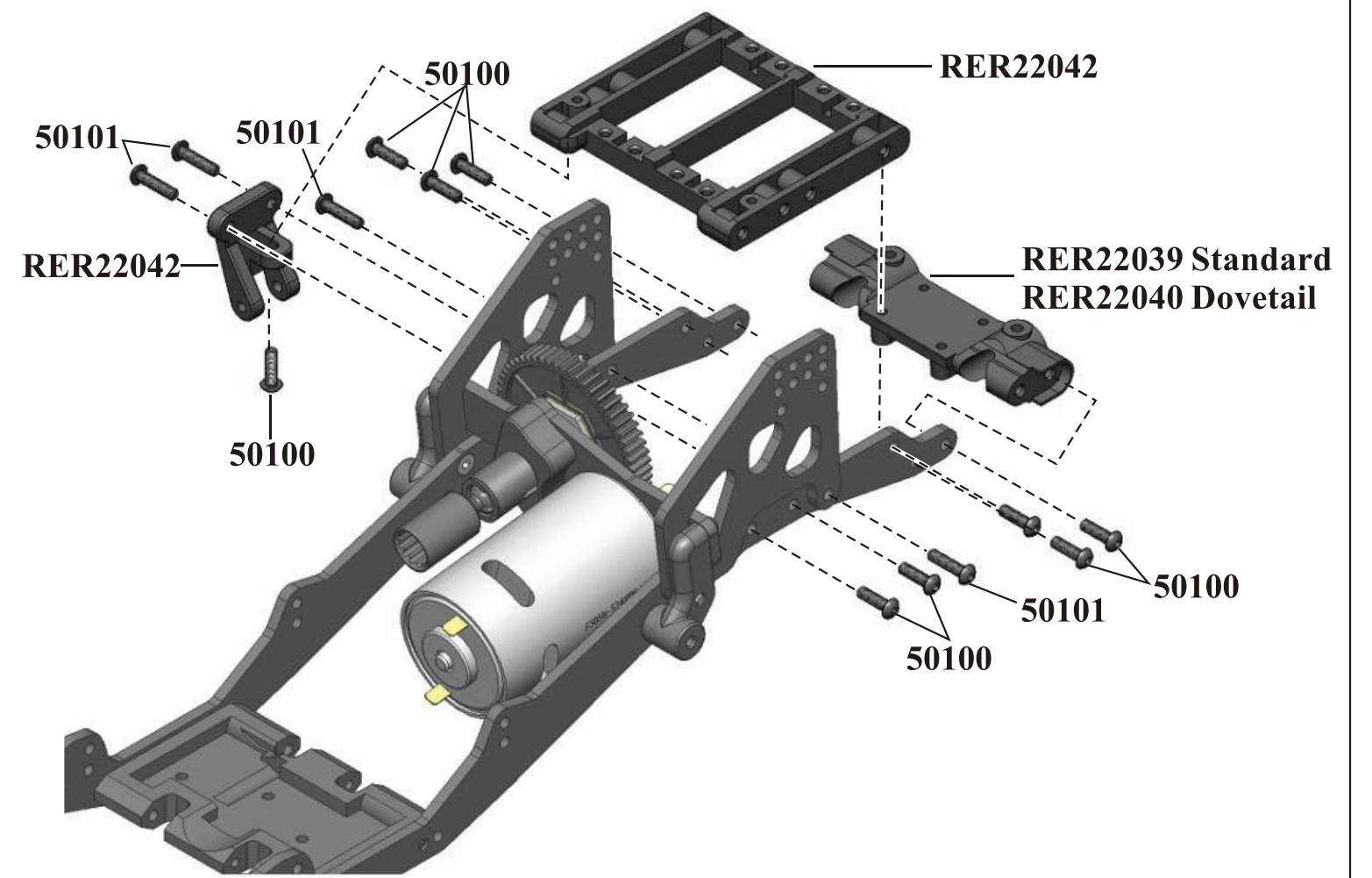
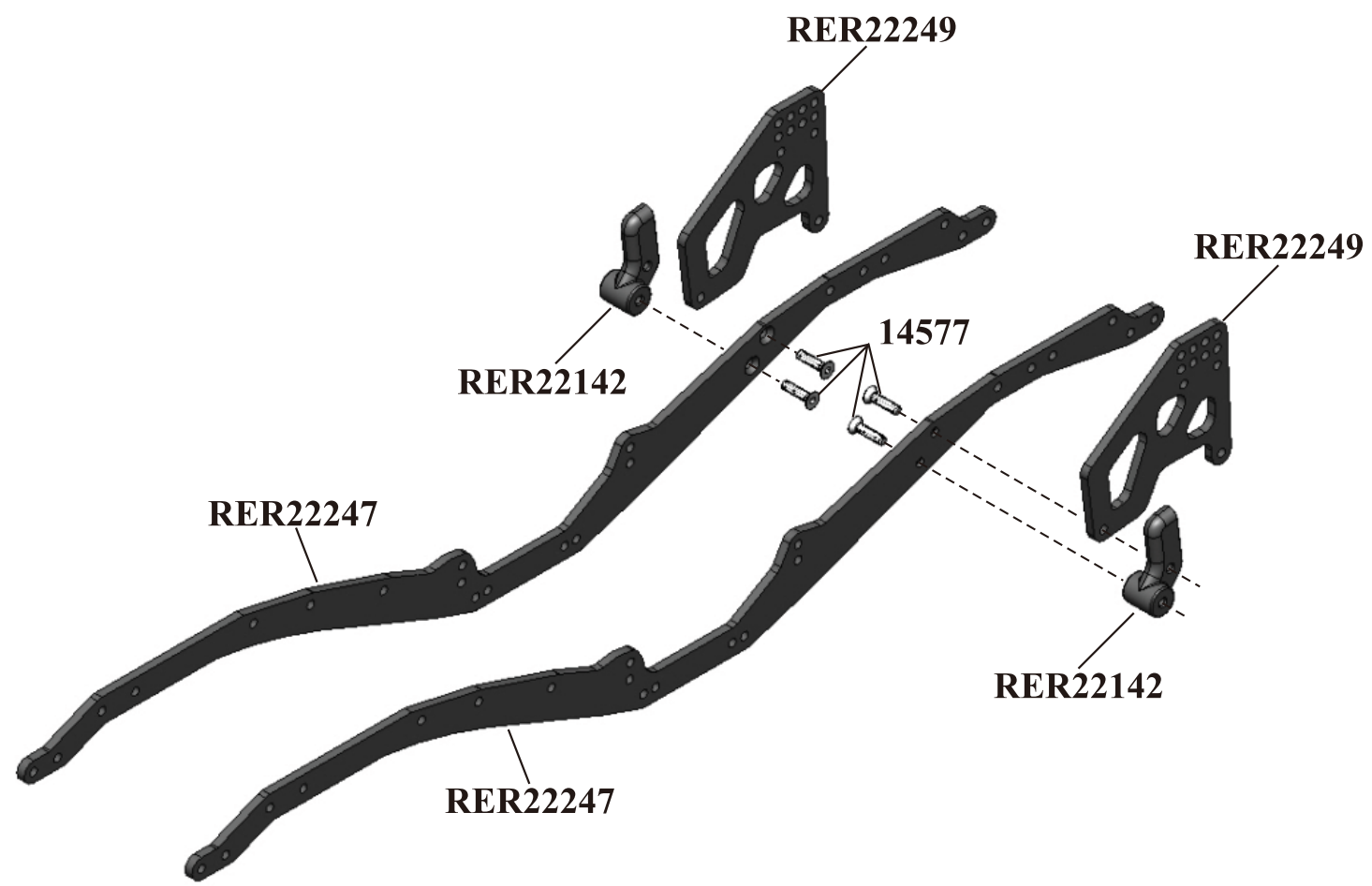

CHASSIS ASSEMBLY EXPLODED VIEWS

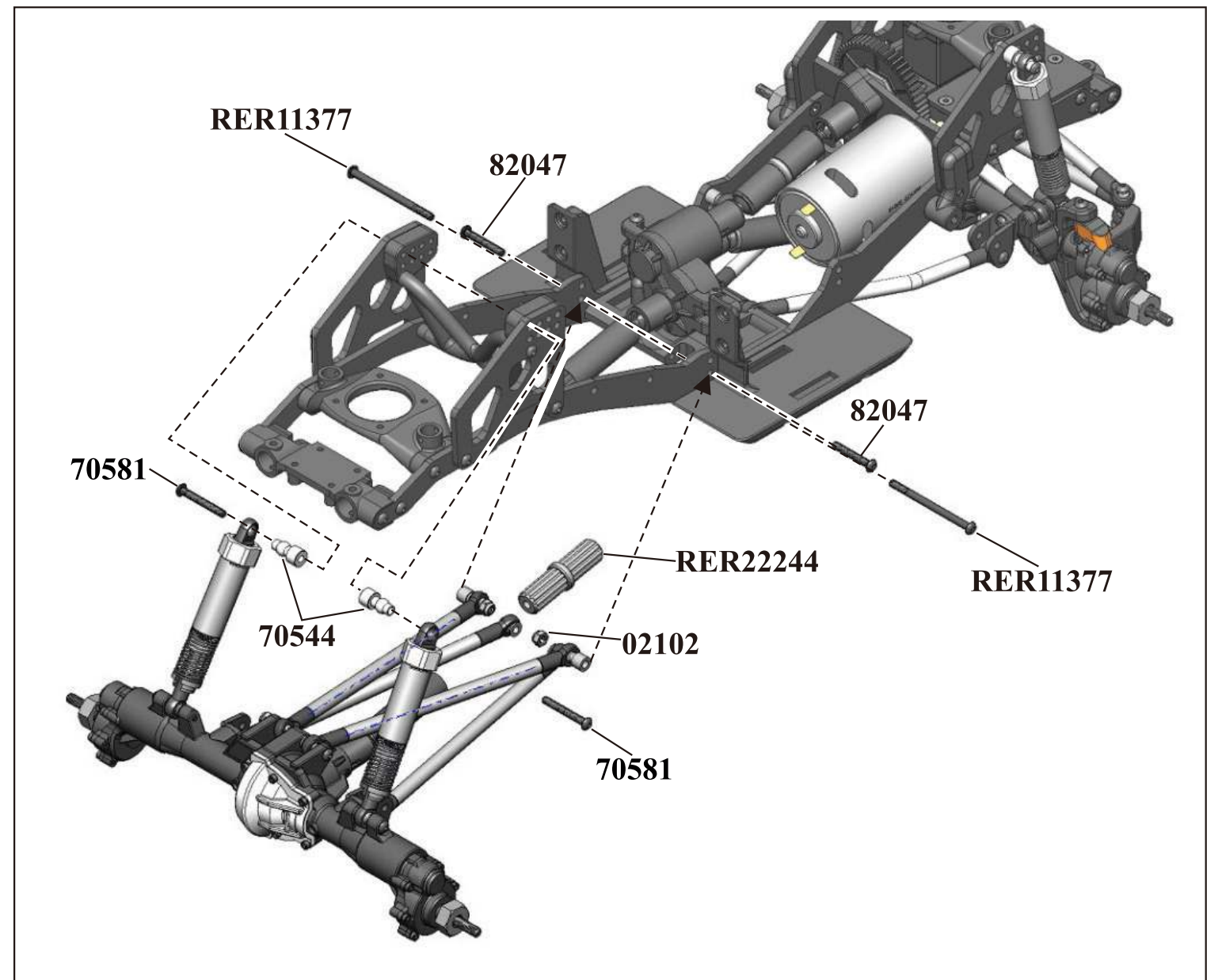
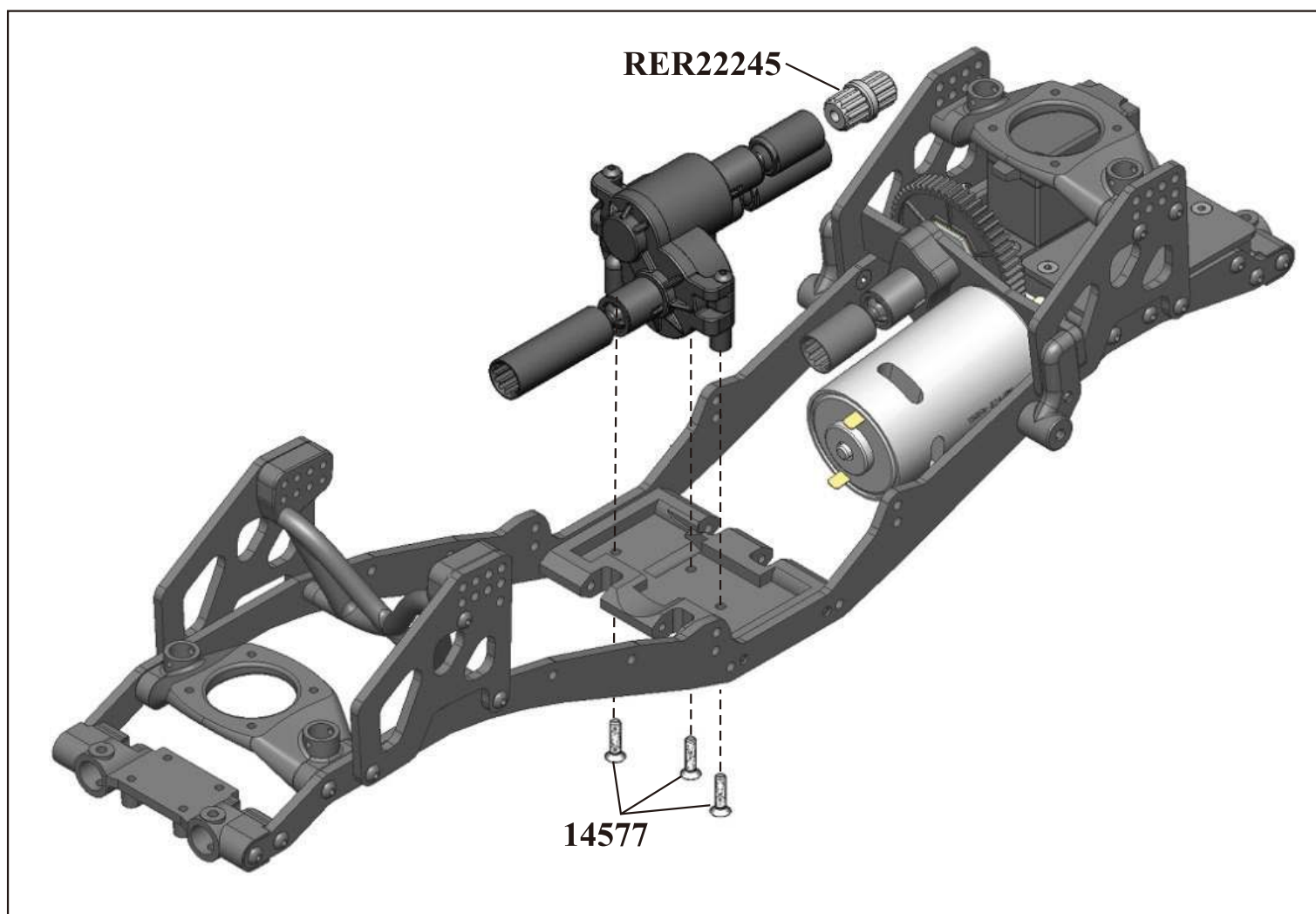
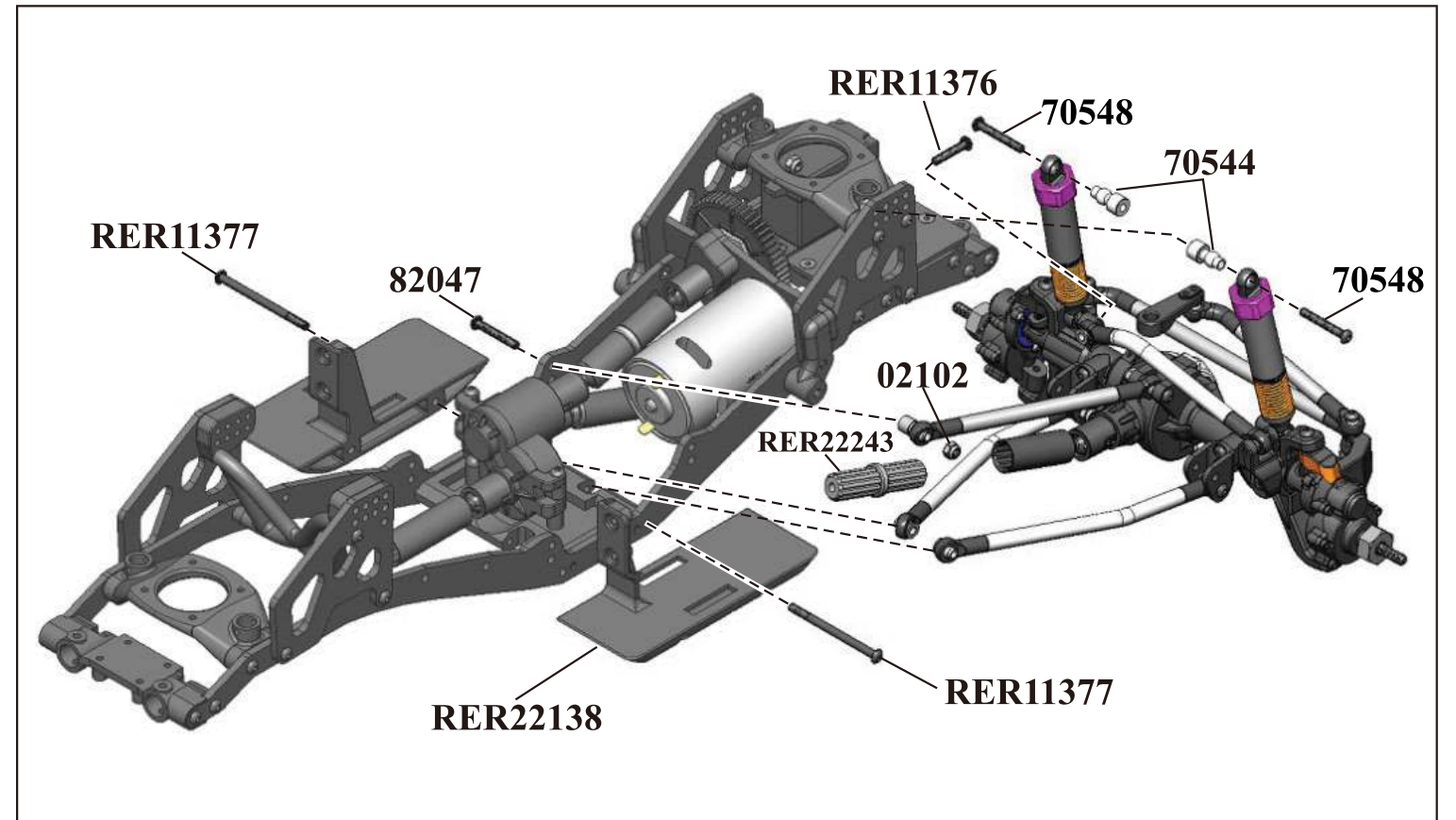
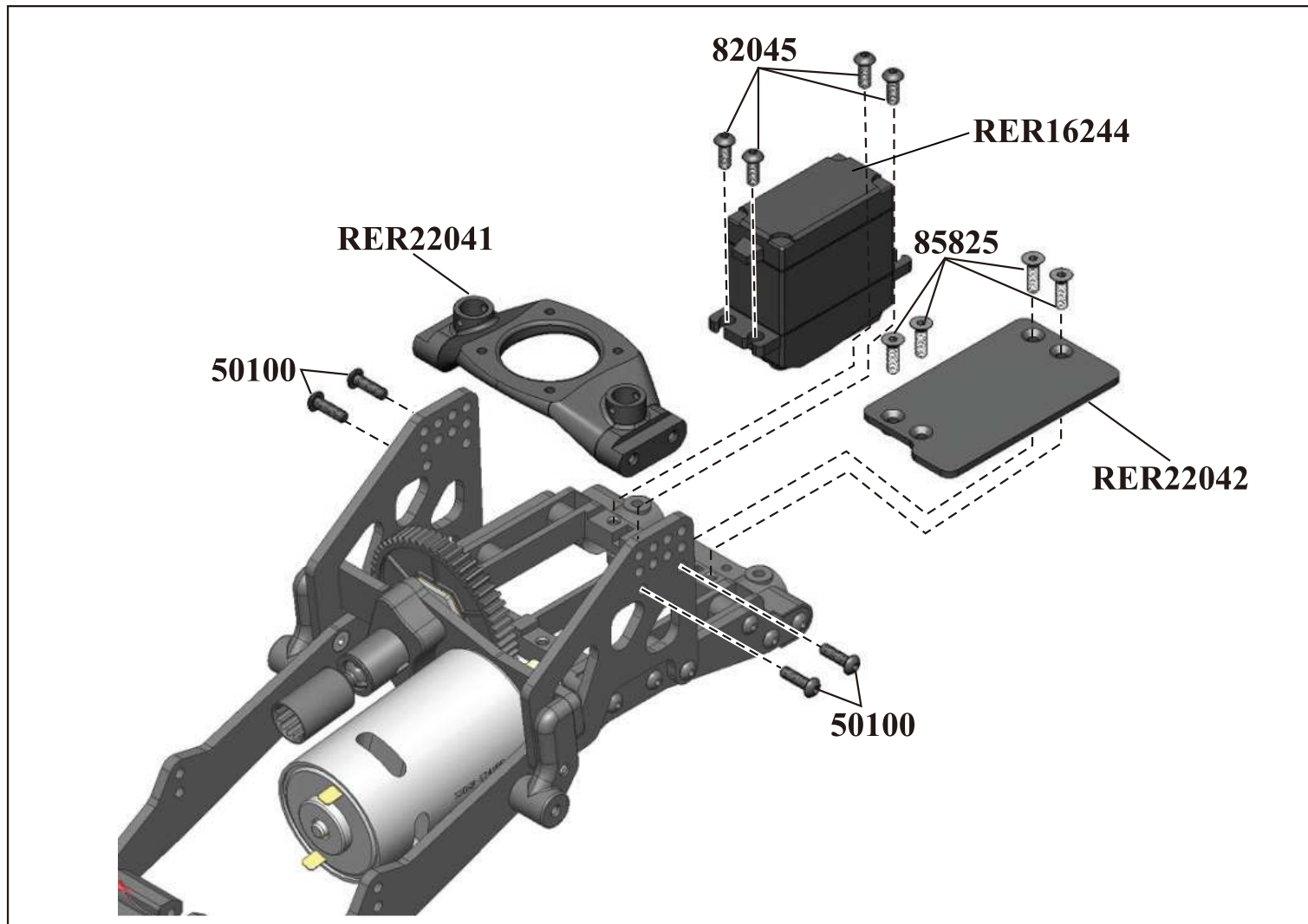

WHEEL AND CHASSIS ASSEMBLY EXPLODED VIEWS

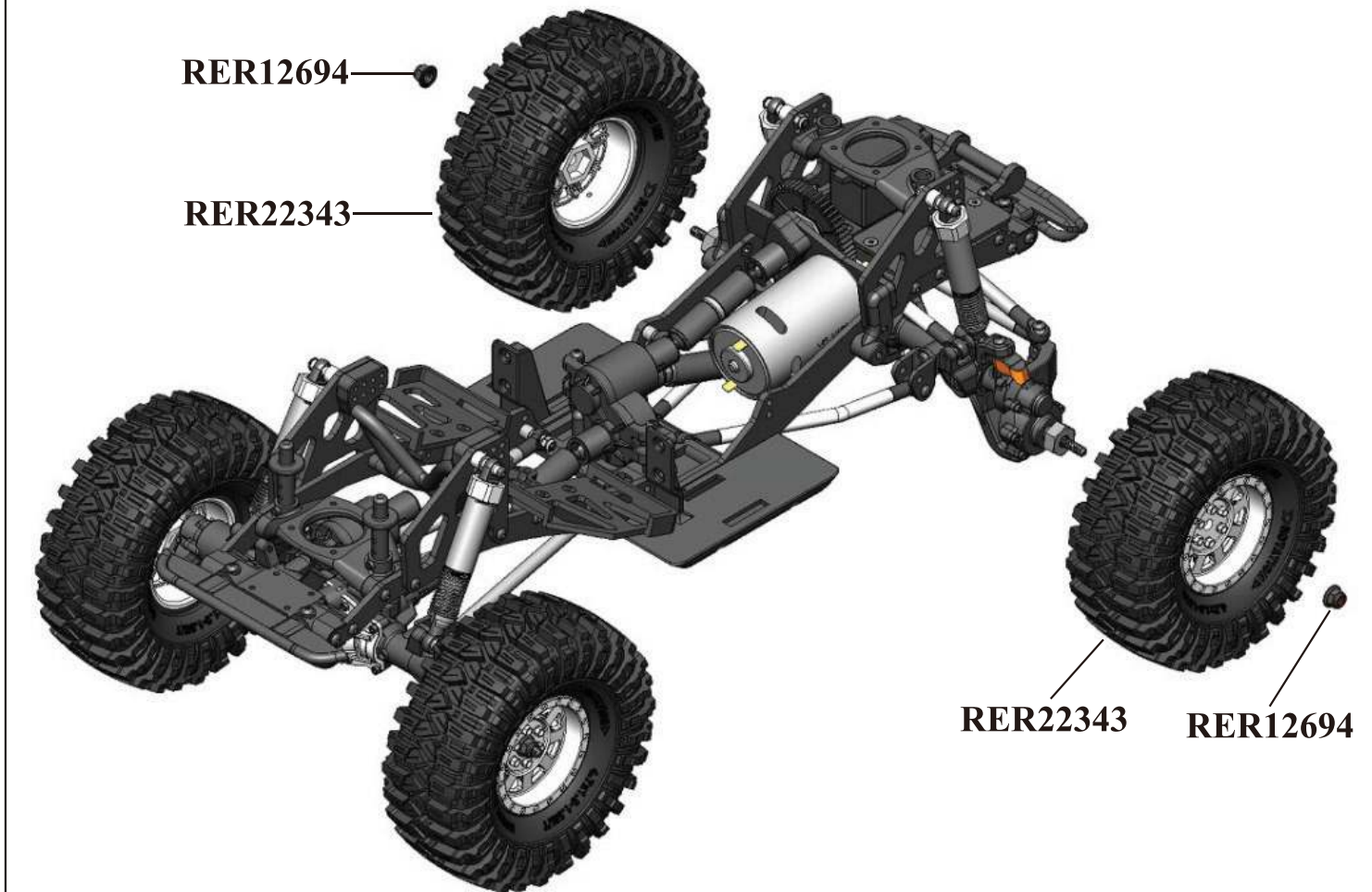
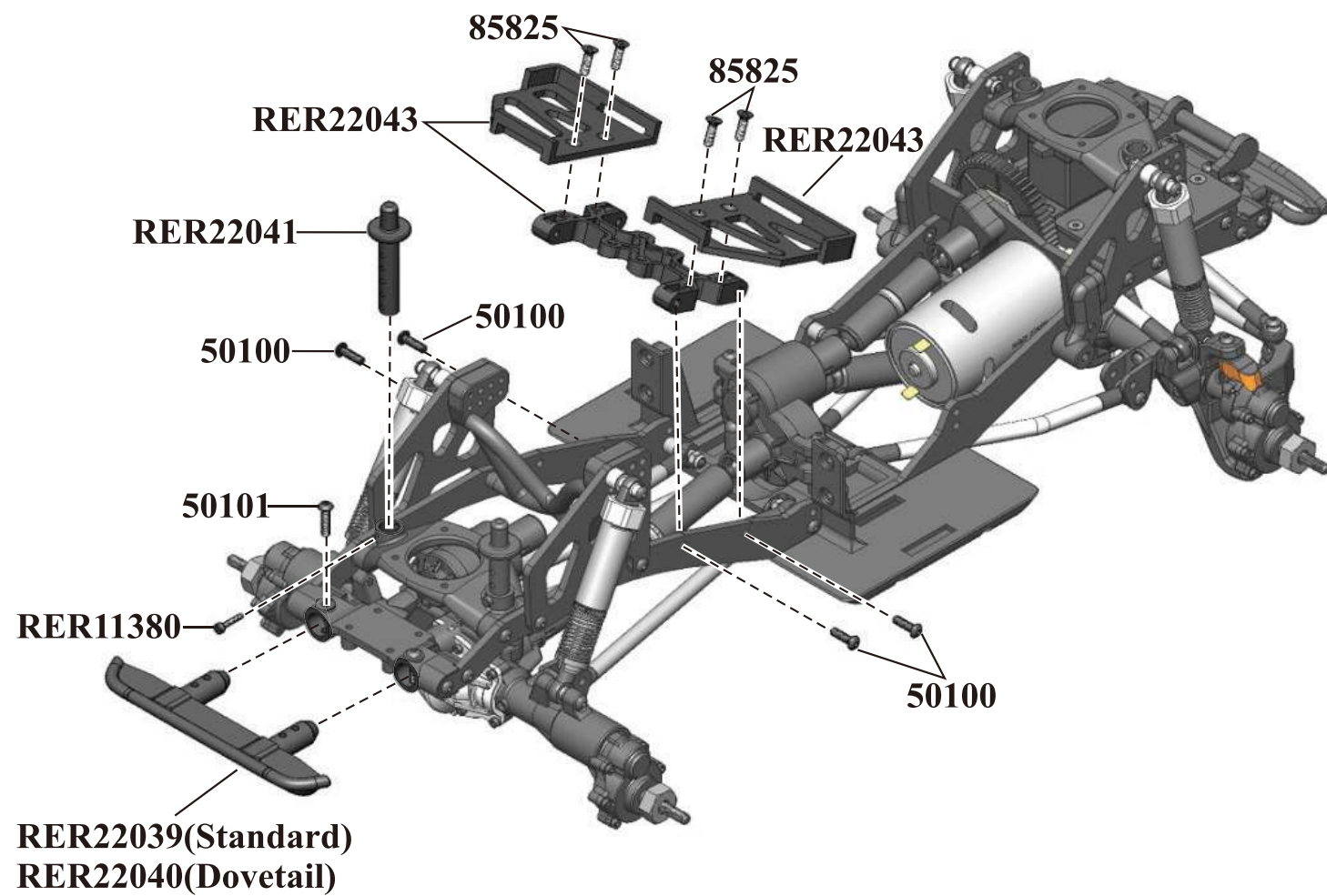
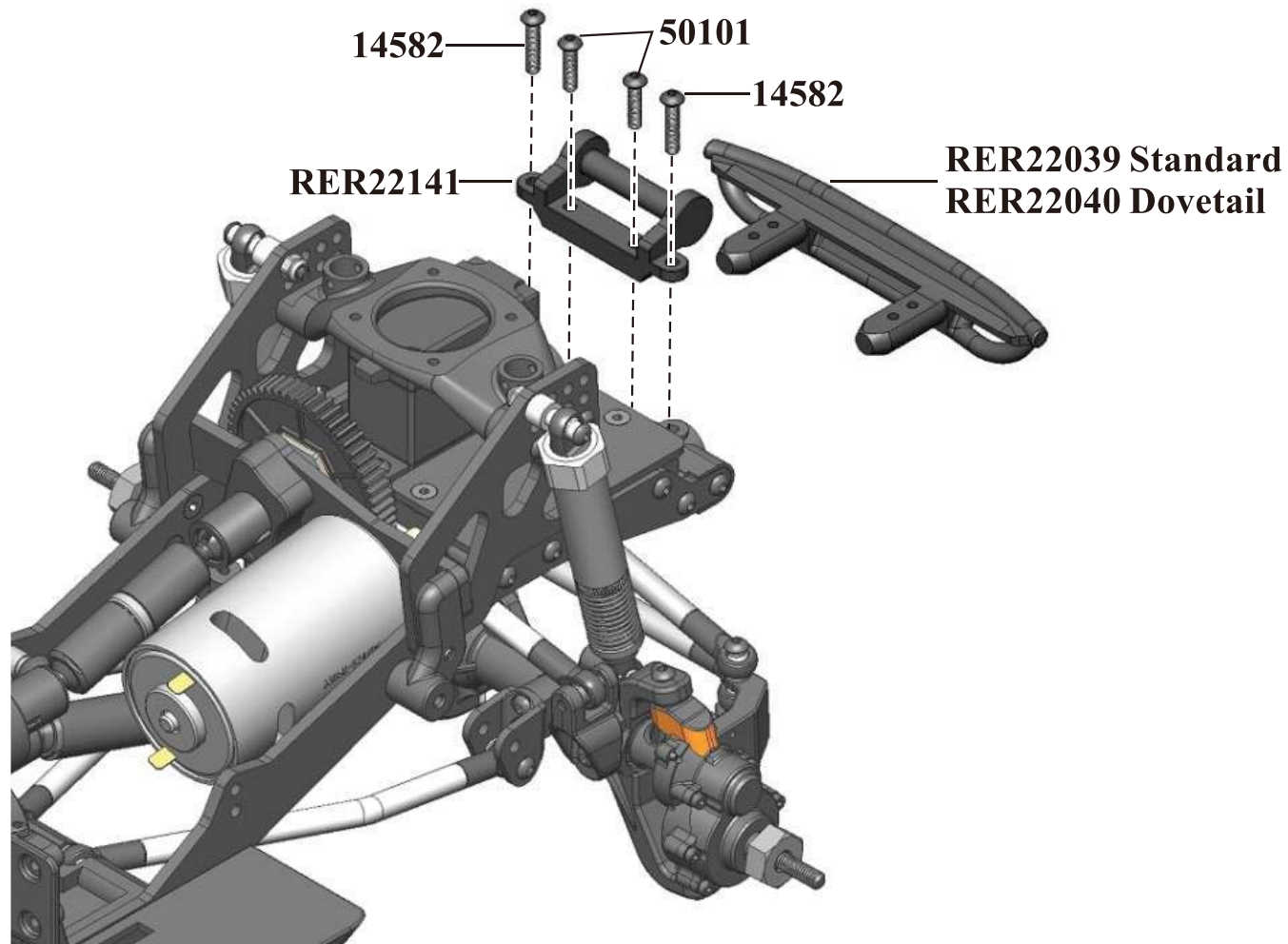

BODY ASSEMBLY AND CHASSIS EXPLODED VIEWS

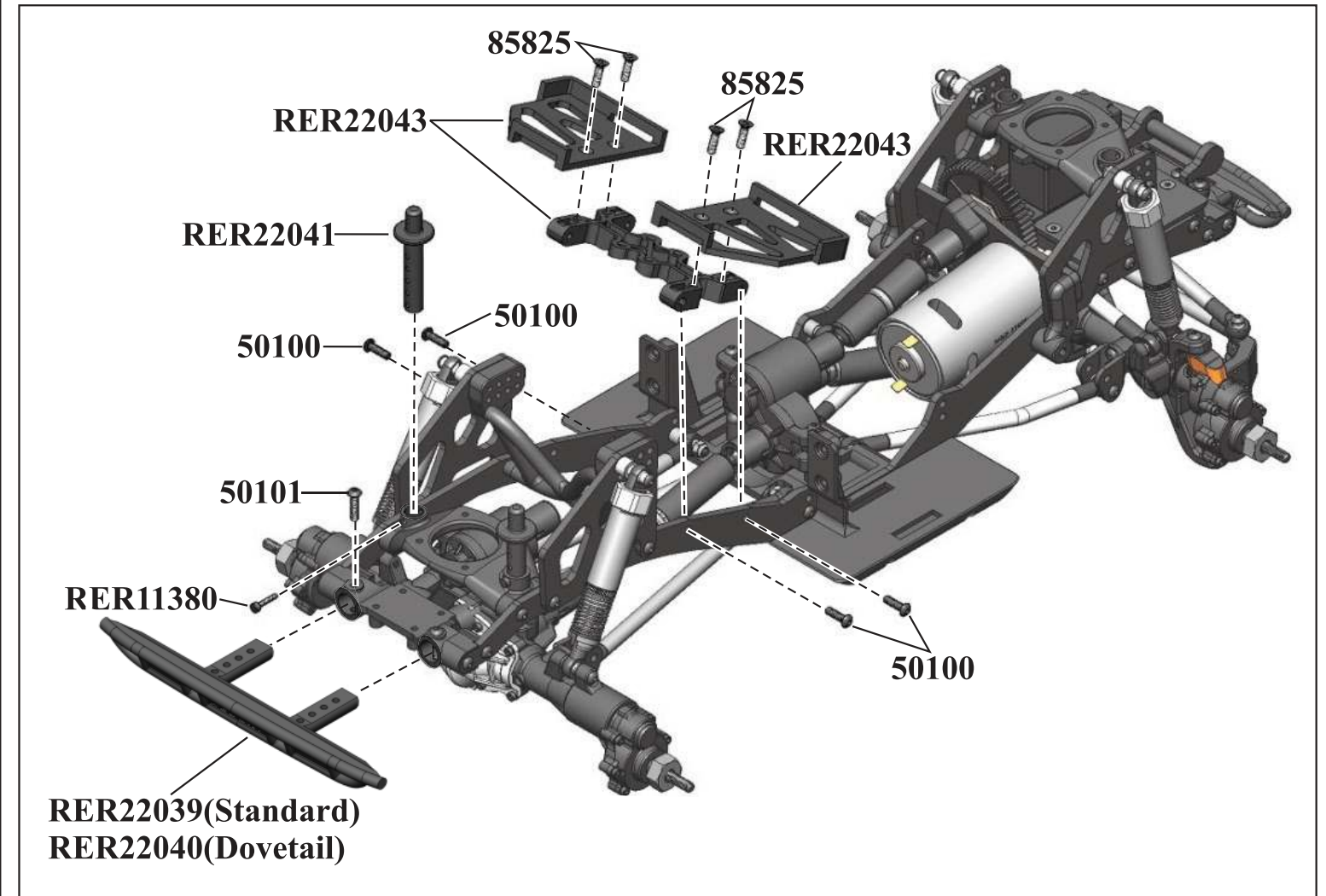
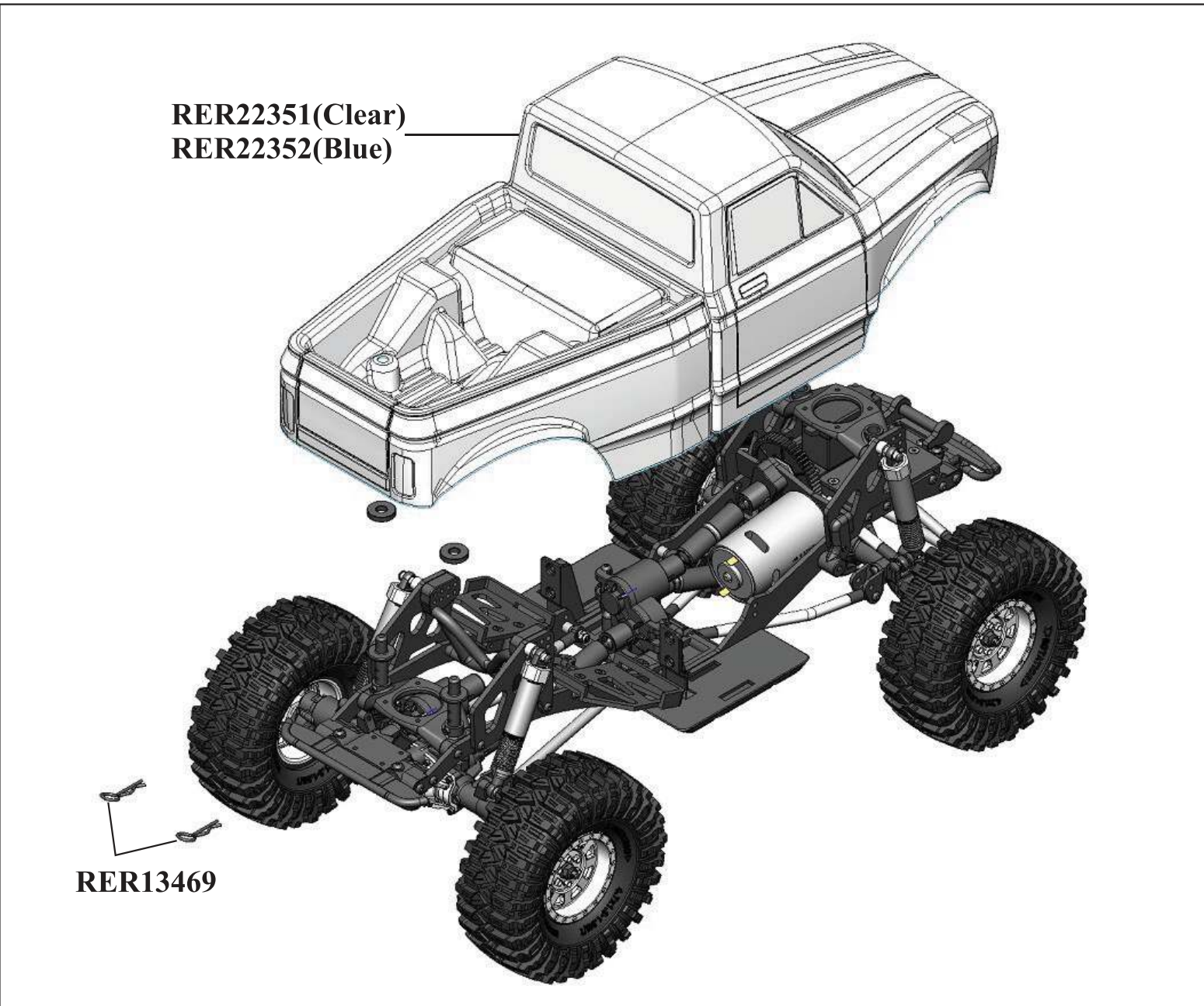
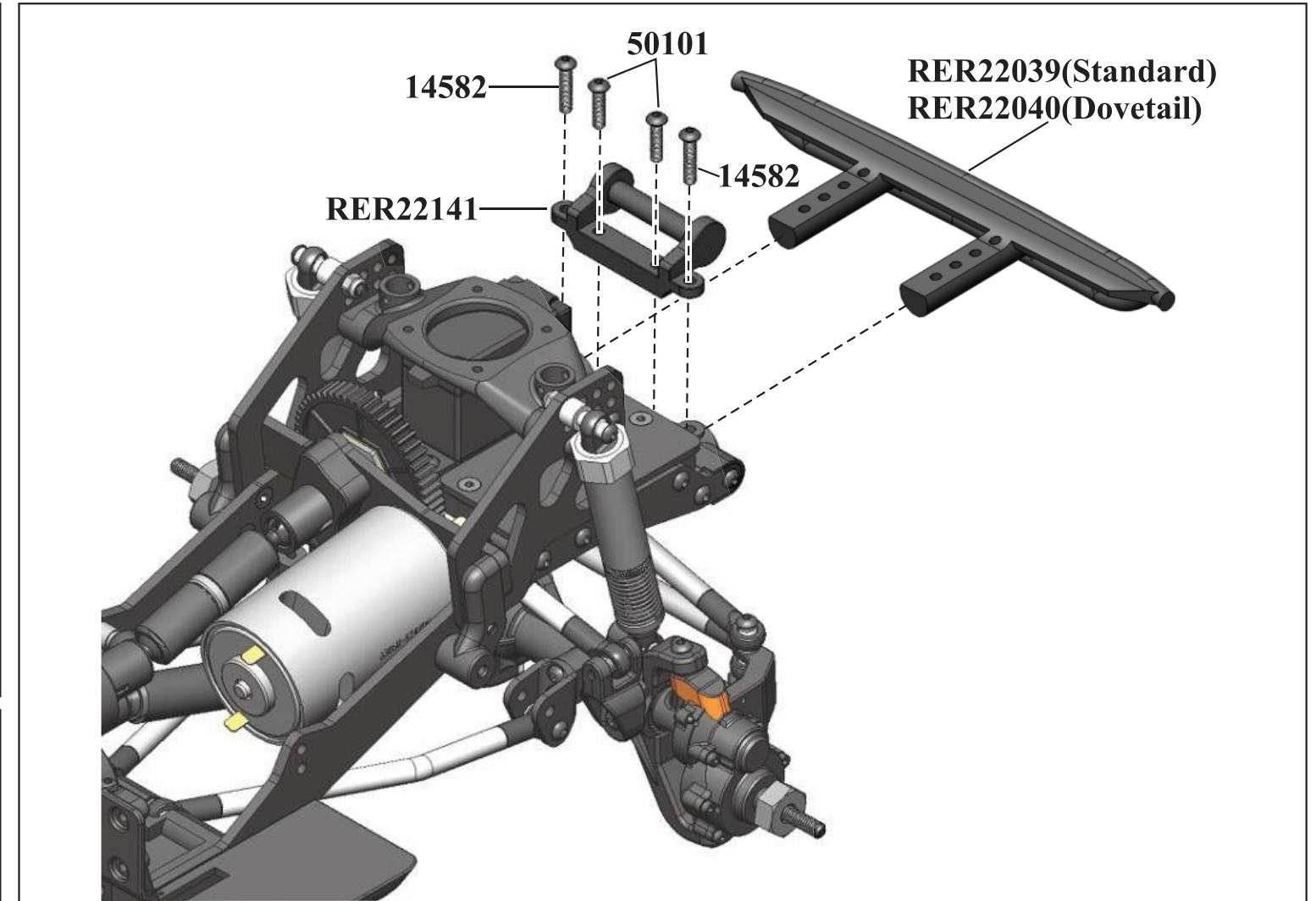
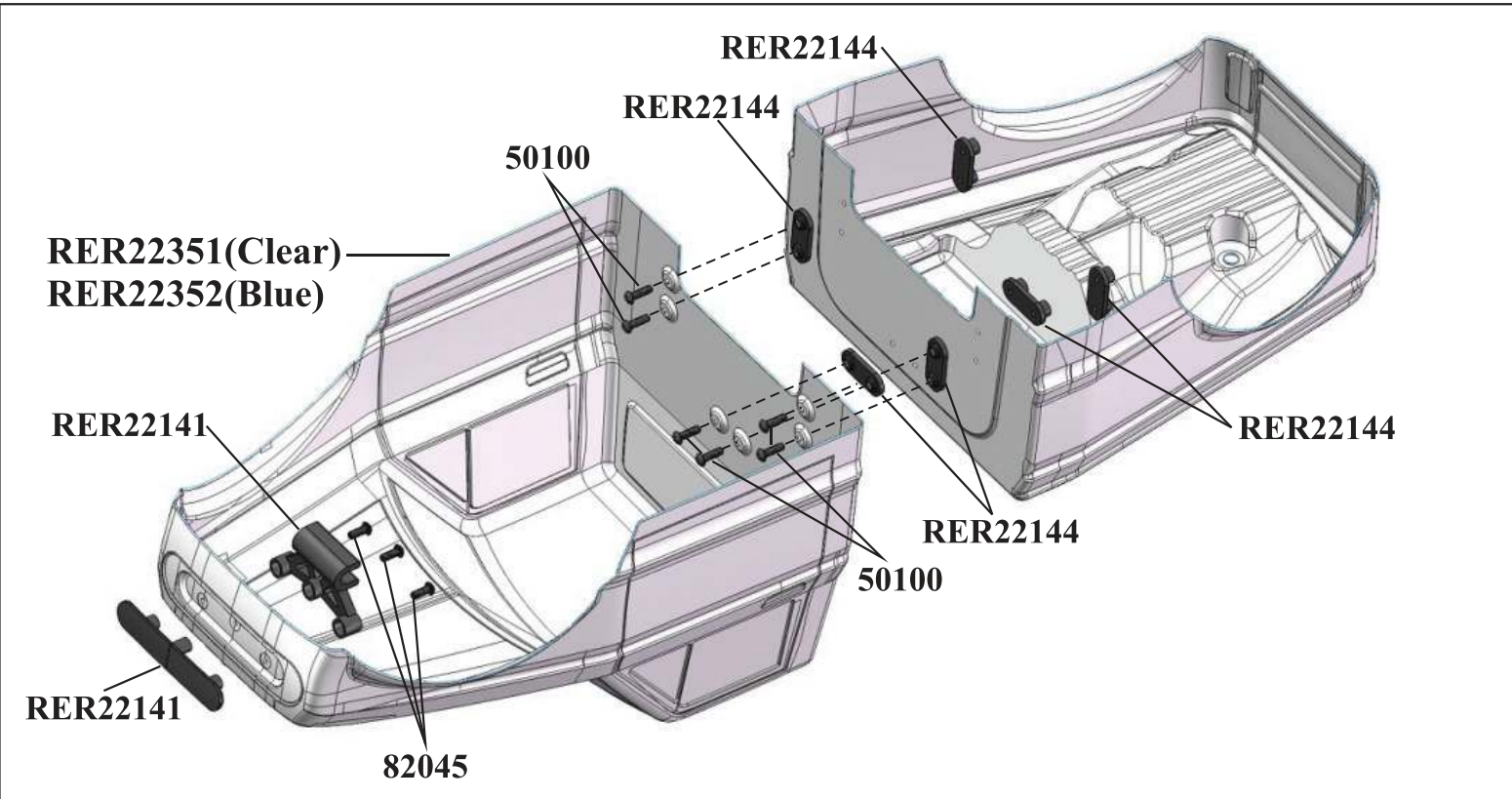

BODY ASSEMBLY EXPLODED VIEW

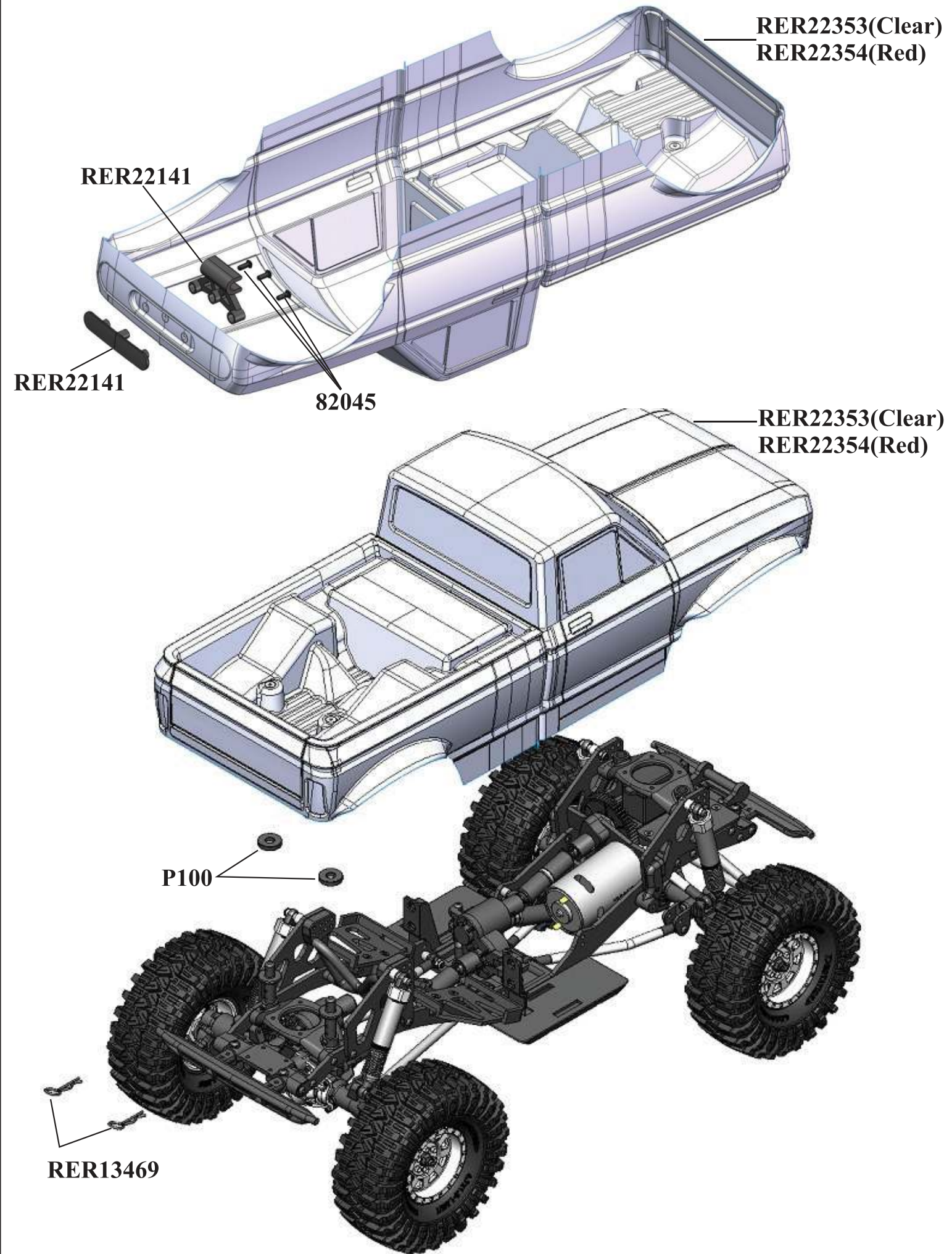



www.redcatracing.com

Follow us on social media

Take a photo, create a video, post and share your Redcat experience.

Stay up to date on the latest Redcat news, products, and creative content. While these profiles are not customer service channels, you might find that one of our subject experts or another member of the community is able to assist you. If you have an issue or need technical and or product support, please reach out to Redcat directly through our website.

-  <https://www.facebook.com/RedcatRacing>
-  <https://www.instagram.com/redcatracing/>
-  <https://www.youtube.com/RedcatRacing>
-  <https://twitter.com/RedcatRacing>
-  <https://www.pinterest.com/redcatracing/>
-  <https://www.tiktok.com/@redcatracing>

IMPORTANT LINKS:

- To view the full length manual with ESC guide, Radio guide, exploded views and parts lists, go to: www.redcatracing.com/pages/manuals
- Link to electric vehicles manual:
www.redcatracing.com/manuals/ELECTRIC-MANUAL.pdf

