



***REDCAT***



**Gas**  
**vehicles**  
INSTRUCTION MANUAL

**[www.redcatracing.com](http://www.redcatracing.com)**

MAN-GAS-2020.06.11.V14

To ensure that you are using the most recent version of this manual:  
[www.redcatracing.com/manuals/GAS-MANUAL.pdf](http://www.redcatracing.com/manuals/GAS-MANUAL.pdf)

# WARNING!

READ ALL INSTRUCTIONS INCLUDED WITH VEHICLE BEFORE OPERATING

**AGE WARNING!**

This radio controlled (RC) vehicle is not a toy! You must be 14 years of age or older to operate this vehicle. Adult supervision is required.

**RISK OF RUNAWAY VEHICLE OR INJURY!**

Never start the engine without first having the controller and receiver turned on, and having tested the controls to make sure everything is functioning properly.

**RISK OF FIRE! / RISK OF EXPLOSION!**

There is a risk of fire and explosion when dealing with gasoline. Gasoline is highly flammable and combustible. Injury or death can occur if proper care is not taken. Follow all precautions that go along with handling gasoline and never allow gas to be near open sparks or flames of any kind. Only use gas rated containers. Gas ignites quickly and emits fumes into the air. The entire area around the gas may have combustible fumes in the air.



This means the air around the gas can flash ignite causing an explosion. Only use outdoors in a well ventilated area.

**POISONOUS!**

Gasoline is toxic. Injury or death can occur if swallowed. May irritate skin and cause injury if absorbed into the skin. Injury or death can occur from breathing the toxic fumes. The exhaust emitted from this Radio Control (RC) vehicle's muffler is toxic and can cause injury or death if inhaled. **KEEP AWAY FROM CHILDREN AND PETS!** Never start the engine indoors, not even in a closed garage. Always follow the appropriate gasoline safe handling practices.

**RISK OF BURNS!**

The engine, exhaust pipe, and other areas of the vehicle get hot. Burns can occur if they are touched after vehicle operation. Allow adequate time to cool before handling.

**RISK OF INJURY!**

Hobby grade RC vehicles can cause serious injury or death if not operated correctly. Never use this vehicle in crowds. Never chase people or animals. Drive in safe open areas only. Keep body parts away from moving parts.

**RISK OF DAMAGE!**

Never operate RC vehicles on public roads. Damage of vehicle and property can occur. Injury or death may also occur. Only operate on wide open private property.

**WARNING!**

Do not mix old and new batteries. Do not mix alkaline, lithium, standard (carbon zinc), or rechargeable (nickel cadmium) batteries. Do not change or charge batteries in a hazardous location.



**FCC Compliance Statement!** The radio included with your vehicle complies with part 15 of the FCC Rules. Operation is subject to the following two conditions: (1) This device may not cause harmful interference, and (2) This device must accept any interference received, including interference that may cause undesired operations. Note: This equipment has been tested and found to comply with the limits for a Class B digital device, pursuant to Part 15 of the FCC Rules. These limits are designed to provide reasonable protection against harmful interference in a residential installation. This equipment generates, uses and can radiate radio frequency energy and, if not installed and used in accordance with the instructions, may cause harmful interference to radio communications. However, there is no guarantee that interference will not occur in a particular installation. If this equipment does cause harmful interference to radio or television reception, which can be determined by turning the equipment off and on, the user is encouraged to try to correct the interference by one of the following measures:

Reorient or relocate the receiving antenna.

Increase the separation between the equipment and receiver.

Connect the equipment into an outlet on a circuit different from that to which the receiver is connected.

Consult the dealer or an experienced radio/TV technician for help.

**WARNING:** Any changes or modifications not expressly approved by the party responsible for compliance could void the user's authority to operate this equipment.

**WARNING:** While operating the Radio, a separation distance of at least 20 centimeters must be maintained between the radiating antenna and the body of the user or nearby persons in order to meet the FCC RF exposure guidelines.

# WELCOME TO HOBBY GRADE RC VEHICLES

Recommended for ages 14+ (with adult supervision)

Congratulations on your new hobby grade radio control vehicle. Hobby grade Radio Control (RCs) offer many advantages over radio controlled vehicles sold in the toy department. One of the greatest advantages of hobby grade RC vehicles is the ability to set up the vehicle the way YOU want it. This includes changing gear ratios to better suit your terrain, tuning the many adjustable suspension components like ride height and geometry, as well as customizing the overall appearance of your vehicle. Redcat Racing hobby grade RC vehicles were designed with all these characteristics in mind to provide you with much fun and adjustability.

Redcat hobby grade RC vehicles are incredibly fast! While going fast is fun and exciting, it also comes with a great deal of responsibility. An RC vehicle traveling at full speed carries much momentum. Getting hit in the leg at high speeds hurts and serious injury may occur. Property damage, as well as damage to your RC vehicle, is also possible. Great care must be used while operating these vehicles.

Redcat radio controlled vehicles are engineered for performance as well as durability. This means shedding weight where ever possible and using complex suspension components that offer many tuning options. This allows the operator to make adjustments that will affect the way the vehicle responds to all aspects of the terrain. As you may know, any RC vehicle, whether it is hobby or toy grade, can break. How and when it breaks depends solely on your driving style. Unfortunately, breakage is unpredictable. While you may break parts on a small, gentle looking crash, those big crashes, where breakage is almost guaranteed, you may not break anything. Unlike toy grade RCs, hobby grade RCs are designed with parts replacement in mind. Spare parts are readily available from Redcat and more durable aluminum parts may be available as well. It is recommended to keep spare parts on hand so if you run into that oak tree at full speed, you will have the necessary replacement parts to get you up and running again quickly.

Appearance is just as important as speed and handling. Who wants to go fast and look good doing it? You do! That is why Redcat has also designed their vehicles to look as good as they perform. Accessories may also be added to your vehicle to customize its looks. As mentioned earlier, Redcat hobby grade RC vehicles are completely customizable and that is where all the fun is.

Imagine yourself being on the pit crew of a full scale race team, making suspension adjustments for better handling or changing the gearing to get that hole-shot from the start. That is the feeling you will get when adjusting the suspension on your new Redcat. Increase ride height so you can clear the driveway with a single jump or thicken the oil inside the oil filled shocks to make high speed laps around your front yard. The possibilities are endless with Redcat, so put on your favorite pit crew cap, grab your Redcat and have the time of your life!

STOP

## WARNING

STOP

This is not a toy and should not be treated as one. 2-stroke gas engines are highly tuned pieces of equipment and need to be used only as directed. Follow the included instructions closely and keep hands away from hot surfaces, such as the engine and exhaust pipe.

Make sure you read all included manuals completely before attempting to start your 1/5 scale vehicle.

The engine in this RC vehicle runs on a mixture of unleaded gasoline and 2-stroke motor oil. This is a special oil designed for use in 2-stroke engines by mixing it with the gasoline. Regular 4-stroke motor oil will not work. Only use the specified gas/oil mixture ratio. Improper mixtures can cause damage and potential injury. Gas is dangerous for many reasons. It's flammable, has explosive fumes, and is poisonous. Handle with care. Gasoline should be used by a responsible adult and should be kept from children. Never use near an open flame! Never breathe in the fumes! Always wear protective eye wear, gloves, and clothing. Store in a cool dry place. Never store gasoline in your home.

# REQUIRED EQUIPMENT

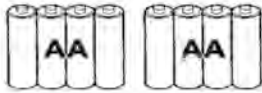

AA batteries for transmitter  
(Number of batteries may vary per vehicle)

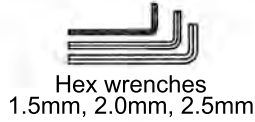

Hex wrenches  
1.5mm, 2.0mm, 2.5mm

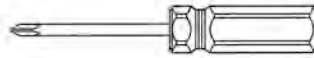

Flat & Phillips screwdrivers

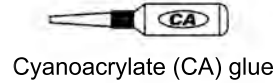

Cyanoacrylate (CA) glue

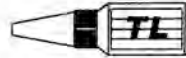

Thread locking compound

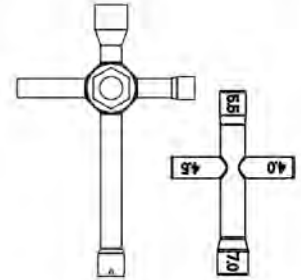

Large & small cross-wrenches



100% Unleaded Gasoline



Air filter oil



2-stroke oil

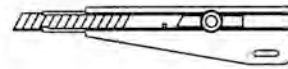

Hobby knife

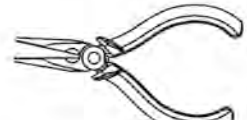

Needle nose pliers

**Note:**

This vehicle requires a receiver battery (included) and high quality unleaded gasoline mixed with 2-stroke oil to run. Be sure to mix the correct gas:oil ratio as stated in this manual.

# RECOMMENDED EQUIPMENT

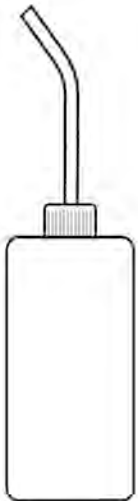

Filler bottle



Polycarbonate scissors



Body reamer



Silicone oil



Silicone grease



Spare receiver battery

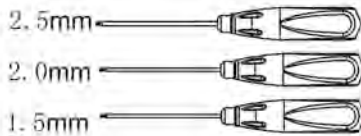

Hex drivers

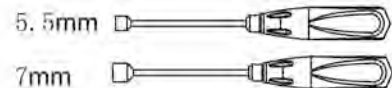

Socket drivers

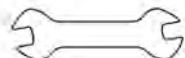

Wrench, 5.5mm



Precision ruler

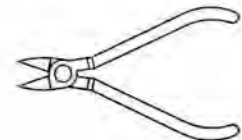

Wire cutters

**WARNING:**

Never use a drill or powered screw driver while working on RC vehicles. The heat generated from fast turning screws can melt the threads inside the plastic. This can cause loose parts, resulting in poor performance, premature wear, and breakage.

# INTRO TO GASOLINE ENGINES

## Gas Engines:

Knowing and understanding the different parts of your engine is important. Study the images below and become familiar with the different engine parts. Knowing what each part is called and where it is located on the engine will help you understand break-in and tuning instructions.

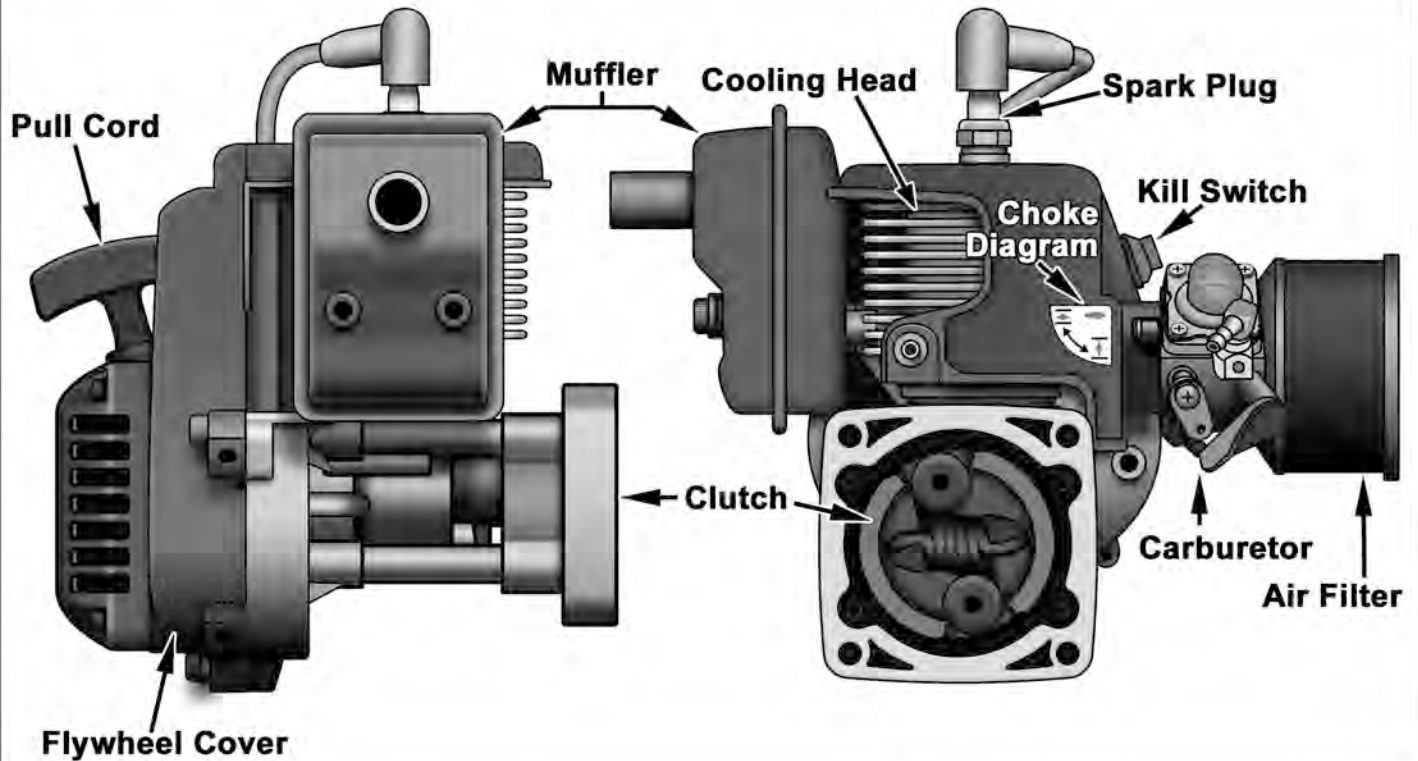

## CARBURETOR

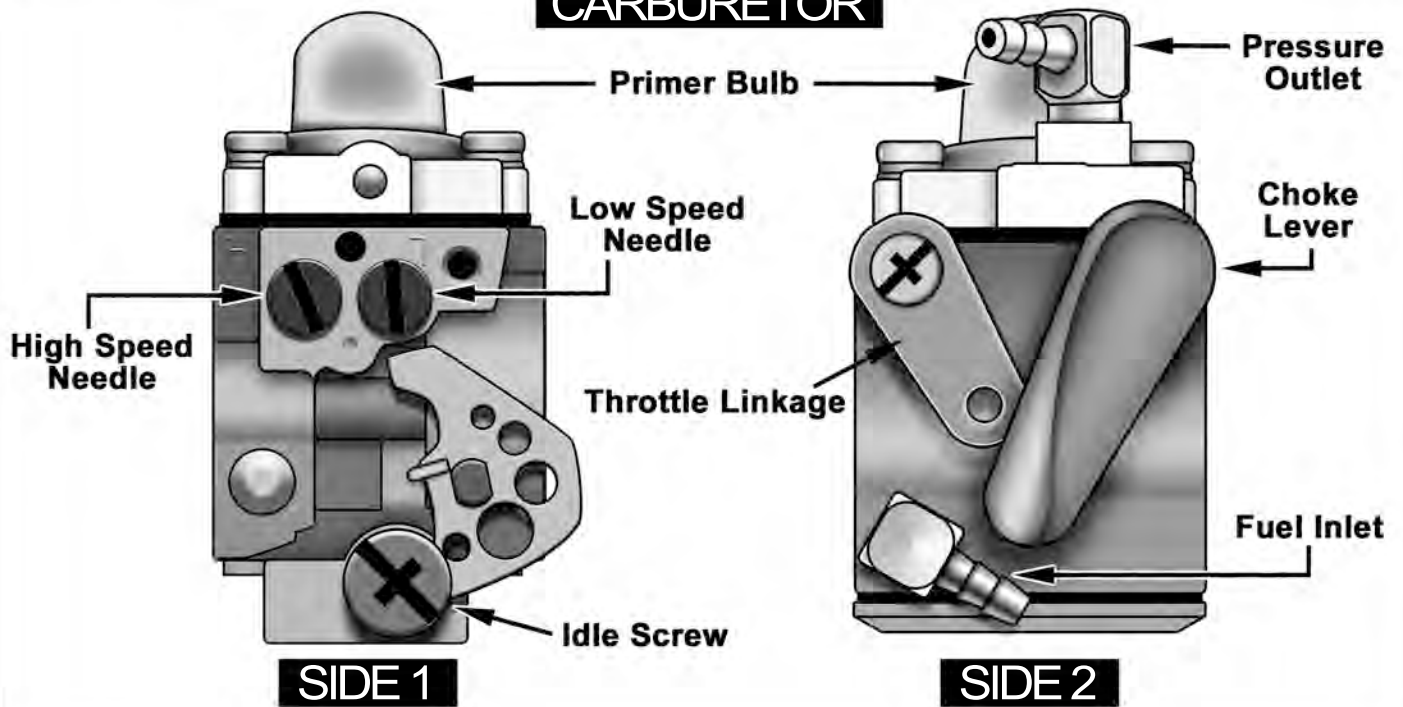

# UNPACKING & SET-UP

## Unboxing your Redcat Racing RC vehicle:

Be sure you've removed all parts, equipment, tools, and documentation from the box. It's easy for small parts to get hidden in the packing materials and be overlooked.

Completely read all documents and instructions included with your Redcat Racing vehicle.

Acquire any necessary items such as transmitter batteries, receiver battery, receiver battery charger, gasoline, two-stroke oil, mixing container, and any additional tools and supplies needed.

## Looking over your new Redcat vehicle:

Be sure to look over your new Redcat RC. This will save you time and trouble in the future. Do the following:

Check all screws to make sure they are tight. Do not over tighten screws nested into plastic as this may damage the plastic threads. Avoid using power tools for this step.

Check all nuts, bolts, and clips to ensure they are tight and secure.

Add medium strength liquid thread lock (like blue Loctite) to any screws threaded into metal parts, especially the motor mounts. Do not apply threadlock to screws threaded into plastic parts; this may damage the plastic threads. Threadlock can be found at auto parts stores. **NEVER USE PERMANENT THREADLOCK!** Heat is necessary to remove parts secured with permanent threadlock (like red Loctite). This will damage your RC vehicle.

## Lube the Air Filter:

Lube and install the air filter onto the engine's carburetor if it is not already done. The air filter used on RC vehicles uses a sticky oil treatment to aid in filtration and keep damaging dust out of the combustion chamber. Failure to soak the filter in this oil will void the engine's warranty and possibly damage the motor. You can find air filter pre-treatment oil at a local hobby shop.

To apply the filter pretreatment oil, place the filter element in a sandwich bag. Add about a teaspoon of air filter oil into the bag. Using your fingers, work the oil into the filter. The plastic bag keeps your hands clean and allows you to see your progress. Add more oil if needed. If too much oil has been used, wrap the filter element in a paper towel and squeeze out the excess oil. Too much oil can restrict air flow.

## Perform a radio range check:

Install new AA batteries into the bottom of the transmitter, as shown to the right.

Thread the vehicle's antenna through the plastic antenna tube and turn on the transmitter. Turn on the receiver switch, which is found in the vehicle. Check that the controls are working properly.

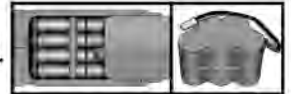

Keeping fingers away from potentially moving parts; hold the vehicle off the ground and turn on the Electronic Speed Controller (ESC) switch found in the vehicle. Always turn on the transmitter first to prevent runaways.

Check that the controls are working properly. The steering wheel should operate the steering and the trigger should operate the motor. Pulling the trigger should make the vehicle go forward pushing the trigger should apply the brake and reverse. You may need to adjust the throttle trim found on the transmitter to keep the wheels from spinning while the trigger is in the neutral position.

Have a buddy hold the vehicle and walk 50 yards away. You and your buddy should decide on a routine beforehand, since it will be difficult to communicate with each other while testing. An example would be . . . turn the steering wheel left and count to ten; turn the steering wheel right and count to ten; pull the trigger and count to ten, and push the brakes and count to ten. You will want to repeat these steps moving further out as you progress until you are beyond the maximum distance you plan to run the vehicle.

If the radio performed without any glitches or twitching at maximum distance, you are ready.



# ENGINE STARTING & BREAK-IN PROCEDURE

Although the absolute minimum of running the engine lightly for 1/2 tank of gas and calling it broken in is done by many, we at Redcat Racing have done much research regarding what we believe is the best way to break in a high performance 2-stroke gas engine. Our research has shown that bringing the engine through several heat cycles provides the best results to achieve the best performance and longest engine life possible from your new Redcat Racing 1/5 scale high performance vehicle. We believe that by putting forth some effort now, you will be greatly rewarded in the future. These high performance engines run on a mixture of 90-93 octane gasoline and two cycle engine oil. A mixture of 20: 1 (gas: oil) will be used for break in and 25: 1 (gas: oil) can be used for regular running after the entire break in period is complete.

## Engine Starting:

1. After the vehicle has passed a radio range check, turn on both transmitter and vehicle.
2. Fill the vehicle's gas tank with the correct gas/oil mixture.
3. Press the primer bulb until it fills with gasoline. Now, press three more times.
4. Set the choke lever to full (closed) choke.
5. Pull the starter cord until the engine tries to start.
6. Set the choke lever to the open position and pull the starter cord again until engine starts.
7. If the engine doesn't start within 10 pulls, repeat steps 3-5.

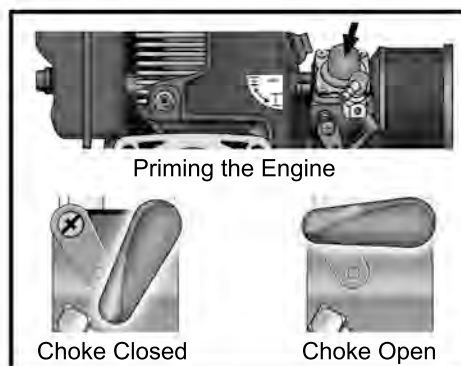

## Break in Procedure:

1. Using the 20:1 gas/oil mixture, fill the vehicle's gas tank to the top. Start the engine, as directed above, and run the vehicle for the first 1/2 tank of gas while repeatedly varying the speed of the engine from stop to 1/2 throttle. Do NOT exceed 1/2 throttle. When you are left with only 1/2 tank of gas, let the engine idle 30 seconds and turn off by pressing the red kill switch. **Never let the vehicle run out of gas during break in.**
2. Let the engine cool for ten minutes. (You have now completed one heat cycle.)
3. Repeat step one for a total of 3 full tanks of fuel letting the engine cool for ten minutes at every 1/2 tank interval. That's a total of 6 heat cycles. Remember to fill the gas tank between heat cycles so you don't chance running the tank dry during break in.
4. Fill the tank with more of the 20:1 gas/oil mixture and run the vehicle from a stopped position to full throttle and back to stop. Remain stopped for a few seconds and repeat. Do this for 1/2 tank of fuel. Let the engine idle for 30 seconds and then turn off the engine by pressing the red kill switch.
5. Let the engine cool for ten minutes.
6. Repeat step 4 for one more 1/2 tank.
7. Let the engine cool for ten minutes.
8. Use the remaining gallon of fuel mixed at 20:1 while driving normally.
9. Let the engine cool ten minutes in between each full tank of gas.
10. Break in is now complete. You may mix a 25:1 fuel/oil ratio from here on out.

# ENGINE TUNING

## How an Engine Works:

Inside the combustion chamber, where the piston is found, four things are needed for a properly working engine. Fuel (gas/oil mixture), air, compression, and spark are all needed. Fuel is needed to burn, air is needed to make the fuel burn hotter, and compression is needed to make it burn even hotter resulting in an explosion when the spark fires.

Fuel is mixed with air in the carburetor; this mixture is then sent to the combustion chamber. This is where the piston pushes up on the fuel/air mixture compressing it tight. The fuel is then ignited by the spark plug which causes an explosion forcing the piston down which in turn, rotates the crank shaft providing power to the drive train. This process happens over and over very quickly. When adjusting the high and low speed mixture screws, we refer to a rich mixture and a lean mixture. A rich mixture has a higher ratio of fuel to air than a lean mixture. To richen the mixture, you add more fuel and to lean out the mixture, you use less fuel. You have of course already mixed the proper ratio of oil into the fuel, so a rich fuel/air mixture has more fuel/oil than a lean mixture.

**WARNING: Running your engine too lean will cause damage from friction and overheating!**

To control the amount of fuel in our fuel/air mixture, we use adjustment needles. There is a high speed needle and a low speed needle. We always start adjusting the high speed needle first.

Note: The needles have been set and tested at the factory. Only adjust if absolutely necessary.

## Tuning the High Speed Needle:

After break-in has been completed, you may tune your engine for optimal performance. The engine should always be at running temperature before making any adjustments. Never tune a cold engine! Bring the engine up to running temperature by running the vehicle around for a few minutes.

The first step in tuning is figuring out which way to tune. Do we need to make it richer or leaner? The easiest way to do this is by using the choke. If the engine seems to be bogged down at full throttle and is emitting plenty of smoke, set the choke 1/2 way in between open and closed. If the engine's performance improves, you know the engine is running too lean and needs to be richened by turning the high speed needle counter clockwise. If performance declines, you may need to lean out the fuel/air mixture by turning the high speed needle clockwise. How does that work? When closing the choke, you restrict the air flow creating a higher ratio of fuel to air which results in a richer fuel/air mixture. The amount you close the choke directly affects the fuel/air ratio.

Run the vehicle at full throttle. There should be a healthy amount of smoke exiting the exhaust pipe. Making adjustments in 1/8 turn intervals, turn the high speed needle (refer to engine diagram) clockwise to lean out the fuel/air mixture or counter clockwise to richen the mixture. Once maximum speed and smooth sound are obtained, turn the high speed needle counterclockwise 1/8 turn. This is the best setting for performance and longevity. Double check for smoke coming out of the exhaust. If there is NOT a healthy amount of smoke coming out of the exhaust, richen up the fuel mixture by turning the high speed needle counter-clockwise another 1/8 turn until proper smoke is visible. Remember, if smoke is not visible, you are not lubricating your engine. The factory high speed needle setting is 1.5 turns out from fully closed.

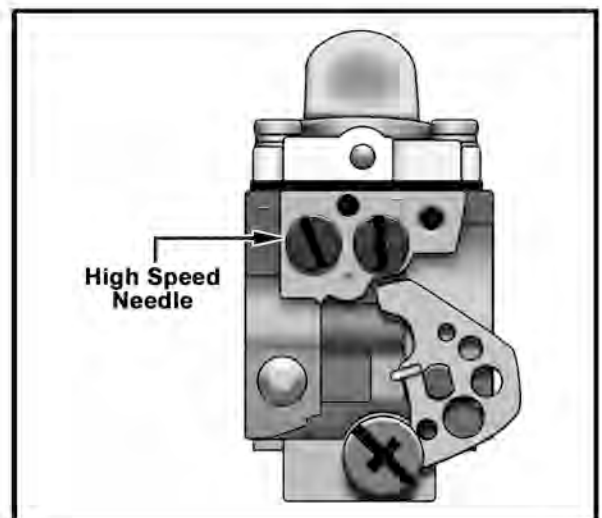



# ENGINE TUNING

## Tuning the Low Speed Needle:

Now that the high speed needle is properly set, you may adjust the low speed needle. To do this, follow these steps. Remember! Never tune a cold engine!

1. Before beginning, listen to the engine while idling and then hit the throttle. If the engine idles smoothly and accelerates well, you are done. If not, continue to the next step.
2. With the engine idling, follow the same steps used in determining the high speed mixture. Close the choke slightly and listen for a change in the engine. If the engine runs smoother, you need to richen the low speed needle by turning it counter clockwise. If the engine runs worse, you need to lean out the low speed needle by turning it clockwise.
3. Making adjustments in 1/8 turn intervals, turn the low speed needle (refer to engine diagram) clockwise to lean out the fuel/air mixture or counter clockwise to richen the mixture.
4. From a stopped position, quickly pull the trigger to full throttle. The engine should get to top speed smoothly with little hesitation. If it does not, you may fine tune the low speed needle to ensure it does. Start by turning the low speed needle clockwise 1/16 turn. Notice the change and repeat this step as needed. Once smooth acceleration is reached, loosen the low speed needle 1/16 turn.
5. If the engines performance decreases, sputters, gurgles, and stalls with little to no smoke, it may be too lean. Turn the needle counter clockwise 1/16 turn until smoke is visible at 1/4 throttle. The factory low speed needle setting is 1.25 turns out from fully closed.

## Setting the Idle:

Idle is set from the factory and should only be changed if the engine is tuned properly and still has difficulty idling without stalling.

### If the Engine Stalls During Idle:

Tighten the idle screw 1/16 turn. Test the engine and repeat if necessary. The idle speed should remain as low as possible without stalling. Higher idle speeds cause erratic performance and excessive wear on the clutch.

### If the Vehicle Drives Forward During Idle:

First, be sure the throttle plate is rotated firmly against the idle screw. If not, adjust the throttle trim on the radio transmitter. See the vehicle manual for instructions on adjusting the transmitter. If the throttle plate is firmly against the idle screw, turn the idle screw slowly until the idle slows enough for the vehicle to sit still without rolling forward. This should provide a smooth low idle.

If the engine idles rough and stalls, tighten the idle screw 1/16 turn and restart the engine. Test the engine and repeat, if necessary.

The idle speed should remain as low as possible without stalling. Higher idle speeds cause erratic performance and excessive wear on the clutch.

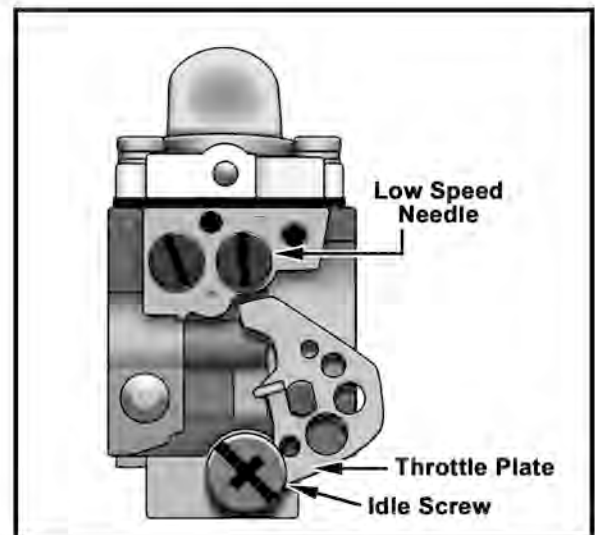

# MAINTENANCE

There is much fun to be had running RC vehicles. To ensure continued fun throughout the years, here are some maintenance tips to follow.

## Chassis Cleaning:

Many substances such as dirt, grass, & grime can find its way onto your RC chassis. It's a good idea to clean this off after each day's use. There are many ways to clean an RC vehicle. Here are a few examples.

One of the most effective ways to clean the chassis is with an old tooth brush, cotton swab, old paint brush, and rag. These four tools work well for removing dirt and debris.

Pay close attention to areas with moving parts such as suspension components, steering components, and drive train. It is important to get these areas clean to help prevent wear.

Unburned 2-stroke oil can easily be removed with nitro car cleaner, sold at hobby stores. Read the instructions on the can carefully before using.

## Bearings:

Running your vehicle through water is never recommended, but moisture may still make its way into the vehicles bearings. Here are some tips on drying, cleaning, and oiling the bearings.

Your Redcat Racing vehicle may have bearings in various locations like wheel hubs, steering linkages, gear supports, and drive shaft supports. First, you must have access to all the bearings. Remove all four wheels and any other parts blocking bearing access.

Spray the bearings with a water displacer such as WD40 or Wire Dryer. This will flush out moisture, dirt, and grime.

After a good spraying with a water displacer, the bearing will be in need of oil. Use a light bearing oil which can be purchased at the hobby shop or auto parts store. \*This step is important\* Failing to re-oil the bearing will cause them to wear prematurely and replacements will be necessary. A few drops of oil per bearing should be fine. Spin the bearing to work the oil throughout the bearing.

## Screws and Moving Parts:

It's a good idea to quickly go over the entire vehicle after each run to ensure all screws remain tight. Make sure there isn't any excess motion or "slop" in moving parts.

Medium thread lock (like blue Loctite) should be used on any screws that fasten into metal parts, especially the motor mount. Never use permanent thread locker on any part of your RC vehicle. Permanent thread locker (like red Loctite) can only be removed with heat, which will cause damage to the vehicle.

Checking for cracks and excess wear is also a good way to save yourself some headaches down the road.



# MAINTENANCE

## Engine Maintenance:

After a day of running your gas vehicle, be sure the fuel tank is empty and all gasoline has been burned out of the engine. Ethanol, found in some gasoline, absorbs moisture which causes corrosion. To help protect your engine against corrosion and rust, use 100% gasoline. This is gasoline that is free and clear of ethanol. After emptying the fuel tank, restart the engine so any remaining gasoline will be used up. Clean off the engine with an old paint brush and/or some compressed air to remove any excess dirt and debris.

Remove the air filter being careful not to let anything fall into the carburetor. Clean the air filter with soap and water, if needed. A dirty air filter will cause the engine to starve for air resulting in a rich fuel mixture. Remember to let the air filter dry completely before re-oiling. Oil the air filter with "air filter pretreatment oil" after each cleaning. You can buy air filter oil at your local hobby shop. Install the air filter back onto the carburetor to keep debris from entering the engine.

It's a good idea to check the spark plug after every five tanks of fuel. After thoroughly cleaning the head (top of engine with cooling fins) with a cotton swab, remove the spark plug by unscrewing it with a socket. Check the tip of the spark plug (where the spark happens). If you see any oil or carbon build up, spray it off with some carburetor cleaner. If the engine won't start or if it runs erratically, it's a good idea to check the spark plug for build up or damage. Clean or replace if needed.

Long term storage: When storing your vehicle for long periods of time without use, make sure you've emptied the gas tank and used up any leftover fuel inside the engine. If the gasoline you are using contains ethanol additive, you may want to add some after run oil, or spray some WD40 into the spark plug and carburetor holes. This will help protect your engine during long periods.

## Electronics:

Be sure to check your electronics after each use. The electronics are the life line of the vehicle and if they aren't working properly, a crash is almost certain.

Periodically range check your radio system to ensure proper operation.

Check batteries regularly. It is important to have fresh batteries in the transmitter.

Check the antenna on both the receiver and the transmitter. Make sure there are no cuts or breaks in the receiver antenna. This will cause glitches and possible signal loss.



Using the transmitter, check the steering servo by turning the wheel back and forth. Check that it is operating smoothly and no clicking noises can be heard.

Make sure all electronics stay dry, even in waterproof vehicles. Water can short out the circuit boards inside the electronics causing failure.

# TROUBLESHOOTING GAS

## Engine won't start: Fill the fuel tank with the correct gas/oil mixture:

1. Engine isn't primed. Press the primer bulb (fig.1) until you see fuel in it. Now, press three more times.
2. Engine is cold. Rotate the choke lever to the closed position (fig.2) and pull the starter cord until the engine tries to start by firing once. Now, open the choke (fig.3) and start the engine.
3. Spark plug is bad or dirty. Check the spark plug by removing it from the engine. If either the center or grounding electrode is dirty, spray off with carburetor cleaner (fig.4). If either electrode is corroded, broken, or worn down (fig.5), replace the spark plug.
4. Incorrect needle valve settings. Set both high and low speed needles back to factory settings. Gently turn both needles clockwise to close them. **DO NOT OVER TIGHTEN** as this can damage the valve seat. Turn the low speed needle 1.25 turns counter-clockwise and turn the high speed needle 1.5 turns counter-clockwise (fig.6). These are the factory settings, and you can proceed to tune the engine from this point.

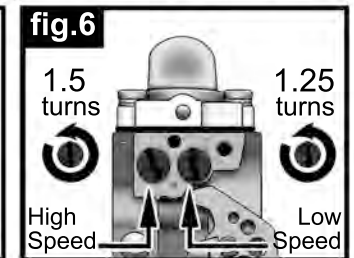
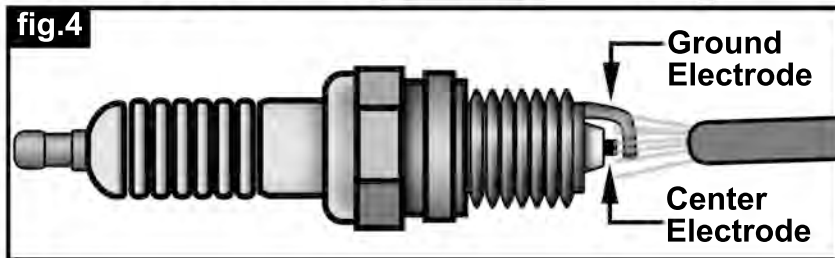
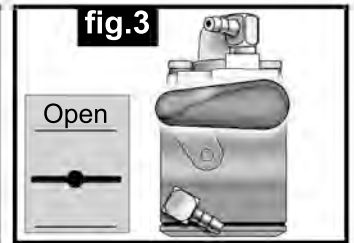
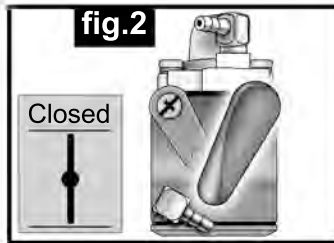

## Vehicle ran away with no control:

Make sure you turned on the radio and receiver.

Batteries in the vehicle are run down. Recharge the receiver pack (fig.6).

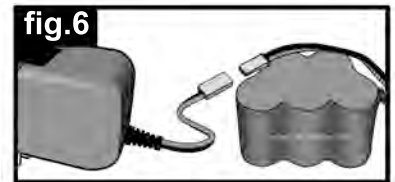
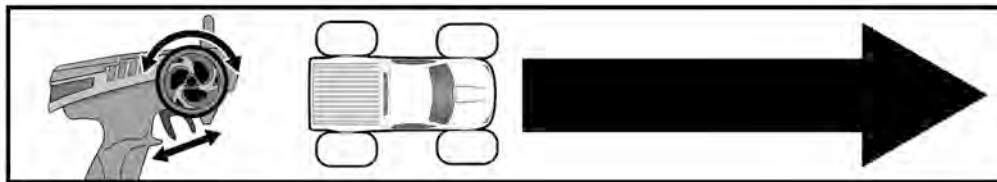

## Vehicle Drives Forward/Backward But Won't Steer Left/Right:

Steering dual rate is set too low. Turn the steering dual rate knob counterclockwise.

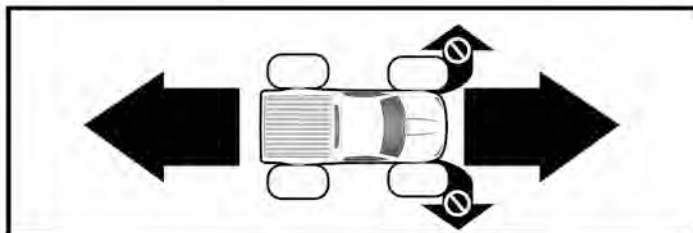

# DRIVING TIPS

## Perspective:

The single most difficult aspect of driving RC vehicles is perspective. Perspective involves your relation to the vehicle. Are you behind the vehicle, in front of the vehicle, or beside it?

Driving an RC vehicle while standing behind it is like driving a full size car or go-cart. When you turn left, it goes to the left and when you turn right, it goes to the right.

What if the vehicle is coming toward you? When you turn the wheel to the left, will it go toward your left? No! Because the vehicle is coming toward you, the controls seem reversed. The controller doesn't actually change, it just seems like it does because of perspective.

Always imagine yourself sitting inside the vehicle, not standing outside with a remote. Imagine you are driving and the wheel on the remote is the actual steering wheel inside the car. Keeping this mind-set will help you make the correct steering decisions no matter which direction the RC vehicle is pointed.

Driving Away

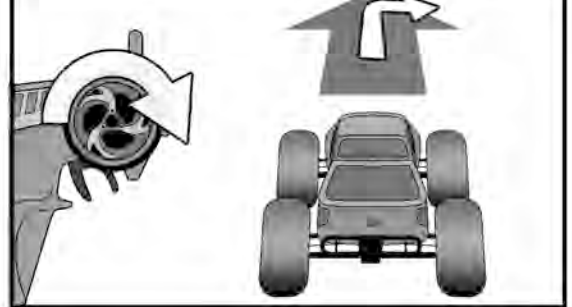

Driving Toward

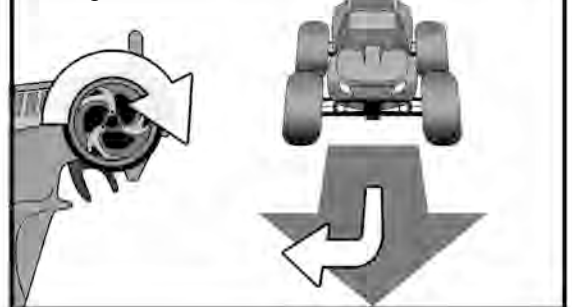

## Steering and Throttle Control:

The steering and throttle inputs are both proportional. This means slightly pulling the trigger will make the RC vehicle move slowly. Pulling the trigger all the way back will cause the RC vehicle to go fast. The same applies to the steering.

The most common mistake with new RC enthusiasts is over correction. Over correction is when a slight amount of steering or throttle is needed and full throttle or steering is applied causing "crazy driving." It's a good time to learn how to control your movements. This may sound silly, but nerves and adrenaline have a lot to do with over correction. It is sometimes difficult to control our movements when we are over excited. I promise you, when your Redcat vehicle blasts across your yard and the grass starts flying, you will get excited.

As you become more familiar with your RC vehicle, you will tend to relax a little more making it easier to concentrate on making small control inputs instead of great big ones.

## Look Ahead:

While controlling an RC vehicle it's important to look where it's going instead of where it's been. Looking a good five-to-fifteen feet in front of the vehicle will give you time to react to uncertain obstacles. It also prevents trees from jumping out in front of you.



## STOP! BEFORE JUMPING YOUR VEHICLE READ THIS!

Jumping RC vehicles does not usually yield the same results found in online videos. It may have taken many tries and broken parts to nail that huge jump on camera. You assume full responsibility for any damage that results from jumping your Redcat Racing RC vehicle. Redcat assumes no responsibility if you decide to jump or do stunts using your Redcat RC vehicle.

# ADVANCED DRIVING TIPS

As you become comfortable driving your Redcat RC vehicle, you may want to drive smoother and with more precision so you can go faster. Here are a few driving tips that are sure to add some excitement.

## Drifting:

Driving on loose surfaces like dirt or gravel can be fun, but how do you keep from spinning out? Counter steering is the answer to that question. Here is a rule of thumb. Always keep the front tires pointed in the direction you want the car to go. This is true regardless of which direction the vehicle itself is pointed.

Here is an example: Let's say you are driving in loose dirt. You are traveling at full speed and you want to make a left hand turn while maintaining most of your speed. You turn the wheel left spinning the vehicle 360 degrees resulting in a complete loss of speed.



Try this! Get the RC up to full speed again, only this time, turn left and when the vehicle starts to spin, turn right keeping the front tires pointed where you want the car to go. When done correctly, the vehicle will enter into a slide or "drift" allowing you to turn while maintaining most of your speed. Practice this many times in both directions and you'll be drifting like a pro.



## STOP! BEFORE JUMPING YOUR VEHICLE READ THIS!

Jumping RC vehicles does not usually yield the same results found in online videos. It may have taken many tries and broken parts to nail that huge jump on camera. You assume full responsibility for any damage that results from jumping your Redcat Racing RC vehicle. Redcat assumes no responsibility if you decide to jump or do stunts using your Redcat RC vehicle.

## Jumping:

When done correctly, jumping is by far the most impressive maneuver done with RC vehicles. All RCs can go up, but how they land determines whether it was a successful jump. Anyone can hit a jump at full speed; I'm going to teach you how to land on all four tires. The wheels on an RC vehicle act as gyroscopes. All this really means is you can drive the vehicle while it's in the air. The amount of throttle or brake applied while in mid flight will control whether the nose is up or down. Applying throttle will raise the nose and applying brake will lower the nose.

This is good to know if you hit a jump and your vehicle's nose is pointed at the ground. Hit the gas! Hitting the gas will raise the nose to help level out the landing. The amount of throttle used is in direct relation to the amount of correction needed. Be careful landing while on the throttle can strip gears.

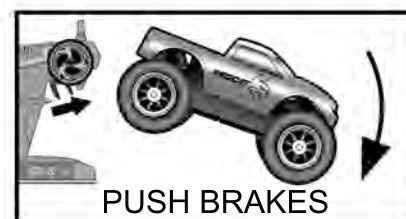
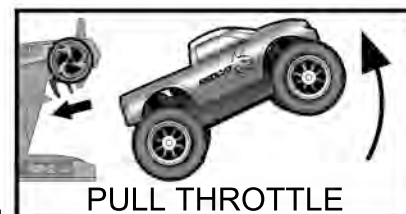

Adding steering input in conjunction with throttle inputs will cause a whole new outcome. Let's say you are in mid flight, your left front tire is closest to the ground, and you want to level the vehicle out. In this case you would steer left and apply throttle. This will raise the left front tire. Applying too much throttle will raise the left front tire too high. Here is a good rule of thumb. Steer into the front corner of the vehicle you want to correct and apply the appropriate trigger response.

Remember, applying throttle raises the nose and applying the brake lowers it. This will take a lot of practice, so be sure to have some spare parts on hand. Bad landings can do lots of damage.



# SETUP TIPS

Redcat Racing cars, trucks, and buggies offer many tuning options to help you achieve the exact feel you like in a vehicle. These tuning options include shock position, ride height, camber, toe in or out, shock stiffness, and over all suspension geometry.

## SHOCK POSITION:

Shock position plays a big role in how your vehicle handles bumps as well as turning stability. The effects of shock position affect the area of the vehicle you change. For instance, if you change the front shock positions, it will affect the traction and stiffness of the front tires.

### FRONT SHOCK POSITION:

#### **POSITION: TOP=1 & BOTTOM=3:**

The straighter up and down the shock is, the stiffer it will feel. This may also decrease bump handling stability as well as decrease traction. The benefit of this position is increased steering response.

#### **POSITION: TOP=3 & BOTTOM=1:**

Shocks in a more leaned position will give a softer feel. This increases bump stability and front traction, however, it decreases steering response.

### REAR SHOCK POSITION:

#### **POSITION: TOP=1 & BOTTOM=3:**

The straighter up and down the rear shocks are, the stiffer the feel. This decreases rear traction which increases steering, but gives less stability over bumps.

#### **POSITION: TOP=3 & BOTTOM=1:**

Leaning the rear shocks in decreases steering by providing more rear traction and increases bump stability.

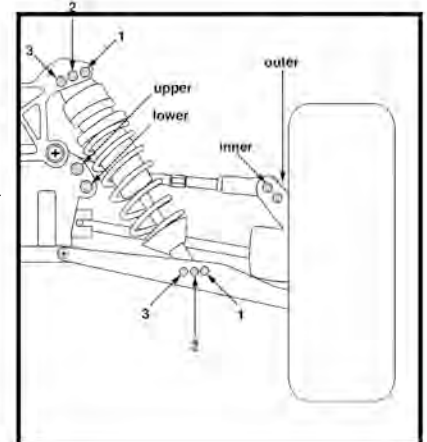
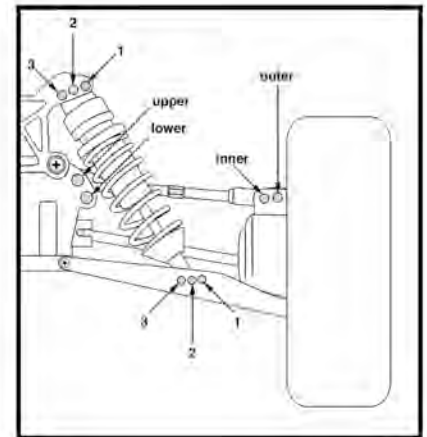

## RIDE HEIGHT:

Adjust ride height by moving the top spring collar up or down on the shock body. Increasing ride height allows you to drive over larger obstacles but also raises the vehicle's center over gravity (COG). A higher COG means less stability. Decreasing ride height increases stability but decreases the size of the obstacles you can maneuver over.

## SHOCK OIL:

Heavier weight shock oil (bigger number) will provide more dampening and slow down the speed at which the shock travels. This will reduce chassis roll for more stability.

Lighter weight shock oil (smaller number) will offer less dampening allowing the shock to recover quicker. This is better for rough terrain but offers less high speed stability from increased chassis roll.

# SETUP TIPS

## UPPER LINK ADJUSTMENTS:

Adjusting the upper link affects the vehicle's "roll center." Adjusting "roll center" will affect the way the chassis rolls at its center of gravity. There are two mounting positions to choose from on the chassis side and hub carrier side of the upper link. Two things to watch for are upper link length and upper link angle.

## UPPER LINK LENGTH:

The longer the upper link, the more the chassis wants to roll in turns. While chassis roll may not seem good, it adds traction in the turns. This is good for a loose track where much traction is needed. The shorter the upper link, the less the chassis will roll. This is good for a high bite track where stability is needed.

## UPPER LINK ANGLE:

The angle of the upper links also affect chassis roll.

## PARALLEL UPPER LINK:

When the upper link is parallel (level) to the lower arm, the chassis has a tendency to roll more giving more cornering traction on low grip tracks.

## ANGLED UPPER LINK:

You must first understand, when I refer to an angled upper link, I'm referring to the inside of the link angling downward. This will give the vehicle a more stable feel with less overall traction. This is good for high bite tracks where stability is needed.

## FRONT OR REAR:

Keep in mind, changes made to the rear affect the rear and changes made to the front affect the front. Both front and rear traction affect the vehicle's turn ability. Less traction in the front will make the vehicle more difficult to steer, but less traction in the rear will make the vehicle steer more easily.

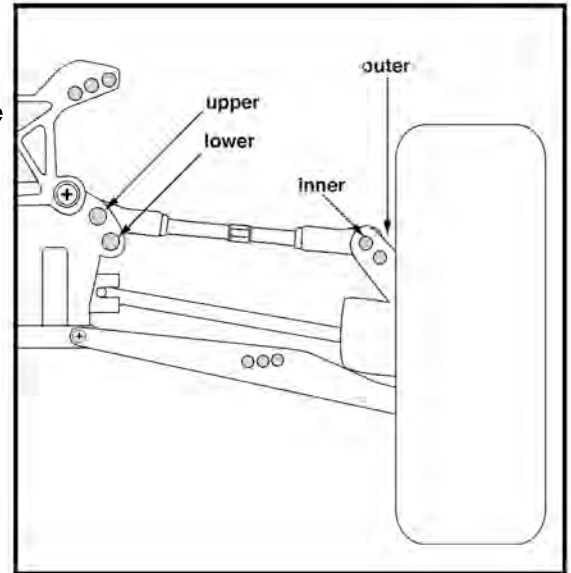

## TOE IN & OUT:

Toe in and out refers to whether the front of the tires are angled in or out.

**TOE OUT:** Toe out gives less straight line tracking and a "darty feel" (quick jerks side to side) but more steering. 2 degrees of toe out is usually good for the front.

**TOE IN:** Toe in gives less steering and more straight line tracking. 2 degrees of toe in is usually good for the rear.

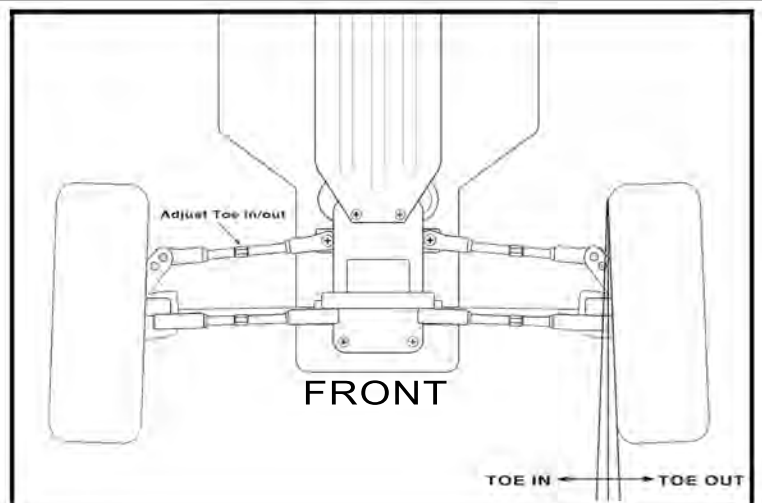

# SETUP TIPS

## CAMBER:

Camber is the vertical angle at which the tires sit in relation to the ground.

### NEGATIVE CAMBER:

Adding little negative camber (1-2 deg.) will lean the tops of the tires inward providing more traction while cornering.

### POSITIVE CAMBER:

Adding little positive camber will lean the tops of the tires outward providing much less traction while cornering.

Positive camber is usually not used.

### NEUTRAL CAMBER:

No camber added will set the tires straight up and down offering the most straight line traction but slightly decreased traction while cornering.

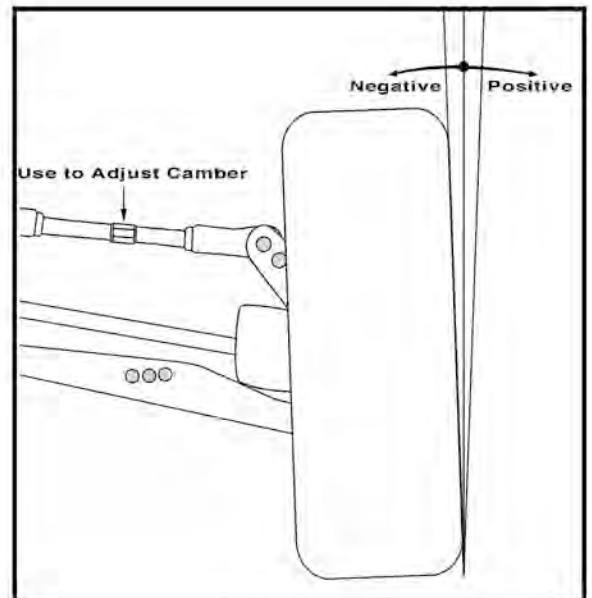

## CLUTCH ADJUSTMENTS (advanced tuning):

Redcat Racing gas vehicles are equipped with a centrifugal clutch system that engages as the engine revolutions per minute (RPMs) are increased. This allows the vehicle to sit still while idling and provides full power to the wheels while the throttle is pulled. The clutch uses springs to regulate the point of engagement and can be adjusted if needed, though we recommend you use it with the factory setup.

### DELAYED ENGAGEMENT:

The spring in the centrifugal clutch can be replaced with a heavier one to delay the clutch engagement. This will require higher engine RPMs to engage the clutch, making initial take off more abrupt with increased wheel spin. This tends to jar the drive train and may cause breakage.

### EARLY ENGAGEMENT:

The spring in the centrifugal clutch can be replaced with a lighter one to allow quicker engagement. This will require less engine RPMs to engage the clutch, making initial take off more sluggish with decreased wheel spin. This may tend to bog the engine down some during initial take off.



## GEARING:

Gearing the vehicle down will provide more initial power and less top speed. Gearing the vehicle up will provide more top speed and less initial power.

### GEARING UP:

There are two ways you can gear up for more speed. Increase the size (more teeth) of the pinion gear (small gear attached to the motor) or decrease the size (less teeth) of the spur gear (large gear on the slipper clutch).

### GEARING DOWN:

There are two ways to gear the vehicle down for more power. Decrease the size (less teeth) of the pinion gear (small gear attached to motor) or increase the size (more teeth) of the spur gear (large gear on slipper clutch)

# SETUP SHEET

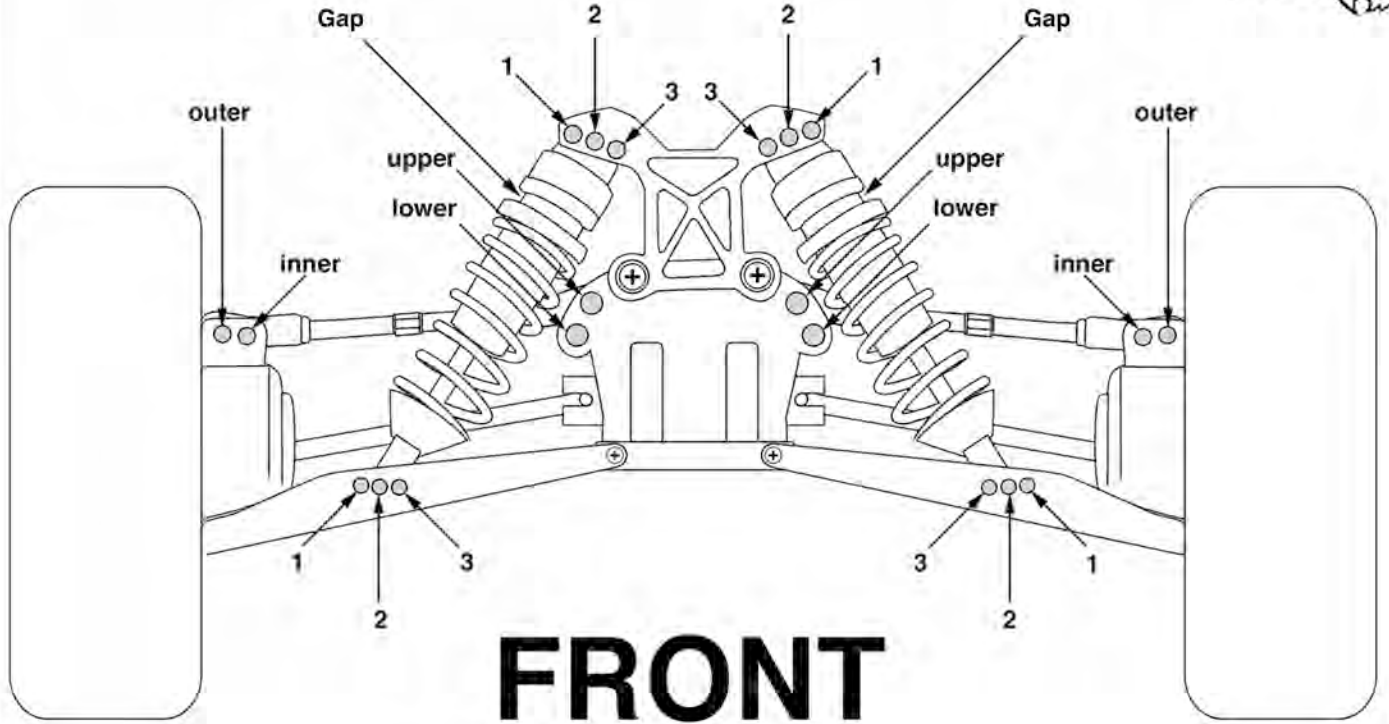

**Shock Position:**

Top: 1  2  3   
 Bottom: 1  2  3

**Upper Link Position:**

Inside: Upper  Lower   
 Outside: Inner  Outer

Shock oil: \_\_\_\_\_ wt.

**Camber Deg:**

Negative: \_\_\_\_\_ degrees  
 Positive: \_\_\_\_\_ degrees

Spring pre-load "Gap": \_\_\_\_\_ in.

Ride Height Rear: \_\_\_\_\_ in.

**Toe:**

In: \_\_\_\_\_ degrees  
 Out: \_\_\_\_\_ degrees

Piston inserts: \_\_\_\_\_ (1, 2, or 3 holes)

Front Diff Oil: \_\_\_\_\_ wt.

**Additional notes:** \_\_\_\_\_

Center Diff Oil: \_\_\_\_\_ wt.

\_\_\_\_\_  
 \_\_\_\_\_  
 \_\_\_\_\_  
 \_\_\_\_\_  
 \_\_\_\_\_

Tires: \_\_\_\_\_

Inserts: \_\_\_\_\_

# SETUP SHEET

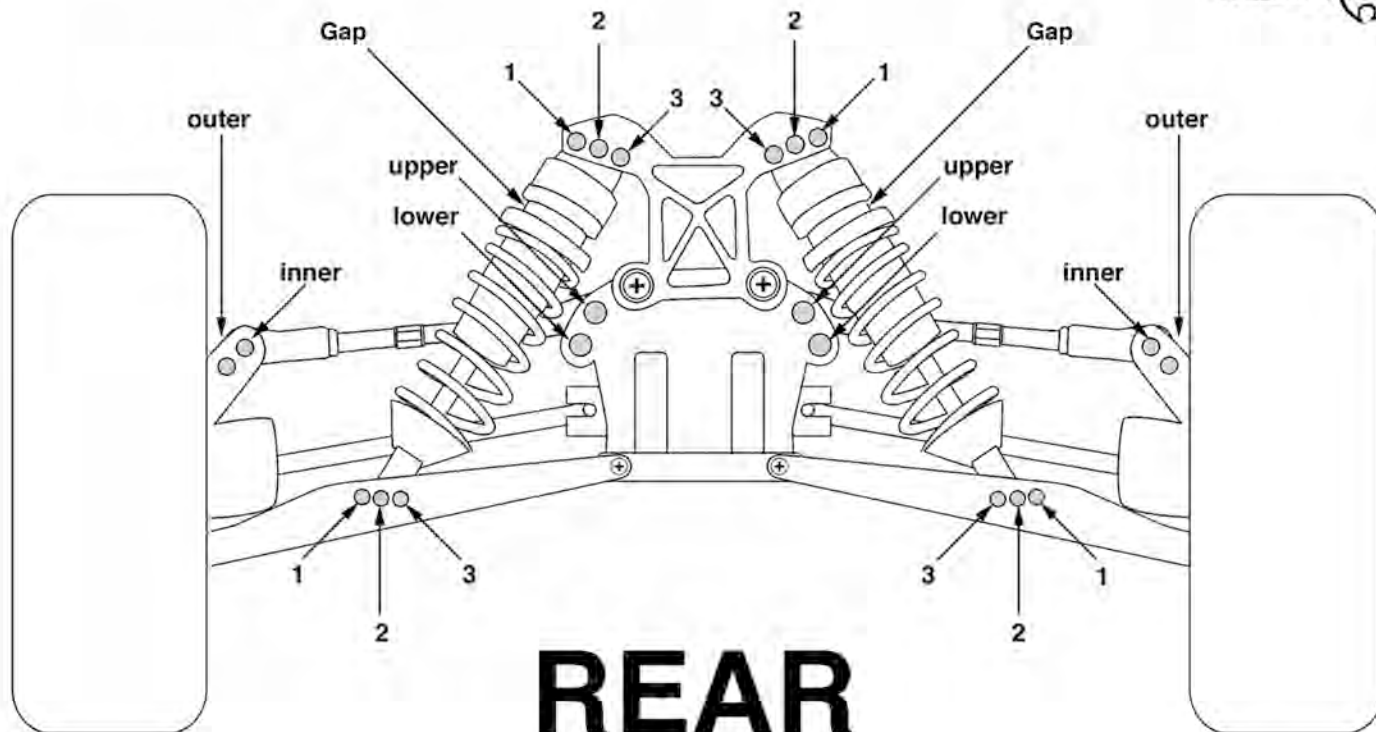

**Shock Position:**

Top: 1  2  3   
 Bottom: 1  2  3

**Upper Link Position:**

Inside: Upper  Lower   
 Outside: Inner  Outer

Shock oil: \_\_\_\_\_ wt.

Camber Deg:

Negative: \_\_\_\_\_ degrees  
 Positive: \_\_\_\_\_ degrees

Spring pre-load "Gap": \_\_\_\_\_ in.

Ride Height Front: \_\_\_\_\_ in.

Toe:

In: \_\_\_\_\_ degrees  
 Out: \_\_\_\_\_ degrees

Piston inserts: \_\_\_\_\_ (1, 2, or 3 holes)

Gas:

Octane: \_\_\_\_\_  
 2-stroke oil content: \_\_\_\_\_%

Pinion Gear: \_\_\_\_\_ teeth

Spark Plug:

Gap: \_\_\_\_\_  
 Brand: \_\_\_\_\_

Spur Gear: \_\_\_\_\_ teeth

Spur Gear: metal  plastic

Rear Diff Oil: \_\_\_\_\_ wt.

Tires: \_\_\_\_\_  
 Inserts: \_\_\_\_\_

# PERFORMANCE UPGRADES

Redcat Racing offers many parts upgrade options that are geared toward hardcore performance. Performance that makes your hair stand on end and your blood boil. Hardcore Redcat performance! Performance that allows you to blast around the back yard or track while leaving everyone else in the dust! Performance that allows you to take that big jump you USED TO break parts on! I'm talking about aluminum! Redcat offers many aluminum performance upgrades that not only add durability, but precision. The kind of precision, and added tune ability, impossible to achieve with stock plastic parts. I'm talking hardcore performance aluminum upgrades.

To see which performance upgrades are available for your model, go to: [www.redcatracing.com](http://www.redcatracing.com)

Website



Scan the QR code with your smart phone to go directly to our website: [www.redcatracing.com](http://www.redcatracing.com)

To see what others are doing with their Redcat Racing vehicles, check out our Facebook page and Blog site.

Facebook



Scan the QR code with your smart phone to go directly to our Facebook: [www.facebook.com/RedcatRacing](http://www.facebook.com/RedcatRacing)

Blog



Scan the QR code with your smart phone to go directly to our Blog site: [www.redcatrc.com](http://www.redcatrc.com)





***REDCAT***

[www.redcatracing.com](http://www.redcatracing.com)

MAN-GAS-2020.06.11-V14

To ensure that you are using the most recent version of this manual:  
[www.redcatracing.com/manuals/GAS-MANUAL.pdf](http://www.redcatracing.com/manuals/GAS-MANUAL.pdf)