

MODEL: FOSSA SCT



FOSSA SCT



FAST™ AFFORDABLE™ FUN™

MAN-FOSSASCT-2018.8.16

- To ensure that you are using the most recent version of this manual:
www.redcatracing.com/manuals/FOSSASCTMANUAL.pdf
- To ensure that you have the most recent version of the Electronic Vehicles Manual:
www.redcatracing.com/manuals/ELECTRIC-MANUAL.pdf

WARNINGS

READ ALL INSTRUCTIONS INCLUDED WITH VEHICLE BEFORE OPERATING



AGE WARNING!

This radio controlled (RC) vehicle is not a toy! You must be 14 years of age or older to operate this vehicle. Adult supervision is required.



RISK OF RUNAWAY VEHICLE OR INJURY!

Never turn on the vehicle or plug in the battery pack without first having the controller turned on.



RISK OF FIRE! / RISK OF EXPLOSION!

There is a risk of fire and explosion when dealing with batteries. Rechargeable batteries may become hot and catch fire if left unattended or charged too quickly. Use extra caution when charging LiPO batteries. Use only LiPO specific chargers with LIPO batteries. Use a LiPO safe charging pouch when charging LiPOs. Charge away from flammable materials. Never charge at a rate higher than 1C. {2000Mah pack= 2amps charge rate}. Overcharging can lead to fire and explosion. Always store battery packs in a cool dry place.



RISK OF BURNS!

The batteries, electronic speed controller (ESC), electric motor, and other areas of the vehicle can get hot. Burns can occur if touched after vehicle operation. Allow adequate time to cool before handling.



RISK OF ELECTRICAL SHOCK!

Use caution when charging batteries. Do not touch positive and negative leads together. Do not lay battery on metal. Use only chargers specified for the battery type being charged. Keep batteries and chargers away from water.



RISK OF INJURY!

Hobby grade RC vehicles can cause serious injury or death if not operated correctly. Never use vehicle in crowds. Never chase people or animals. Drive in safe open areas only. Keep body parts away from moving parts.



RISK OF DAMAGE!

Never operate RC vehicles on public roads. Damage of vehicle and property can occur. Only operate on open private property. Never charge the battery pack while it is still plugged into the RC vehicle. Always unplug the battery pack from the electronic speed controller (ESC) and remove the battery from the RC vehicle before charging. Failure to do so will result in damage to the vehicle's electronics.



WARNING!

Do not mix old and new batteries. Do not mix alkaline, lithium, standard (carbon zinc), or rechargeable (nickel cadmium) batteries. Do not change or charge batteries in a hazardous location.



FCC Compliance Statement! The radio included with your vehicle complies with part 15 of the FCC Rules. Operation is subject to the following two conditions: (1) This device may not cause harmful interference, and (2) This device must accept any interference received, including interference that may cause undesired operations. Note: This equipment has been tested and found to comply with the limits for a Class B digital device, pursuant to Part 15 of the FCC Rules. These limits are designed to provide reasonable protection against harmful interference in a residential installation. This equipment generates, uses and can radiate radio frequency energy and, if not installed and used in accordance with the instructions, may cause harmful interference to radio communications. However, there is no guarantee that interference will not occur in a particular installation. If this equipment does cause harmful interference to radio or television reception, which can be determined by turning the equipment off and on, the user is encouraged to try to correct the interference by one of the following measures:

Reorient or relocate the receiving antenna.

Increase the separation between the equipment and receiver.

Connect the equipment into an outlet on a circuit different from that to which the receiver is connected.

Consult the dealer or an experienced radio/TV technician for help.

WARNING: Any changes or modifications not expressly approved by the party responsible for compliance could void the user's authority to operate this equipment.

WARNING: While operating the Radio, a separation distance of at least 20 centimeters must be maintained between the radiating antenna and the body of the user or nearby persons in order to meet the FCC RF exposure guidelines.

WARNINGS

ENGLISH

WARNING: DO NOT MIX OLD AND NEW BATTERIES. DO NOT MIX ALKALINE, LITHIUM, STANDARD (CARBON ZINC), OR RECHARGEABLE (NICKEL CADMIUM) BATTERIES.

WARNING: THIS REMOTE-CONTROL VEHICLE IS NOT A TOY. THIS REDCAT RACING PRODUCT IS A HIGH-PERFORMANCE VEHICLE THAT FOR SAFETY REASONS SHOULD NOT BE RUN ON PUBLIC STREETS, IN CROWDED AREAS, ENVIRONMENTALLY SENSITIVE AREAS, OR NEAR CHILDREN OR ANIMALS. THIS VEHICLE CONTAINS MOVING PARTS AND PARTS THAT CAN BECOME HOT TO THE TOUCH DURING NORMAL OPERATIONS. PLEASE READ THE MANUAL AND ALL WARNINGS CAREFULLY TO AVOID ANY DAMAGE OR INJURIES THAT MIGHT OCCUR. FOLLOW ALL PRODUCT WARNINGS. THIS PRODUCT MAY REQUIRE SOME ASSEMBLY AND ROUTINE MAINTENANCE IS NECESSARY. VISIT REDCATRACING.COM FOR HELPFUL VIDEOS ON PREPARING AND RUNNING YOUR R/C CAR. PLEASE GO TO REDCATRACING.COM TO VIEW THE LIMITED WARRANTY INFORMATION. CRASH DAMAGE IS NOT COVERED UNDER WARRANTY.

WARNING: THIS PRODUCT CONTAINS CHEMICALS WHICH ARE KNOWN TO THE STATE OF CALIFORNIA TO CAUSE CANCER, BIRTH DEFECTS, OR OTHER REPRODUCTIVE HARM. NOT FOR CHILDREN UNDER 14 YEARS OF AGE WITHOUT ADULT SUPERVISION. CONTAINS SMALL PARTS. KEEP OUT OF REACH OF SMALL CHILDREN.

MADE IN CHINA

GERMAN

WARNUNG: ALTE UND NEUE BATTERIEN NICHT MISCHEN. MISCHEN SIE KEINE ALKALI-, LITHIUM-, STANDARD-(KOHLENSTOFF-ZINK) ODER WIEDERAUFLADBAREN (NICKEL-CADMIUM) BATTERIEN.

WARNUNG: DIESES FERNGESTEUERTE FAHRZEUG IST KEIN SPIELZEUG. DIESES REDCAT RACING PRODUKT IST EIN HOCHLEISTUNGSFAHRZEUG, DAS AUS SICHERHEITSGRÜNDEN NICHT AUF ÖFFENTLICHEN STRAßEN, IN ÜBERFÜLLTEN GEBIETEN, IN ÖKOLOGISCH SENSIBLEN BEREICHEN ODER IN DER NÄHE VON KINDERN ODER TIEREN EINGESETZT WERDEN SOLLTE. DIESES FAHRZEUG ENTHÄLT BEWEGLICHE TEILE UND TEILE, DIE SICH WÄHREND DES NORMALEN BETRIEBS ERHITZEN KÖNNEN. BITTE LESEN SIE DAS HANDBUCH UND ALLE WARNHINWEISE SORGFÄLTIG DURCH, UM SCHÄDEN ODER VERLETZUNGEN ZU VERMEIDEN. ALLE PRODUKTWARNUNGEN BEACHTEN. DIESES PRODUKT KANN EINIGE MONTAGE- UND WARTUNGSARBEITEN ERFORDERN. BESUCHEN SIE REDCATRACING.COM FÜR HILFREICHE VIDEOS ÜBER DIE VORBEREITUNG UND DEN BETRIEB IHRES RC-AUTOS. BITTE GEHEN SIE ZU REDCATRACING.COM, UM DIE INFORMATIONEN ZUR EINGESCHRÄNKTEN GARANTIE EINZUSEHEN. UNFALLSCHÄDEN SIND VON DER GARANTIE AUSGESCHLOSSEN.

WARNUNG: DIESES PRODUKT ENTHÄLT CHEMIKALIEN, DIE DEM STAAT KALIFORNIEN BEKANNT SIND, UM KREBS, GEBURTSFEHLER ODER ANDERE REPRODUKTIVE SCHÄDEN ZU VERURSACHEN. BENUTZUNG NICHT FÜR KINDER UNTER 14 JAHREN OHNE AUFSICHT EINES ERWACHSENEN. ENTHÄLT KLEINTEILE. AUßERHALB DER REICHWEITE VON KLEINEN KINDERN AUFBEWAHREN.

HERGESTELLT IN CHINA

SPANISH

ADVERTENCIA: NO REVOLVER BATERIAS VIEJAS CON NUEVAS. NO REVUELVA ALCALINAS, LITIO, ESTANDARS (CARBONO DE ZINC), O BATERIAS RECARGABLES (NIQUEL CADMIO).

ADVERTENCIA: ESTE VEHICULO CONTROL REMOTO NO ES UN JUGETE. ESTE PRODUCTO REDCAT RACING ES UN VEHICULO DE ALTO RENDIMIENTO Y POR RAZONES DE SEGURIDAD NO DEVERIA SER CORRIDO EN CALLES PUBLICAS, EN ZONAS CON MUCHEDUMBRE, AREAS AMBIENTALMENTE SENSIBLES, O CERCA DE NIÑOS O ANIMALES. ESTE VEHICULO CONTIENE PARTES QUE TIENEN MOVIMIENTO Y PARTES QUE SE CALIENTAN DURANTE SU USO NORMAL. POR FAVOR LEA EL MANUAL Y TODAS SUS ADVERTENCIAS CUIDADOSAMENTE PARA EVITAR CUALQUIER DAÑO O LESION QUE PUEDA OCURRIR. SIGA TODAS LAS ADVERTENCIAS DEL PRODUCTO. ESTE PRODUCTO PUEDE REQUERIR ALGUN ENSAMBLE Y ES NECESARIO EL MANTENIMIENTO DE RUTINA. VISITA REDCATRACING.COM POR VIDEOS DE AYUDA EN PREPARACION Y COMO CORRER TU R/C CAR. POR FAVOR VE A REDCATRACING.COM PARA VER LA INFORMACION DE LOS LIMITES DE GARANTIA. DAÑOS POR CHOQUE NO SON CUBIERTOS POR LA GARANTIA.

ADVERTENCIA: DEACUERDO AL ESTADO DE CALIFORNIA ESTE PRODUCTO CONTIENE QUIMICOS QUE SON CONOCIDOS POR CAUSAR CANCER, DEFECTOS DE NACIMIENTO, O OTROS DAÑOS REPRODUCTIVOS. NO PARA NIÑOS MENORES DE 14 AÑOS DE EDAD SIN LA SUPERVISION DE UN ADULTO. CONTIENE PARTES PEQUEÑAS, MANTENLO FUERA DEL ALCANCE DE LOS NIÑOS PEQUEÑOS.

HECHO EN CHINA

FRENCH

AVERTISSEMENT : NE PAS MÉLANGER D'ANCIENNES ET DE NOUVELLES PILES. NE PAS MÉLANGER DES PILES ALCALINES, AU LITHIUM, STANDARD (CARBONE-ZINC) OU RECHARGEABLES (NICKEL-CADMIUM).

AVERTISSEMENT : CE VÉHICULE TÉLÉCOMMANDÉ N'EST PAS UN JOUET. CE PRODUIT REDCAT RACING EST UN VÉHICULE DE HAUTE PERFORMANCE QUI, POUR DES RAISONS DE SÉCURITÉ, NE DOIT PAS ÊTRE UTILISÉ SUR LA VOIE PUBLIQUE, DANS DES ENDROITS BONDÉS, DANS DES ZONES ÉCOLOGIQUEMENT SENSIBLES OU À PROXIMITÉ D'ENFANTS OU D'ANIMAUX. CE VÉHICULE CONTIENT DES PIÈCES MOBILES ET DES PIÈCES QUI PEUVENT DEVENIR CHAUDES AU TOUCHER PENDANT LES OPÉRATIONS NORMALES. VEUILLEZ LIRE ATTENTIVEMENT LE MANUEL ET TOUS LES AVERTISSEMENTS AFIN D'ÉVITER TOUT ACCIDENT OU BLESSURE QUI POURRAIT S'EN SUIVRE. SUIVRE TOUTES LES MISES EN GARDE SUR LES PRODUITS. CE PRODUIT PEUT NÉCESSITER UN CERTAIN ASSEMBLAGE ET UN ENTRETIEN DE ROUTINE SI NÉCESSAIRE. VISITEZ REDCATRACING.COM POUR VISIONNER DES VIDÉOS UTILES SUR LA PRÉPARATION ET L'UTILISATION DE VOTRE VOITURE DE LOCATION. VEUILLEZ VOUS RENDRE SUR REDCATRACING.COM POUR CONSULTER LES INFORMATIONS SUR LA GARANTIE LIMITÉE. LES DOMMAGES DUS À UN ACCIDENT NE SONT PAS COUVERTS PAR LA GARANTIE.

AVERTISSEMENT : CE PRODUIT CONTIENT DES PRODUITS CHIMIQUES QUI SONT CONNUS DE L'ÉTAT DE CALIFORNIE COMME CAUSANT LE CANCER, DES MALFORMATIONS CONGÉNITALES OU D'AUTRES PROBLÈMES DE REPRODUCTION. PAS POUR LES ENFANTS DE MOINS DE 14 ANS SANS LA SURVEILLANCE D'UN ADULTE. CONTIENT DE PETITES PIÈCES. GARDER HORS DE PORTÉE DES JEUNES ENFANTS.

FABRIQUÉ EN CHINE

FEATURES & SPECIFICATIONS

- Brushed Electric RC540 Motor
- Waterproof Brushed 2-IN-1 ESC/Receiver
- Forward & Reverse
- 2 Wheel Drive
- Oil Filled Shocks
- 2.4GHz Radio System
- Includes a 7.2V 2000mAh NiMH Battery
- Includes a 1A NiMH Charger

- Scale: 1:10
- Length: 501mm
- Width: 292mm
- Height: 190mm
- Weight: 1,542g
- Steering Servo: 3kg Waterproof

Maximum Battery Capabilities:

Maximum NiMH Battery: 7.2v 5800mAh NiMH
Maximum LIPO Battery: 7.4v 2S 5000mAh 20C

WARNING: If using a LIPO battery, never charge a LIPO battery with a NIMH Charger, as it can cause fire or explosion. Only use an approved LIPO charger when charging LIPO batteries. Using a LIPO battery with the FOSSA SCT requires the correct setting on the ESC (Electronic Speed Controller) See image.



The ESC is set up to use NIMH batteries ONLY. To use a LIPO battery, you must move the small plastic plug into the LIPO position as the image shows.

WARNING: Exceeding the maximum battery voltage may cause damage to the motor and electronic components of this vehicle and will void the vehicle warranty.

VEHICLE OVERVIEW

- A:** On/Off Switch
- B:** 2-in-1 Receiver/ESC
- C:** Steering Servo
- D:** Electric Motor
- E:** Battery
- F:** Battery Release

- G:** Battery Connector
- H:** Oil Filled Shock (x4)
- I:** Adjustable Steering Link (x2)
- J:** Adjustable Upper Suspension Link (x4)
- K:** Motor Connectors

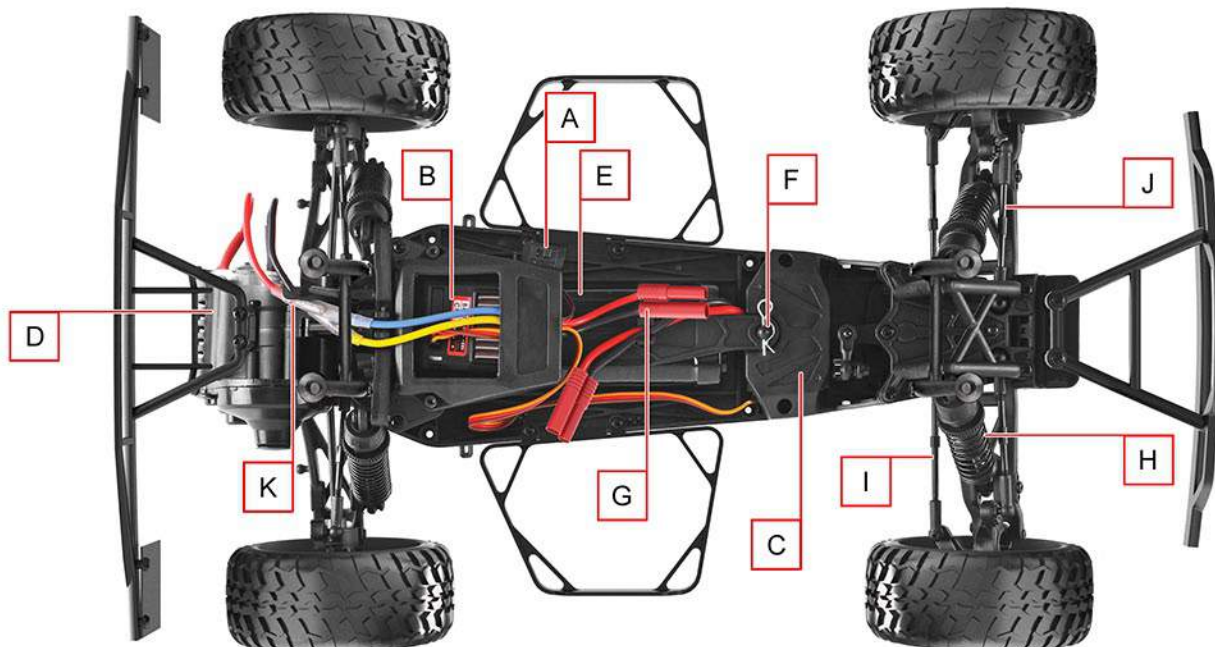

RADIO GUIDE

RADIO:

On/Off Switch: Switch that turns the transmitter On and Off.

Power LED: Left LED light. Lights up when the transmitter is turned on.

Steering Wheel: Rotate counter-clockwise to steer the vehicle left. Rotate clockwise to steer the vehicle right.

Throttle Trigger: Pull to go forward. Push to apply brakes, push again to go reverse.

Steering Reverse Switch: Top left switch. Used to change steering orientation. If the car turns right when you steer left, flip this switch.

Steering Trim: Left knob. Used to set the steering neutral point. If the vehicle veers in one direction while the steering wheel is centered, turn this knob in the opposite direction until the car drives straight.

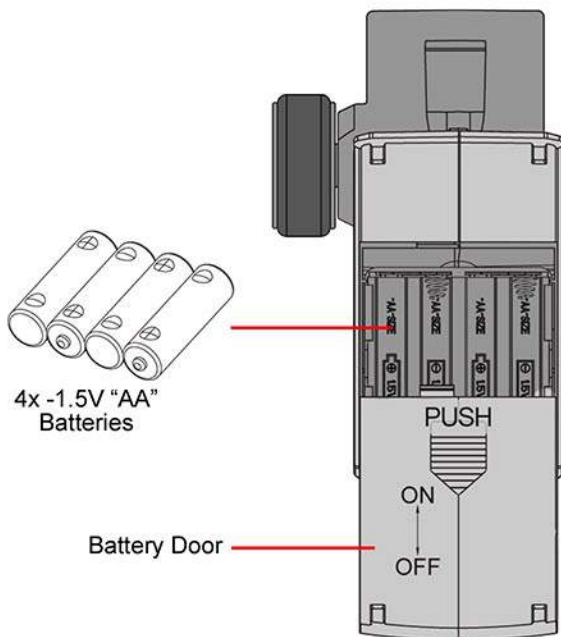

INSTALLING BATTERIES:

This radio uses 4x 1.5V "AA" batteries that must be installed into the bottom of the handle.

1. Turn the radio over so you are looking at the base (bottom) of the handle. See figure to the left.
2. Push on the battery door, where it says push, and slide the door towards the rear of the radio as shown.
3. Install 4x "AA" batteries, lining up (+) and (-) sides of the battery with the (+) and (-) marks in the battery compartment. The flat (-) side of the battery will go against the spring.
4. Reinstall the battery door.

WARNING: Do not mix old and new batteries. Do not mix alkaline, lithium, standard (carbon zinc), or rechargeable (nickel cadmium) batteries. Do not change or charge batteries in a hazardous location. Only use new AA batteries in your radio transmitter. Replace the transmitter batteries often to ensure full control of the vehicle.

RADIO GUIDE

TURNING ON THE RADIO:

The radio needs to calibrate every time it is turned on. Failure to do so may result in loss of vehicle, injury, and/or damage. The radio will calibrate automatically, but you need to be sure to follow these three simple steps every time you turn on the radio and/or the vehicle.

Three Simple Steps:



Stand up the radio on a flat surface, away from obstructions. Be sure the throttle trigger is free from obstructions and is in the neutral (center) resting position. Do not touch or move the trigger in any way, and turn on the radio.



Be sure the throttle trigger remains free from obstructions and stays in the neutral (center) resting position for at least three (3) seconds before turning on the vehicle. You do not need to touch the radio for this. During this time, the radio is automatically calibrating and should not be touched.

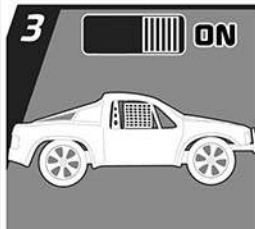

After three (3) seconds have passed, you may turn on the vehicle. At this point, the radio and vehicle are ready to use.

USING MULTIPLE VEHICLES:

If using more than one vehicle, you need to follow the “Three Simple Steps” above for each vehicle, one vehicle at a time, allowing each vehicle to sync with its radio, one at a time. Be sure to leave a few seconds time between the powering on sequence for each vehicle. Trying to power on more than one vehicle at a time will not allow each vehicle to properly connect with its radio, this will result in a loss of control.

TURNING OFF THE RADIO:

Two Simple Steps:

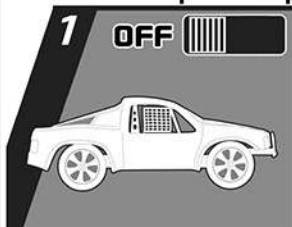

Before turning off the radio, you must first turn off the vehicle.



After the vehicle has been turned off, you may turn off the radio.

Attention: Never turn on the vehicle without first turning on the radio, by following the three simple steps above. The radio **MUST** be on whenever the vehicle is powered on. Always unplug the battery if you plan on leaving the vehicle turned off for any extended length of time.

CHARGING THE NIMH BATTERY

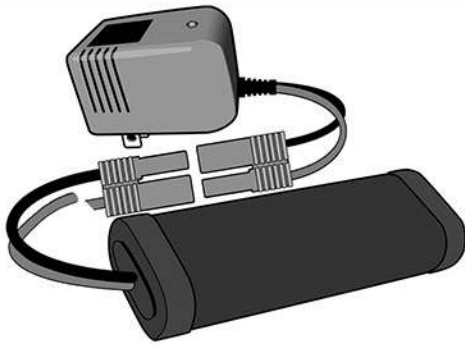

ATTENTION

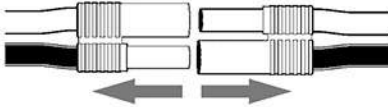

Before attempting to charge your NiMH battery, be sure to remove it from the vehicle and place it on a nonflammable surface away from hazards, such as curtains, couches, or clothing.

Warning! Batteries can potentially catch fire if over charged or charged incorrectly.

NIMH Charging:

Charging NiMH battery packs with the included charger is simple.

1. Unplug and remove the battery from the RC vehicle.
2. Plug the charger into a 110v wall receptacle.
3. Plug the battery pack into the charger.

When plugging the battery into the charger, ensure the red (POS+) wire on the battery is connected to the red (POS+) wire of the charger. Also ensure the black (NEG-) wire on the battery is connected to the black (NEG-) wire of the charger.

Charge times vary according to charger current and battery mAh. **Battery mAh ÷ Charger mA = Approximate charge time**

Ex. 2000mAh battery ÷ 500 mA charger = ~4 hours charge time.

BATTERY CHARGER	2000mAh	2200mAh	3000mAh	3800mAh
250mA	8 hrs	8.8 hrs	12 hrs	15.2 hrs
500mA	4 hrs	4.4 hrs	6 hrs	7.6 hrs
1A	2 hrs	2.2 hrs	3 hrs	3.8 hrs

ATTENTION

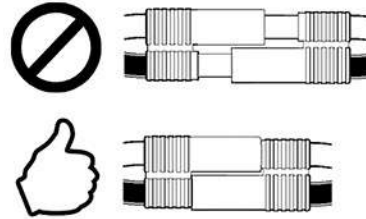

BATTERY CONNECTION INSTRUCTIONS:
Make sure battery connectors are fully pushed in when charging and connecting to the vehicle.

ATTENTION

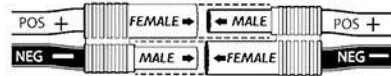

Be sure the wires are correctly orientated when plugging the battery into the vehicle.

When plugging the battery into the vehicle, Ensure the red (POS+) wire on the battery is connected to the red (POS+) wire of the ESC. Also ensure the black (NEG-) wire on the battery is connected to the black (NEG-) wire of the ESC.

Improper connection may damage electronics.

STOP

WARNING

STOP

UNPLUG THE BATTERY PACK FROM THE VEHICLE!

BEFORE CHARGING YOUR BATTERY PACK, YOU MUST FIRST UNPLUG IT FROM THE ESC. FAILURE TO UNPLUG THE BATTERY FROM THE VEHICLE'S ESC BEFORE CHARGING MAY PERMANENTLY DAMAGE SOME OR ALL ELECTRONICS IN THE VEHICLE.

NEVER LEAVE BATTERY PACKS UNATTENDED WHILE CHARGING! Leaving a battery unattended while charging may result in fire and damage / injury.

NEVER ALLOW A BATTERY PACK TO GET HOT! It's normal for the battery pack to get warm, but it should never get hot! Monitor batteries during charging and unplug to let cool if the battery gets hot.

WHEN CHARGING LIPOs, A LIPO SAFE CHARGING BAG SHOULD BE USED TO HELP PREVENT FIRES.



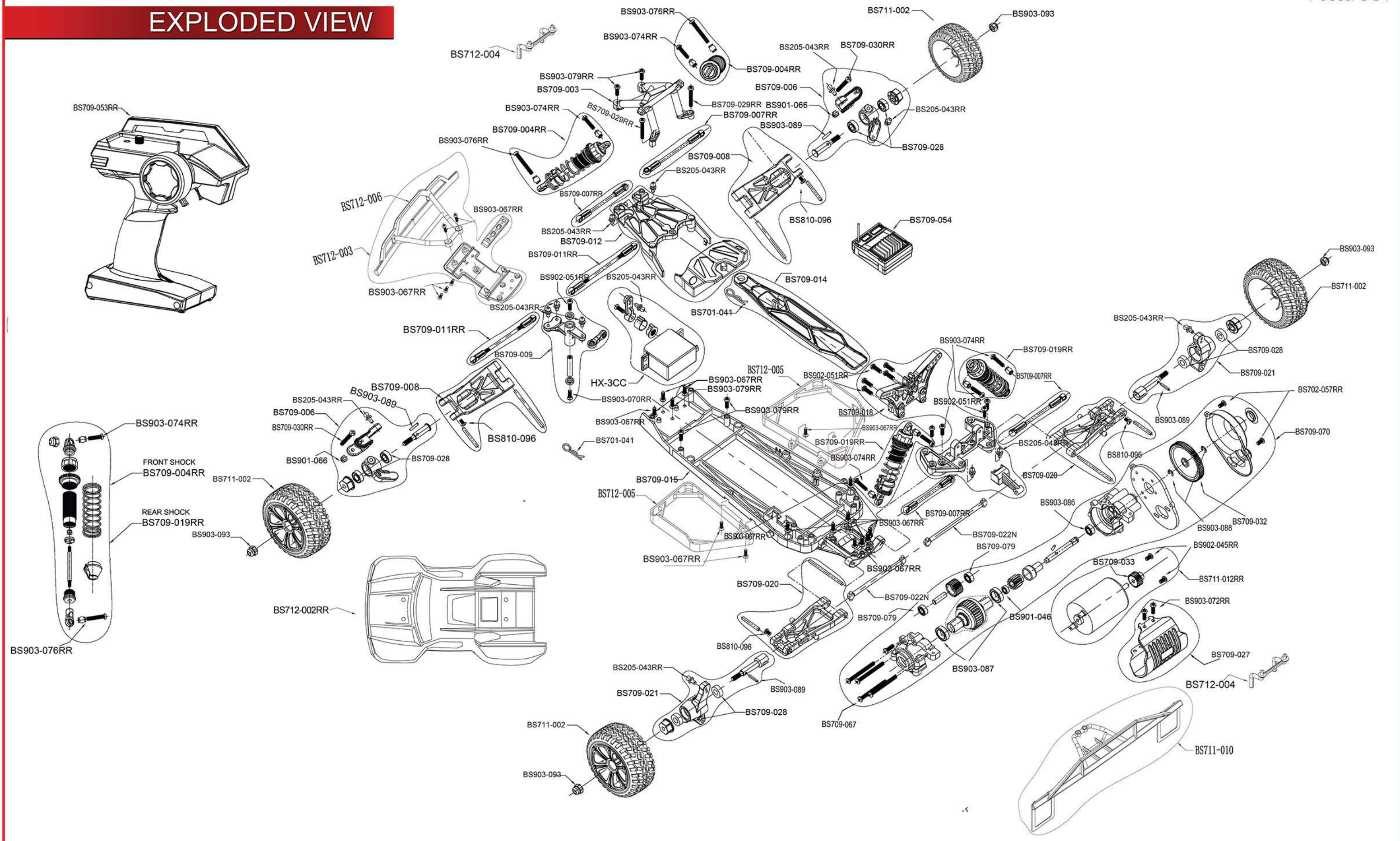







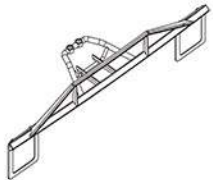
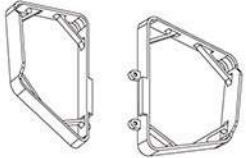
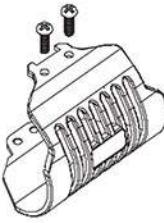
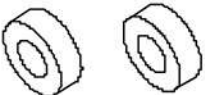

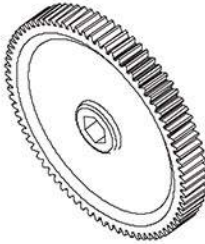

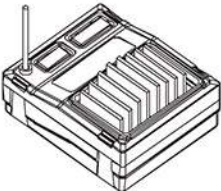
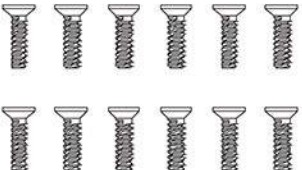

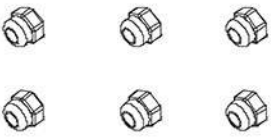
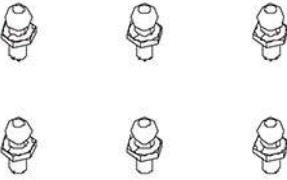

EXPLODED VIEW





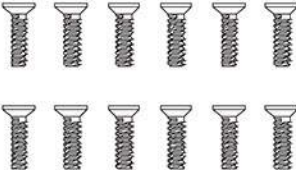



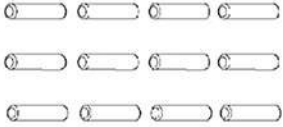

PARTS IDENTIFICATION

<p>BS711-002 - Assembled wheel / tire</p> 	<p>BS712-004 - Body post (F/R)</p> 	<p>BS709-003 - Front shock tower</p> 	<p>BS709-004RR - Front shock absorber (2x)</p> 
<p>BS712-003 - Bumper assembly (front)</p> 	<p>BS709-006 - Steering knuckle unit (left/right)</p> 	<p>BS709-007RR - Upper susp. link</p> 	<p>BS709-008 - Susp. arm (front) (left/right)</p> 
<p>BS709-009 - Servo bellcrank</p> 	<p>HX-3CC - Servo w/ servo saver</p> 	<p>BS709-011RR - Steering link</p> 	<p>BS709-012 - Front upper deck</p> 
<p>BS709-013 - 20T Pinion gear</p> 	<p>BS709-014 - Battery cover</p> 	<p>BS709-015 - Chassis</p> 	<p>BS712-002RR - Body</p> 
<p>BS712-006 - Front bumper</p> 	<p>BS709-018 - Rear shock tower & brace</p> 	<p>BS709-019RR - Shock absorber (rear) (2x)</p> 	<p>BS709-020 - Susp. arm (rear) (left/right)</p> 
<p>BS709-021 - Hub carrier unit (rear) (2x)</p> 	<p>BS709-022N - Dog bone drive shaft (2x)</p> 	<p>BS709-070 - Gear box unit</p> 	<p>BS711-012RR - Motor w/20T pinion gear</p> 

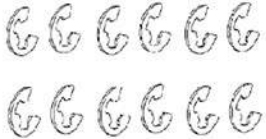
PARTS IDENTIFICATION

<p>BS711-010 - Rear bumper</p> 	<p>BS712-005 - Side guards</p> 	<p>BS709-027 - Motor guard set</p> 	<p>BS903-014 - Oil bearing</p> 
<p>BS709-029RR - BM3*25mm cross screw</p> 	<p>BS709-030RR - BM3*30mm cross screw</p> 	<p>BS709-032 - Spur gear</p> 	<p>BS709-053RR - Transmitter</p> 
<p>BS709-054 - Receiver/ESC 2-in-one</p> 	<p>BS903-067RR - TPF3*10mm cross screw</p> 	<p>BS903-079RR - BM3*10mm cross screw</p> 	<p>BS903-093 - M4 Nylon lock-nut</p> 
<p>BS205-043RR - Screw 4.7*12 (Ball stud)</p> 	<p>BS701-041 - 6# Body clip</p> 	<p>BS903-076RR - BT3*20mm cross screw</p> 	<p>BS903-074RR - BT3*14mm cross screw</p> 
<p>BS702-057RR - BM3*6mm cross screw</p> 	<p>BS902-045RR - BM3*8mm cross screw</p> 	<p>BS902-051RR - BT3*10mm cross screw</p> 	<p>BS901-066 - M3 locknut</p> 
<p>BS903-070RR - ISO3*10mm cross screw</p> 	<p>OPTIONAL CHARGER HX-N802 - 2A NIMH fast charger</p> 	<p>OPTIONAL BATTERY HX-3800MH-B - Hexfly 3800 mAh 7.2V NIMH Rechargeable Battery</p> 	<p>OPTIONAL BATTERY HX-5000MH-B - Hexfly 5000 mAh 7.2V NIMH Rechargeable Battery</p> 

PARTS IDENTIFICATION

<p>BS903-089 - PIN 2*9.5 (12pcs)</p> 	<p>BS903-072RR - BT 3*8 (12pcs)</p> 	<p>BS903-086 - Ball bearing 5*10*4 (2pcs)</p> 	<p>BS903-088 - E-Clip (12pcs)</p> 
<p>BS903-087 - Ball bearing 12*18*4 (2pcs)</p> 	<p>BS709-079 - Ball bearing 5*8*2.5 (2pcs)</p> 	<p>BS901-046 - Ball bearing 4*8*3</p> 	<p>BS709-067 - Cylinder head hex screws HM3*35</p> 
<p>BS810-096 - Meson head machine screw PWB 2.5*6*4.8</p> 			

HAVING A PROBLEM?

Radio is acting funny? Trouble charging your battery? Lost a part?
Can't get the wheels back on correctly? Just plain frustrated?
Want to tell us how great you think Redcat Racing is?



**Before you head back to the store
drop us a line, we would love to help!**



Send us an Email @:
support@redcatracing.com

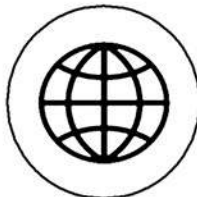

Fill out a support warranty form @:
<http://www.redcatracing.com/Warranty-Claim-Form>



Give us a Call @:
602-454-6445 Option # 2



WWW.REDCATRACING.COM

WARRANTY INFO

This product carries a 90 day limited warranty.

If you have any questions, issues, or concerns about this product, please visit the support section of the Redcat Racing website.

Warranty Information:

<http://www.redcatracing.com/Warranty-Information>

Warranty Claim Form:

<http://www.redcatracing.com/Warranty-Claim-Form>

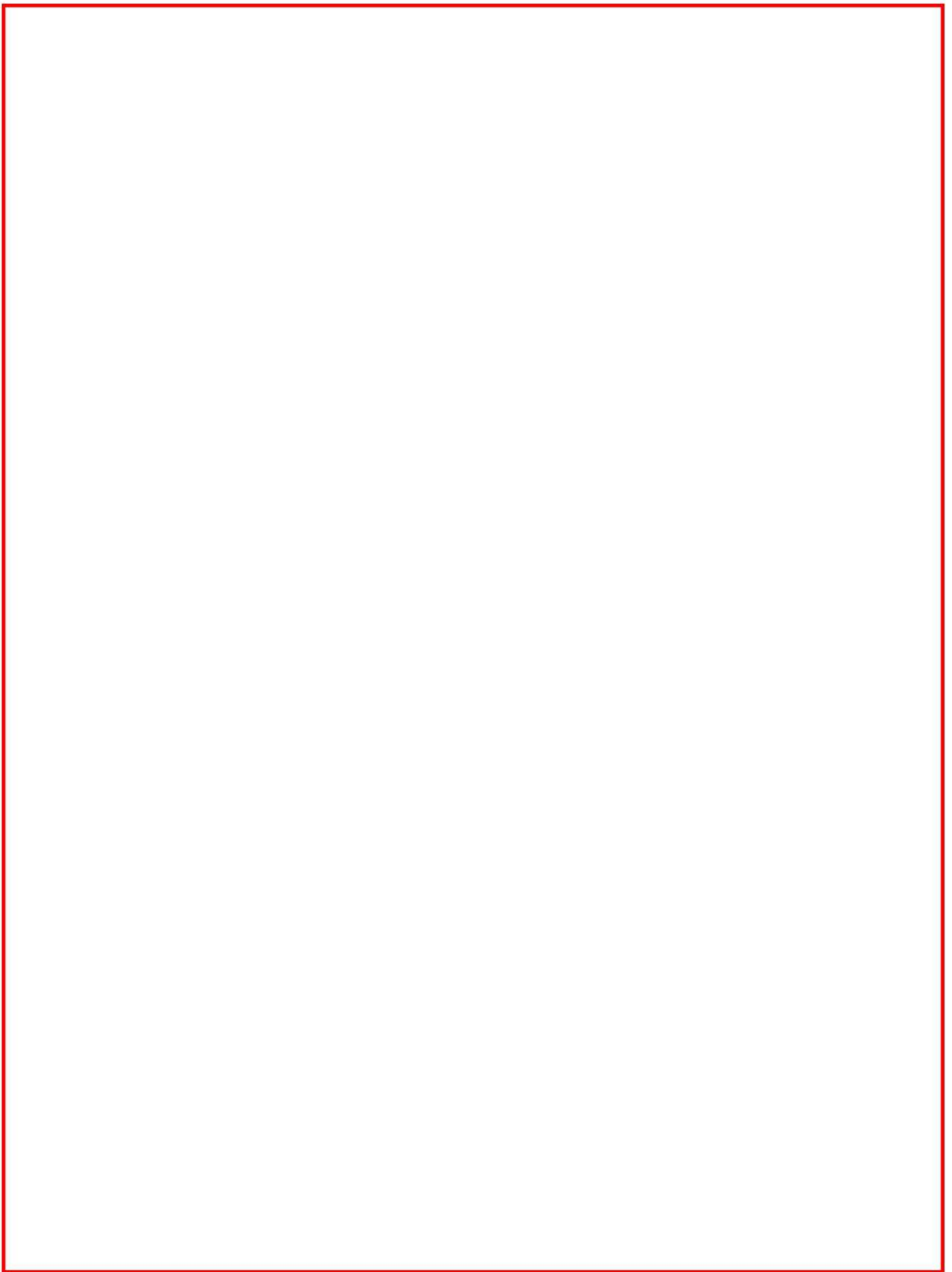



FAST AFFORDABLE FUN™

www.redcatracing.com

 Follow us on FaceBook: <https://www.facebook.com/RedcatRacing>

•To ensure that you are using the most recent version of this manual:
www.redcatracing.com/manuals/FOSSASCTMANUAL.pdf
•To ensure that you have the most recent version of the Electronic Vehicles Manual:
www.redcatracing.com/manuals/ELECTRIC-MANUAL.pdf