

MODEL: CYCLONE XB10



CYCLONE XB10



FAST™ AFFORDABLE™ FUN™

MAN-CYCLONEXB10-2018.8.24

- To ensure that you are using the most recent version of this manual:
www.redcatracing.com/manuals/CYCLONEXB10MANUAL.pdf
- To ensure that you have the most recent version of the Electronic Vehicles Manual:
www.redcatracing.com/manuals/ELECTRIC-MANUAL.pdf

WARNINGS

READ ALL INSTRUCTIONS INCLUDED WITH VEHICLE BEFORE OPERATING



AGE WARNING!

This radio controlled (RC) vehicle is not a toy! You must be 14 years of age or older to operate this vehicle. Adult supervision is required.



RISK OF RUNAWAY VEHICLE OR INJURY!

Never turn on the vehicle or plug in the battery pack without first having the controller turned on.



RISK OF FIRE! / RISK OF EXPLOSION!

There is a risk of fire and explosion when dealing with batteries. Rechargeable batteries may become hot and catch fire if left unattended or charged too quickly. Use extra caution when charging LiPO batteries. Use only LiPO specific chargers with LIPO batteries. Use a LiPO safe charging pouch when charging LiPOs. Charge away from flammable materials. Never charge at a rate higher than 1C. {2000Mah pack= 2amps charge rate}. Overcharging can lead to fire and explosion. Always store battery packs in a cool dry place.



RISK OF BURNS!

The batteries, electronic speed controller (ESC), electric motor, and other areas of the vehicle can get hot. Burns can occur if touched after vehicle operation. Allow adequate time to cool before handling.



RISK OF ELECTRICAL SHOCK!

Use caution when charging batteries. Do not touch positive and negative leads together. Do not lay battery on metal. Use only chargers specified for the battery type being charged. Keep batteries and chargers away from water.



RISK OF INJURY!

Hobby grade RC vehicles can cause serious injury or death if not operated correctly. Never use vehicle in crowds. Never chase people or animals. Drive in safe open areas only. Keep body parts away from moving parts.



RISK OF DAMAGE!

Never operate RC vehicles on public roads. Damage of vehicle and property can occur. Only operate on open private property. Never charge the battery pack while it is still plugged into the RC vehicle. Always unplug the battery pack from the electronic speed controller (ESC) and remove the battery from the RC vehicle before charging. Failure to do so will result in damage to the vehicle's electronics.



WARNING!

Do not mix old and new batteries. Do not mix alkaline, lithium, standard (carbon zinc), or rechargeable (nickel cadmium) batteries. Do not change or charge batteries in a hazardous location.



FCC Compliance Statement! The radio included with your vehicle complies with part 15 of the FCC Rules. Operation is subject to the following two conditions: (1) This device may not cause harmful interference, and (2) This device must accept any interference received, including interference that may cause undesired operations. Note: This equipment has been tested and found to comply with the limits for a Class B digital device, pursuant to Part 15 of the FCC Rules. These limits are designed to provide reasonable protection against harmful interference in a residential installation. This equipment generates, uses and can radiate radio frequency energy and, if not installed and used in accordance with the instructions, may cause harmful interference to radio communications. However, there is no guarantee that interference will not occur in a particular installation. If this equipment does cause harmful interference to radio or television reception, which can be determined by turning the equipment off and on, the user is encouraged to try to correct the interference by one of the following measures:

Reorient or relocate the receiving antenna.

Increase the separation between the equipment and receiver.

Connect the equipment into an outlet on a circuit different from that to which the receiver is connected.

Consult the dealer or an experienced radio/TV technician for help.

WARNING: Any changes or modifications not expressly approved by the party responsible for compliance could void the user's authority to operate this equipment.

WARNING: While operating the Radio, a separation distance of at least 20 centimeters must be maintained between the radiating antenna and the body of the user or nearby persons in order to meet the FCC RF exposure guidelines.

FEATURES & SPECIFICATIONS

- Brushed Electric RC540 Motor
- Waterproof Brushed 2-IN-1 ESC/Receiver
- Forward & Reverse
- 2 Wheel Drive
- Oil Filled Shocks
- 2.4GHz Radio System
- Includes (2x) 7.2V 2000mAh NiMH Batteries
- Includes 2A Fast Charger

- Scale: 1/10
- Length: 400mm
- Width: 280mm (260mm front, 280mm rear)
- Height: 125mm
- Steering Servo: 3Kg Waterproof

Maximum Battery Capabilities:

Maximum NiMH Battery: 7.2v 5800mAh NiMH
Maximum LIPO Battery: 7.4v 2S 5000mAh 20C

WARNING: This vehicle includes (2) NIMH battery packs. NEVER attempt to use both battery packs at the same time nor connect both packs together! Doing so may cause fire, damage, and/or injury. The second pack is intended as a spare. ONLY USE ONE BATTERY PACK AT A TIME! If using a LIPO battery, never charge a LIPO battery with a NIMH Charger, as it can cause fire or explosion. Only use an approved LIPO charger when charging LIPO batteries. Using a LIPO battery with the Cyclone XB10 requires the correct setting on the ESC (Electronic Speed Controller) See image.



The ESC is set up to use NIMH batteries ONLY. To use a LIPO battery, you must move the small plastic plug into the LIPO position as the image shows.

WARNING: Exceeding the maximum battery voltage may cause damage to the motor and electronic components of this vehicle and will void the vehicle warranty.

VEHICLE OVERVIEW

- A:** On/Off Switch
- B:** 2-in-1 Receiver/ESC
- C:** Steering Servo
- D:** Electric Motor
- E:** Battery
- F:** Battery Release

- G:** Battery Connector
- H:** Oil Filled Shock (x4)
- I:** Adjustable Steering Link (x2)
- J:** Adjustable Upper Suspension Link (x4)
- K:** Rear Body Post (x2)

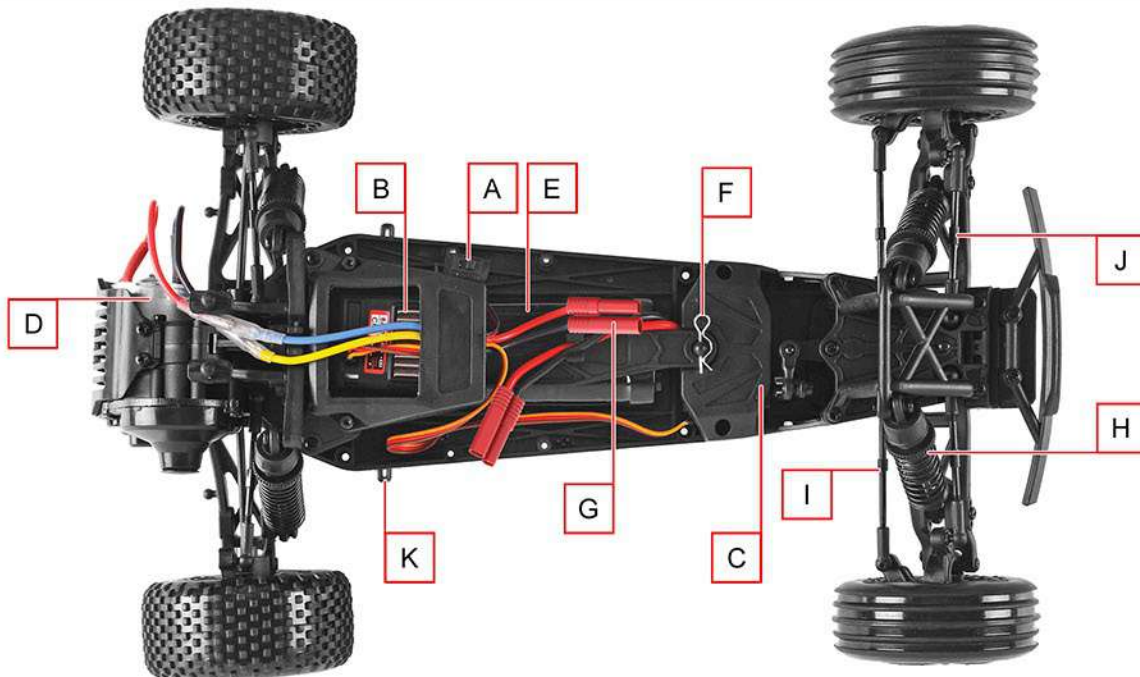

RADIO GUIDE

RADIO:

On/Off Switch: Switch that turns the transmitter On and Off.

Power LED: Left LED light. Lights up when the transmitter is turned on.

Steering Wheel: Rotate counter-clockwise to steer the vehicle left. Rotate clockwise to steer the vehicle right.

Throttle Trigger: Pull to go forward. Push to apply brakes, push again to go reverse.

Steering Reverse Switch: Top left switch. Used to change steering orientation. If the car turns right when you steer left, flip this switch.

Steering Trim: Left knob. Used to set the steering neutral point. If the vehicle veers in one direction while the steering wheel is centered, turn this knob in the opposite direction until the car drives straight.

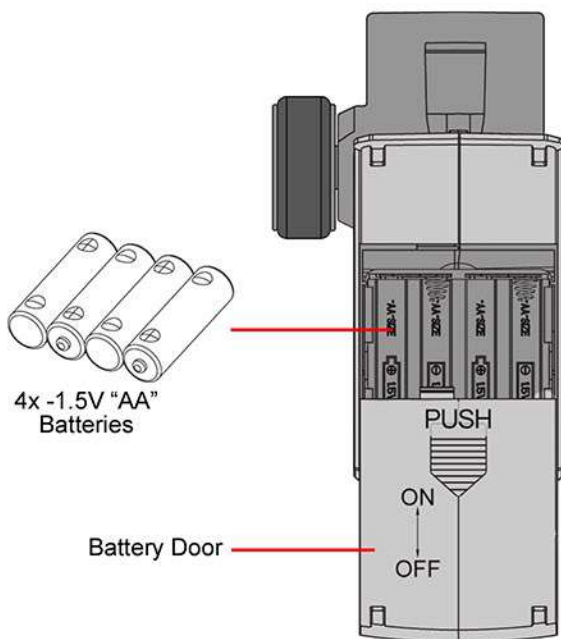

INSTALLING BATTERIES:

This radio uses 4x 1.5V "AA" batteries that must be installed into the bottom of the handle.

1. Turn the radio over so you are looking at the base (bottom) of the handle. See figure to the left.
2. Push on the battery door, where it says push, and slide the door towards the rear of the radio as shown.
3. Install 4x "AA" batteries, lining up (+) and (-) sides of the battery with the (+) and (-) marks in the battery compartment. The flat (-) side of the battery will go against the spring.
4. Reinstall the battery door.

WARNING: Do not mix old and new batteries. Do not mix alkaline, lithium, standard (carbon zinc), or rechargeable (nickel cadmium) batteries. Do not change or charge batteries in a hazardous location. Only use new AA batteries in your radio transmitter. Replace the transmitter batteries often to ensure full control of the vehicle.

RADIO GUIDE

TURNING ON THE RADIO:

The radio needs to calibrate every time it is turned on. Failure to do so may result in loss of vehicle, injury, and/or damage. The radio will calibrate automatically, but you need to be sure to follow these three simple steps every time you turn on the radio and/or the vehicle.

Three Simple Steps:



Stand up the radio on a flat surface, away from obstructions. Be sure the throttle trigger is free from obstructions and is in the neutral (center) resting position. Do not touch or move the trigger in any way, and turn on the radio.



Be sure the throttle trigger remains free from obstructions and stays in the neutral (center) resting position for at least three (3) seconds before turning on the vehicle. You do not need to touch the radio for this. During this time, the radio is automatically calibrating and should not be touched.

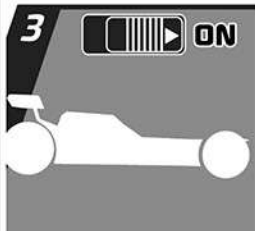

After three (3) seconds have passed, you may turn on the vehicle. At this point, the radio and vehicle are ready to use.

USING MULTIPLE VEHICLES:

If using more than 1 Cyclone XB10, you need to follow the “Three Simple Steps” for each vehicle, one vehicle at a time, allowing each vehicle to sync with its radio, one at a time. Be sure to leave a few seconds time between the powering on sequence for each vehicle. Trying to power on more than one vehicle at a time will not allow each vehicle to properly connect with its radio, this will result in a loss of control.

TURNING OFF THE RADIO:

Two Simple Steps:

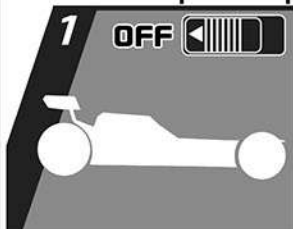

Before turning off the radio, you must first turn off the vehicle.



After the vehicle has been turned off, you may turn off the radio.

Attention: Never turn on the vehicle without first turning on the radio, by following the three simple steps above. The radio **MUST** be on whenever the vehicle is powered on. Always unplug the battery if you plan on leaving the vehicle turned off for any extended length of time.

CHARGING NIMH BATTERIES



ATTENTION: Before attempting to charge your NiMH battery, remove it from the vehicle and place it on a nonflammable surface away from hazards, such as curtains, couches, carpet, or clothing.

Warning! Batteries can potentially catch fire if over charged or charged incorrectly.

NIMH Charging:

1. Plug the charger into a 110V AC power supply, the power and status LEDs turn green.
2. Remove the 7.2V NiMH battery from the vehicle and plug into the charger.
3. Press the start/stop button. The status LED will turn red, this means the battery is charging. If the battery pack gets hot, press the start/stop button, unplug the battery, and let cool. Once cool, plug the battery into the charger and repeat steps 1-3.
4. The status LED will turn green when the battery pack is fully charged.
5. Unplug the battery pack from the charger.
6. Unplug the charger from the power supply.

When plugging the battery into the charger, ensure the red (POS+) wire on the battery is connected to the red (POS+) wire of the charger. Also ensure the black (NEG-) wire on the battery is connected to the black (NEG-) wire of the charger.

Charge times vary according to charger current and battery mAh. Battery mAh ÷ Charger mA = Approximate charge time.

Ex. 2000mAh battery ÷ included 2000mA (2A) charger = ~1 hour charge time.

Note: 2A = 2000mA

BATTERY CHARGER ↓	2000mAh	2200mAh	3000mAh	3800mAh
2 Amp	1 hr	1.1 hrs	1.5 hrs	1.9 hrs

ATTENTION

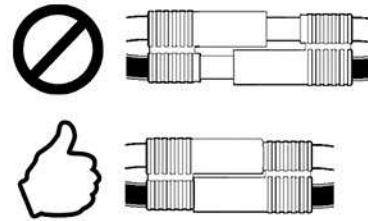

BATTERY CONNECTION INSTRUCTIONS:
Make sure battery connectors are fully pushed in when charging and connecting to the vehicle.

ATTENTION

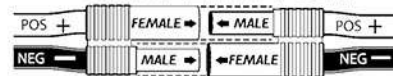

Be sure the wires are correctly orientated when plugging the battery into the vehicle.

When plugging the battery into the vehicle, Ensure the red (POS+) wire on the battery is connected to the red (POS+) wire of the ESC. Also ensure the black (NEG-) wire on the battery is connected to the black (NEG-) wire of the ESC.

Improper connection may damage electronics.



UNPLUG THE BATTERY PACK FROM THE VEHICLE!

BEFORE CHARGING YOUR BATTERY PACK, YOU MUST FIRST UNPLUG IT FROM THE ESC. FAILURE TO UNPLUG THE BATTERY FROM THE VEHICLE'S ESC BEFORE CHARGING MAY PERMANENTLY DAMAGE SOME OR ALL ELECTRONICS IN THE VEHICLE.

NEVER LEAVE BATTERY PACKS UNATTENDED WHILE CHARGING! Leaving a battery unattended while charging may result in fire and damage / injury.

NEVER ALLOW A BATTERY PACK TO GET HOT! It's normal for the battery pack to get warm, but it should never get hot! Monitor batteries during charging and unplug to let cool if the battery gets hot.

WHEN CHARGING LIPOs, A LIPO SAFE CHARGING BAG SHOULD BE USED TO HELP PREVENT FIRES.

EXPLODED VIEWS

TIRE/WHEEL ASSEMBLIES:

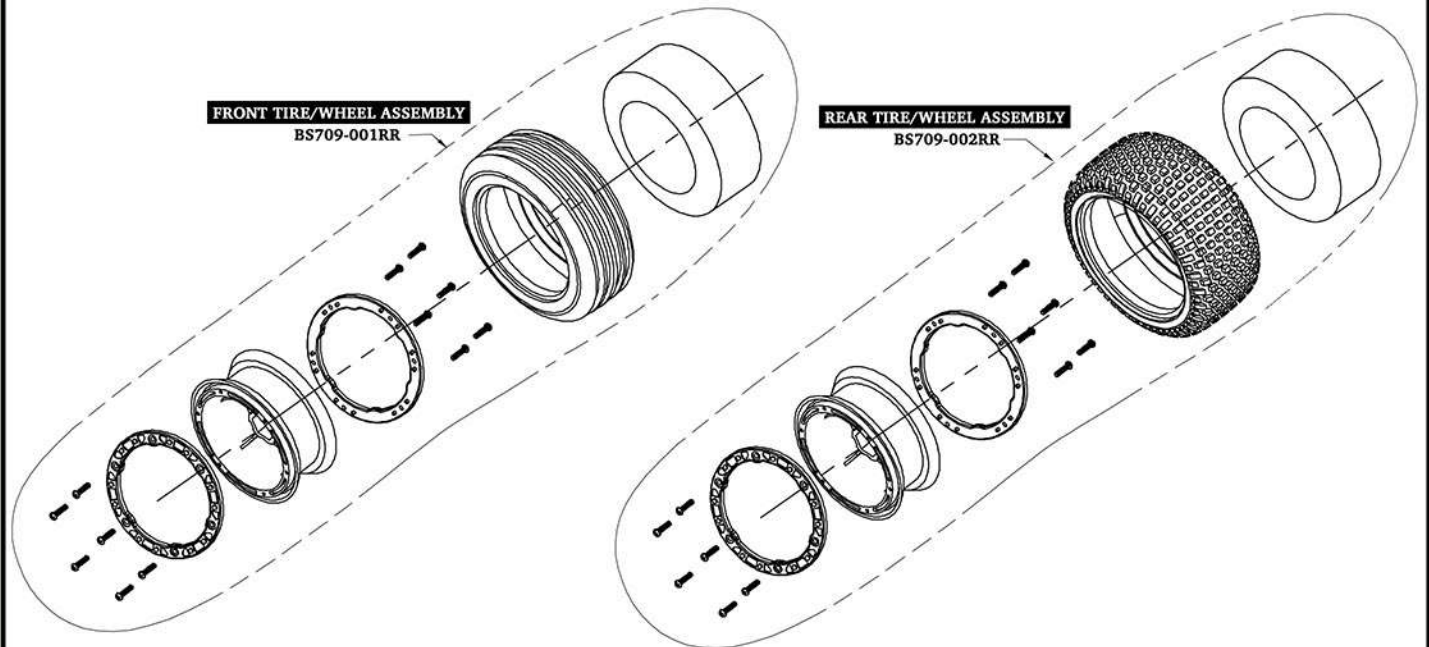

DIFFERENTIAL:

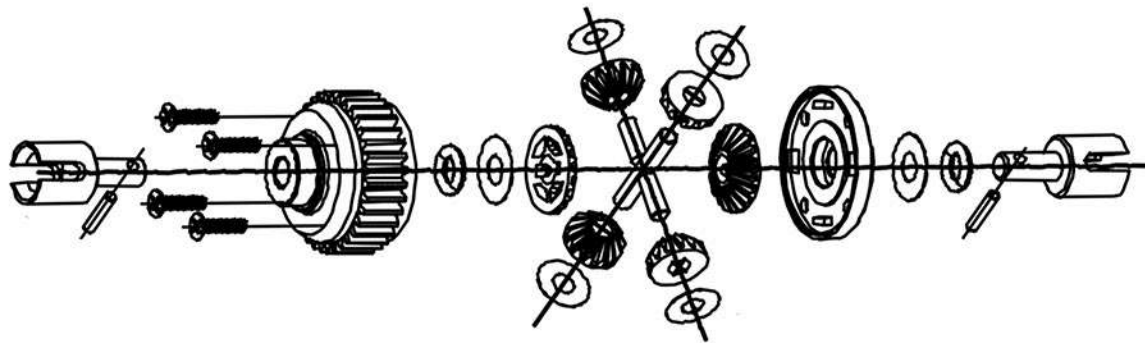



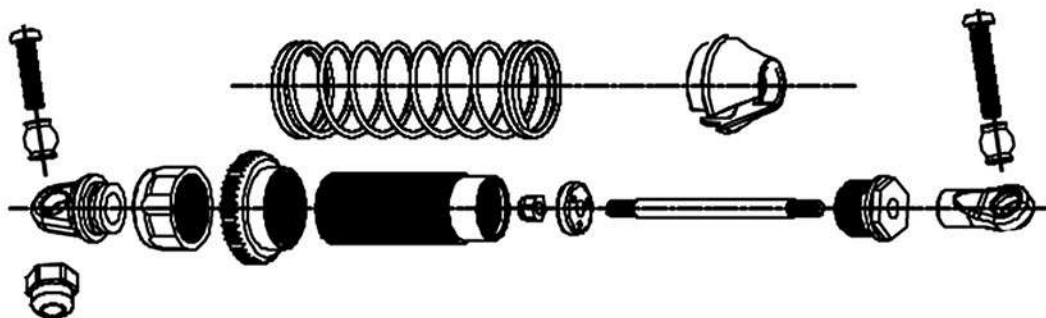







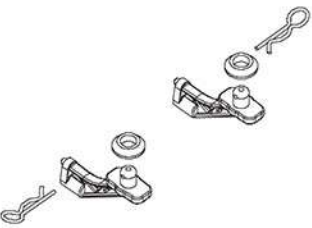

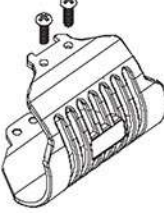
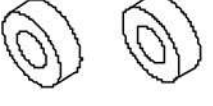
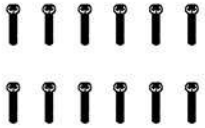

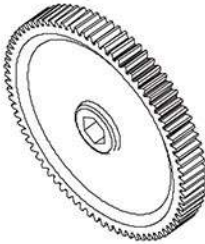

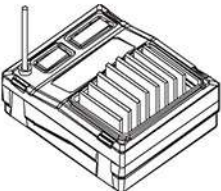

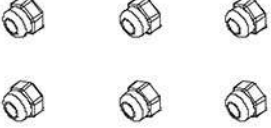
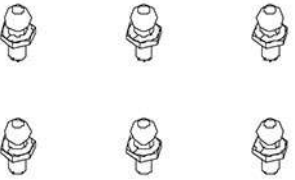
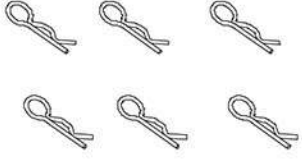
SHOCKS: BS709-004RR / BS709-019RR





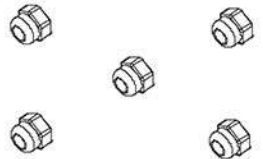



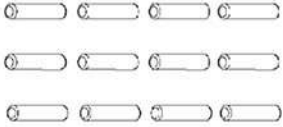

PARTS IDENTIFICATION

<p>BS709-001RR - Front Tire/Wheel assembly</p> 	<p>BS709-002RR - Rear Tire/Wheel assembly</p> 	<p>BS709-003 - Front shock tower</p> 	<p>BS709-004RR - Front shock absorber (2x)</p> 
<p>BS709-005 - Bumper (front)</p> 	<p>BS709-006 - Steering knuckle unit (left/right)</p> 	<p>BS709-007RR - Upper susp. link</p> 	<p>BS709-008 - Susp. arm (front) (left/right)</p> 
<p>BS709-009 - Servo bellcrank</p> 	<p>HX-3CC - Hexfly servo with clutch</p> 	<p>BS709-011RR - Steering link</p> 	<p>BS709-012 - Front upper deck</p> 
<p>BS709-013 - ESC case</p> 	<p>BS709-014 - Battery cover</p> 	<p>BS709-015 - Chassis</p> 	<p>BS709-016RR - Body (Blue) BS709-016R - Body (Red) BS709-016C - Body (Clear)</p> 
<p>BS709-017 - Roll bar set</p> 	<p>BS709-018 - Rear shock tower & brace</p> 	<p>BS709-019RR - Shock absorber (rear) (2x)</p> 	<p>BS709-020 - Susp. arm (rear) (left/right)</p> 
<p>BS709-021 - Hub carrier unit (rear) (2x)</p> 	<p>BS709-022N - Dog bone drive shaft (2x)</p> 	<p>BS709-070 - Gear box unit</p> 	<p>BS709-024RR - Motor w/23T pinion gear</p> 

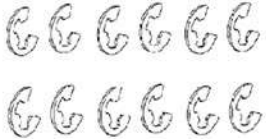
PARTS IDENTIFICATION

<p>BS709-025 - Tail wing mount</p> 	<p>BS709-026 - Tail wing (Blue) BS709-026R - Tail wing (Red) BS709-026C - Tail wing (Clear)</p> 	<p>BS709-027 - Motor guard set</p> 	<p>BS709-028 - Oil bearing</p> 
<p>BS709-029RR - BM3*25mm cross screw</p> 	<p>BS709-030RR - BM3*30mm cross screw</p> 	<p>BS709-032 - Spur gear</p> 	<p>BS709-053RR - Transmitter</p> 
<p>BS709-054 - Receiver/ESC 2-in-one</p> 	<p>BS903-067RR - TPF3*10mm cross screw</p> 	<p>BS903-079RR - BM3*10mm cross screw</p> 	<p>BS903-093 - M4 Nylon lock-nut</p> 
<p>BS205-043RR - Screw 4.7*12 (Ball stud)</p> 	<p>BS701-041 - 6# Body clip</p> 	<p>BS903-076RR - BT3*20mm cross screw</p> 	<p>BS903-074RR - BT3*14mm cross screw</p> 
<p>BS702-057RR - BM3*6mm cross screw</p> 	<p>BS902-045RR - BM3*8mm cross screw</p> 	<p>BS902-051RR - BT3*10mm cross screw</p> 	<p>BS901-066 - M3 locknut</p> 
<p>BS903-070RR - ISO3*10mm cross screw</p> 	<p>HX-N802 - 2A NiMH fast charger</p> 	<p>OPTIONAL BATTERY HX-3800MH-B - Hexfly 3800 mAh 7.2V NiMH Rechargeable Battery</p> 	<p>OPTIONAL BATTERY HX-5000MH-B - Hexfly 5000 mAh 7.2V NiMH Rechargeable Battery</p> 

PARTS IDENTIFICATION

<p>BS903-089 - PIN 2*9.5 (12pcs)</p> 	<p>BS903-072RR - BT 3*8 (12pcs)</p> 	<p>BS903-086 - Ball bearing 5*10*4 (2pcs)</p> 	<p>BS903-088 - E-Clip (12pcs)</p> 
<p>BS903-087 - Ball bearing 12*18*4 (2pcs)</p> 	<p>BS709-079 - Ball bearing 5*8*2.5 (2pcs)</p> 	<p>BS901-046 - Ball bearing 4*8*3</p> 	<p>BS709-067 - Cylinder head hex screws HM3*35</p> 
<p>BS810-096 - Meson head machine screw PWB 2.5*6*4.8</p> 	<p>BS709-034 - 23T Motor pinion gear</p> 		

OTHER REDCAT RACING PRODUCTS

Established in 2005, Redcat Racing has become the premier name for Fast- Affordable - Fun, ready to run, remote controlled surface vehicles. Here are a few which might interest you.

VOLCANO EPX



- Motor: Electric Brushed 19T 550
- Trans: Forward and Reverse
- Drive: 4 Wheel Drive
- Shocks: Aluminum Capped Oil Filled Shocks
- ESC: Brushed
- Radio System: 2.4GHz
- Battery: 7.2v 2000mAh NIMH & Charger Included
- Length: 400mm
- Width: 310mm
- Height: 185mm
- Wheelbase: 275mm
- Clearance: 30mm

<http://www.redcatracing.com/Volcano-EPX>

VOLCANO EPX PRO



- Motor: Electric Brushless 3300KV RC540
- Trans: Forward and Reverse
- Drive: 4 Wheel Drive
- Shocks: Aluminum Oil Filled
- ESC: Brushless (2S LIPO Ready)
- Radio System: 2.4GHz
- Battery: 7.4v 3500mAh 2S LIPO 15C & Charger Included
- Length: 400mm
- Width: 310mm
- Height: 185mm
- Wheelbase: 275mm
- Clearance: 30mm

<http://www.redcatracing.com/Volcano-EPX-PRO>

THUNDER-DRIFT



- Motor: Electric Brushed
- Trans: Forward and Reverse
- Drive: 4 Wheel Drive Belt-Driven
- Special Drift Tires
- Shocks: Aluminum Oil Filled
- ESC: Brushed ESC
- Radio System: 2.4GHz
- Battery: 7.2v 2000mAh NIMH & Charger Included
- Length: 360mm
- Width: 200mm
- Height: 112mm
- Wheelbase: 260mm
- Clearance: 4.5mm

<http://www.redcatracing.com/Thunder-Drift>

TERREMOTO 10 V2



- Motor Type: Electric Brushless
- Transmission: Forward and Reverse
- Drive System: 4 Wheel Drive
- Length: 500mm
- Width: 360mm
- Height: 210mm
- Wheelbase: 316mm
- Ground Clearance: 55mm
- Shocks: Aluminum Oil Filled Long Travel
- Speed Control: Brushless 60a ESC (3s LIPO Ready)
- Battery: 7.4v 3200mAh LIPO Battery & Charger Included
- Radio System: 2.4GHz Radio System



<http://www.redcatracing.com/Terremoto10-Brushless>

WARRANTY INFO

This product carries a 90 day limited warranty.

If you have any questions, issues, or concerns about this product, please visit the support section of the Redcat Racing website.

Warranty Information:

<http://www.redcatracing.com/Warranty-Information>

Warranty Claim Form:

<http://www.redcatracing.com/Warranty-Claim-Form>



FAST AFFORDABLE FUN™

www.redcatracing.com

 Follow us on FaceBook: <https://www.facebook.com/RedcatRacing>

•To ensure that you are using the most recent version of this manual:
www.redcatracing.com/manuals/CYCLONEXB10MANUAL.pdf
•To ensure that you have the most recent version of the Electronic Vehicles Manual:
www.redcatracing.com/manuals/ELECTRIC-MANUAL.pdf