



BLACKOUT™ XTE

1/10 SCALE MONSTER TRUCK
OWNERS MANUAL

IMPORTANT LINKS:

Link to the most recent version of this manual with exploded views and parts lists:
<https://www.redcatracing.com/pages/manuals>

Link to electric vehicles manual:
<https://www.redcatracing.com/manuals/ELECTRIC-MANUAL.pdf>



WARNING!

READ ALL INSTRUCTIONS INCLUDED WITH VEHICLE BEFORE OPERATING

**AGE WARNING!**

This radio controlled (RC) vehicle is not a toy! You must be 14 years of age or older to operate this vehicle. Adult supervision is required.

**RISK OF RUNAWAY VEHICLE OR INJURY!**

Never turn on the vehicle or plug in the battery pack without first having the controller turned on.

**RISK OF FIRE! / RISK OF EXPLOSION!**

There is a risk of fire and explosion when dealing with batteries. Rechargeable batteries may become hot and catch fire if left unattended or charged too quickly. Use extra caution when charging LiPO batteries. Use only LiPO specific chargers. Use a LiPO safe charging pouch when charging LiPOs. Charge away from flammable materials. Never charge at a rate higher than 1C. {2000Mah pack= 2amps charge rate). Overcharging can lead to fire and explosion. Always store battery packs in a cool dry place.

**RISK OF BURNS!**

The batteries, electronic speed controller (ESC), electric motor, and other areas of the vehicle can get hot. Burns can occur if touched after vehicle operation. Allow adequate time to cool before handling.

**RISK OF ELECTRICAL SHOCK!**

Use caution when charging batteries. Do not touch positive and negative leads together. Do not lay battery on metal. Use only chargers specified for the battery type being charged. Keep batteries and chargers away from water.

**RISK OF INJURY!**

Hobby grade RC vehicles can cause serious injury or death if not operated correctly. Never use vehicle in crowds. Never chase people or animals. Drive in safe open areas only. Keep body parts away from moving parts.

**RISK OF DAMAGE!**

Never operate RC vehicles on public roads. Damage of vehicle and property can occur. Only operate on open private property. Never charge the battery pack while it is still plugged into the RC vehicle. Always unplug the battery pack from the electronic speed controller (ESC) and remove the battery from the RC vehicle before charging. Failure to do so will result in damage to the vehicle's electronics.

**WARNING!**

Do not mix old and new batteries. Do not mix alkaline, lithium, standard (carbon zinc), or rechargeable (nickel cadmium) batteries. Do not change or charge batteries in a hazardous location.



FCC Compliance Statement! The radio included with your vehicle complies with part 15 of the FCC Rules. Operation is subject to the following two conditions: (1) This device may not cause harmful interference, and (2) This device must accept any interference received, including interference that may cause undesired operations. Note: This equipment has been tested and found to comply with the limits for a Class B digital device, pursuant to Part 15 of the FCC Rules. These limits are designed to provide reasonable protection against harmful interference in a residential installation. This equipment generates, uses and can radiate radio frequency energy and, if not installed and used in accordance with the instructions, may cause harmful interference to radio communications. However, there is no guarantee that interference will not occur in a particular installation. If this equipment does cause harmful interference to radio or television reception, which can be determined by turning the equipment off and on, the user is encouraged to try to correct the interference by one of the following measures:

Reorient or relocate the receiving antenna.

Increase the separation between the equipment and receiver.

Connect the equipment into an outlet on a circuit different from that to which the receiver is connected.

Consult the dealer or an experienced radio/TV technician for help.

WARNING: Any changes or modifications not expressly approved by the party responsible for compliance could void the user's authority to operate this equipment.

WARNING: While operating the Radio, a separation distance of at least 20 centimeters must be maintained between the radiating antenna and the body of the user or nearby persons in order to meet the FCC RF exposure guidelines.

FEATURES & SPECIFICATIONS

- Brushed Electric Motor
- Waterproof ESC
- Forward & Reverse
- 4 Wheel Drive
- Oil Filled Shocks
- 7.2v NiMH Battery
- Battery Charger
- 2.4GHz Radio System
- Scale: 1/10
- Length: 440mm
- Width: 275mm
- Height: 140mm (without body)
- Wheelbase: 290mm

VEHICLE OVERVIEW

A: Oil Filled Shocks

B: Steering Servo

C: Battery

D: Chassis Brace

E: On/Off Switch

F: 2.4GHz Receiver

G: ESC

H: Electric Motor

I: Steering Linkage

J: Upper Suspension Link

K: Rear Toe In/Out Link

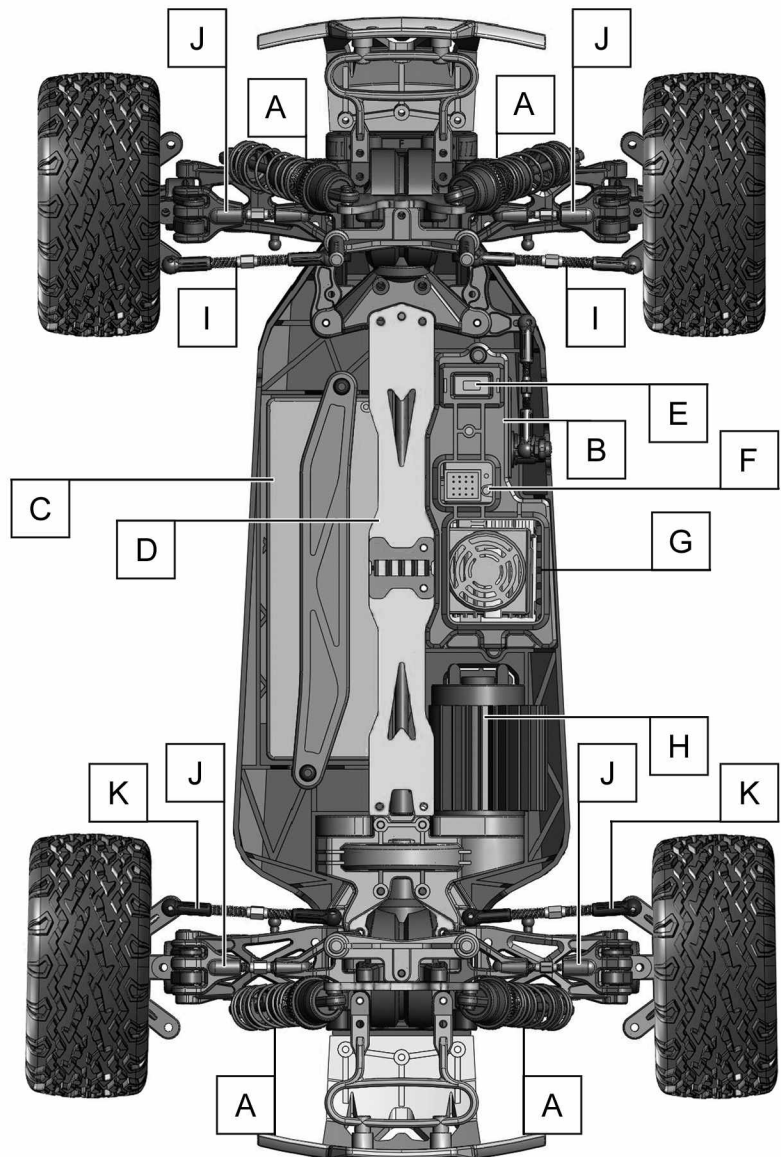

RADIO GUIDE

CONTROL PANEL

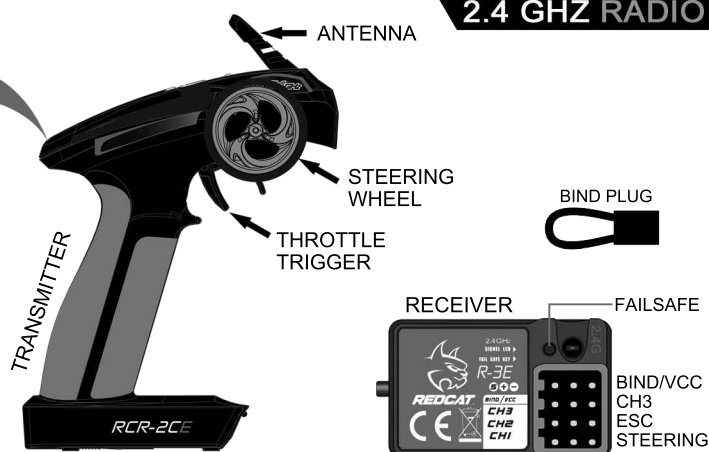
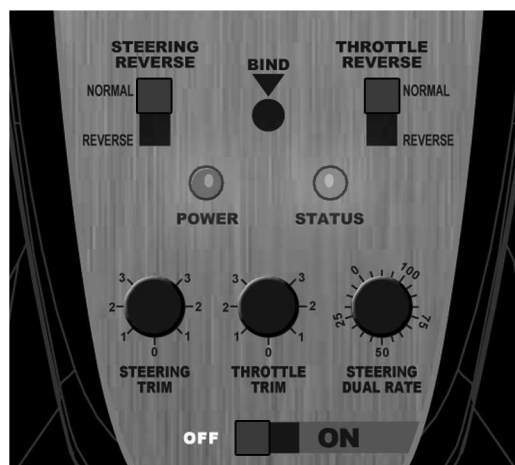

2.4 GHZ RADIO

RADIO:

Steering Reverse Switch: Top left switch. Used to change steering orientation. If the car turns right when you steer left, flip this switch.

Throttle Reverse Switch: Top right switch. Used to change throttle trigger orientation. If the car goes in reverse while you pull the throttle trigger, flip this switch.

Power LED: Left LED light. Lights up when the transmitter is turned on.

Status LED: Right LED light. Lights up green when transmitter batteries are full. Flashes when transmitter batteries are low and need replacing.

Bind Button: Used to bind the transmitter to the receiver. See binding instructions.

Steering Trim: Left knob. Used to set the steering neutral point. If the vehicle veers in one direction while the steering wheel is centered, turn this knob in the opposite direction until the car drives straight.

Throttle Trim: Middle knob. Used to set the throttle neutral point. If the vehicle moves forward or reverse while the throttle trigger is centered, turn this knob until the vehicle remains still. For maximum setting, turn slowly until the vehicle creeps forward, then turn the knob the opposite direction until the car stops.

Steering Dual Rate: Right knob. Used to limit the amount of steering. 0= little/no steering & 100= maximum steering. Set the knob to the amount of steering you feel comfortable with. If the vehicle has a tendency to spin out, lower the steering rate.

On/Off Switch: Bottom switch. Turns transmitter On and Off.

RECEIVER:

BIND/VCC: Used when binding to transmitter.

Ch3: Used for 3rd channel when needed.

Ch2: Used for electronic speed controller (ESC).

Ch1: Used for steering servo.

Failsafe Button: Used to set failsafe.

BINDING:

1. Insert the BIND PLUG into the receiver BIND port.
2. Make sure your ESC is plugged into CH2, and insert the bind plug into BIND/VCC. Now, power the vehicle on and the receiver light should begin to blink red.
3. Press the BIND button in the center of the transmitter's Control Panel and turn on radio.
4. Release the bind button when you see the green light on the radio flashing. At this point, your receiver's LED light should pause for approximately 1 second and then blink slowly. Turn off the power to your vehicle, as well as the radio.
5. Remove the BIND PLUG from the receiver. Make sure the servos and ESC are attached as described above.
6. First turn your radio on, then your vehicle as normal. Your radio and receiver should be bound together and communicating with each other.

CHARGING THE NIMH BATTERY

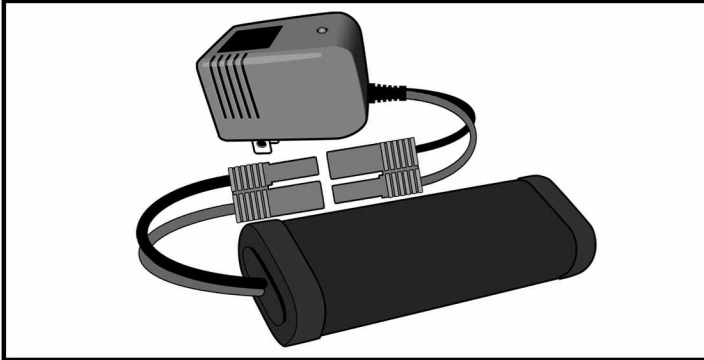

ATTENTION

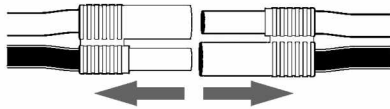

Before attempting to charge your NiMH battery, be sure to remove it from the vehicle and place it on a nonflammable surface away from hazards, such as curtains, couches, or clothing.

Warning! Batteries can potentially catch fire if over charged or charged incorrectly.

NIMH Charging:

Charging NiMh battery packs with the included charger is simple.

1. Unplug and remove the battery from the RC vehicle.
2. Plug the charger into a 110v wall receptacle.
3. Plug the battery pack into the charger.

When plugging the battery into the charger, ensure the red (POS+) wire on the battery is connected to the red (POS+) wire of the charger. Also ensure the black (NEG-) wire on the battery is connected to the black (NEG-) wire of the charger.

Charge times vary according to charger current and battery mAh. **Battery mAh ÷ Charger mA = Approximate charge time**

Ex. 2000mAh battery ÷ 500 mA charger = ~4 hours charge time.

BATTERY → CHARGER ↓	2000mAh	2200mAh	3000mAh	3800mAh
250mA	8 hrs	8.8 hrs	12 hrs	15.2 hrs
500mA	4 hrs	4.4 hrs	6 hrs	7.6 hrs
650mA	3 hrs	3.4 hrs	4.6 hrs	5.8 hrs

ATTENTION

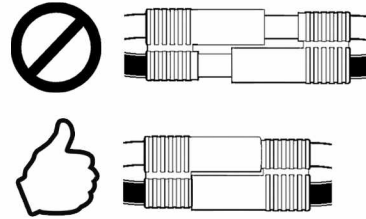

BATTERY CONNECTION INSTRUCTIONS:
Make sure battery connectors are fully pushed in when charging and connecting to the vehicle.

ATTENTION

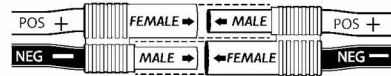

Be sure the wires are correctly orientated when plugging the battery into the vehicle.

When plugging the battery into the vehicle, Ensure the red (POS+) wire on the battery is connected to the red (POS+) wire of the ESC. Also ensure the black (NEG-) wire on the battery is connected to the black (NEG-) wire of the ESC.

Improper connection may damage electronics.

STOP WARNING STOP

UNPLUG THE BATTERY PACK FROM THE VEHICLE!

BEFORE CHARGING YOUR BATTERY PACK, YOU MUST FIRST UNPLUG IT FROM THE ESC. FAILURE TO UNPLUG THE BATTERY FROM THE VEHICLE'S ESC BEFORE CHARGING MAY PERMANENTLY DAMAGE SOME OR ALL ELECTRONICS IN THE VEHICLE.

NEVER LEAVE BATTERY PACKS UNATTENDED WHILE CHARGING! Leaving a battery unattended while charging may result in fire and damage / injury.

NEVER ALLOW A BATTERY PACK TO GET HOT! It's normal for the battery pack to get warm, but it should never get hot! Monitor batteries during charging and unplug to let cool if the battery gets hot.

WHEN CHARGING LIPOs, A LIPO SAFE CHARGING BAG SHOULD BE USED TO HELP PREVENT FIRES.

PARTS IDENTIFICATION

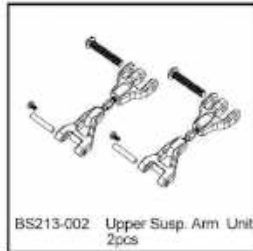
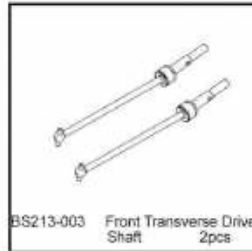
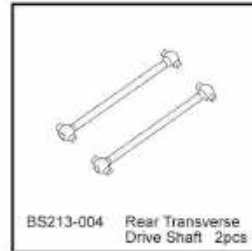
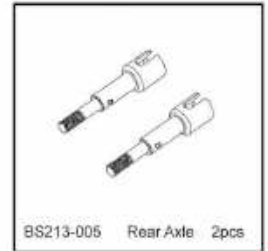

BS214-011 Big Bore Shock (2pcs)

BS213-002 Upper Susp. Arm Unit
2pcsBS213-003 Front Transverse Drive
Shaft
2pcsBS213-004 Rear Transverse
Drive Shaft 2pcs

BS213-005 Rear Axle 2pcs

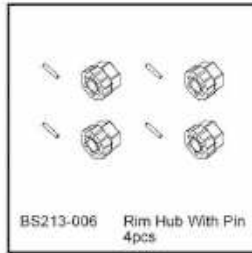
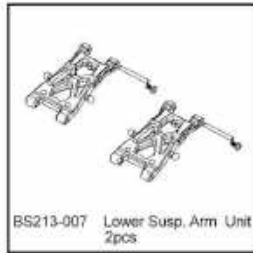
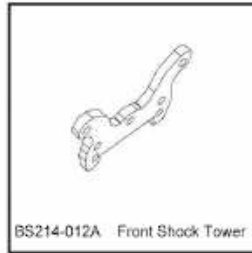
BS213-006 Rim Hub With Pin
4pcsBS213-007 Lower Susp. Arm Unit
2pcs

BS214-012A Front Shock Tower

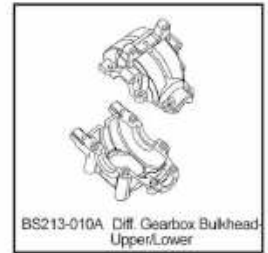
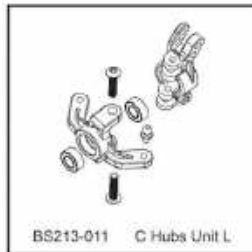

BS214-013A Rear Shock Tower

BS213-010A Diff. Gearbox Bulkhead
Upper/Lower

BS213-011 C Hubs Unit L.

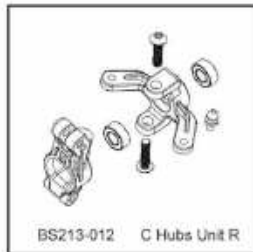

BS213-012 C Hubs Unit R.

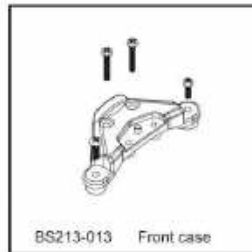

BS213-013 Front case

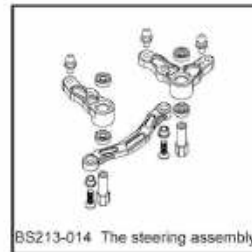

BS213-014 The steering assembly



BS213-016 Steering Link 4pcs

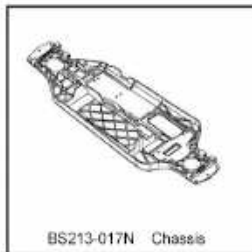

BS213-017N Chassis



BS213-018 Battery Cover



BS213-019A Fr. Upper Desk

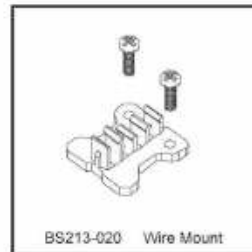

BS213-020 Wire Mount



BS213-021 Drive shaft unit

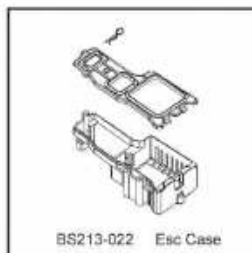

BS213-022 Esc Case

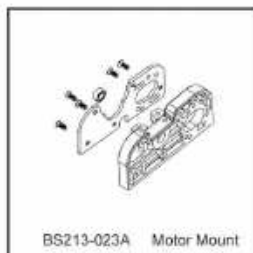

BS213-023A Motor Mount

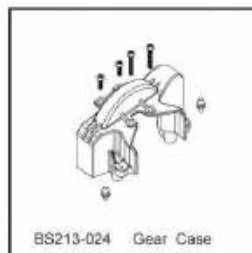

BS213-024 Gear Case



BS213-026 Spur Gear 55T

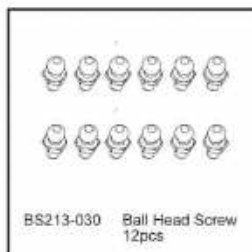

BS213-028A Rr. Upper Desk

BS213-030 Ball Head Screw
12pcs

BS213-031 Front Chassis

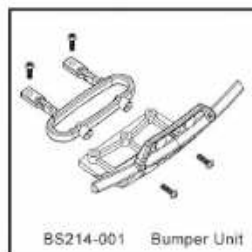

BS214-001 Bumper Unit

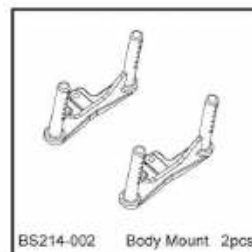

BS214-002 Body Mount 2pcs



BS214-003T Truck Body

PARTS IDENTIFICATION



BS214-003SUV SUV Body



BS214-009 Tire Unit 2pcs

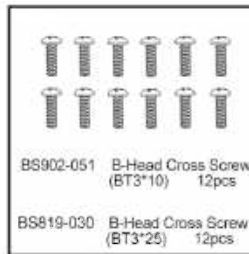

BS902-051 B-Head Cross Screw (BT3*10) 12pcs
BS819-030 B-Head Cross Screw (BT3*25) 12pcs

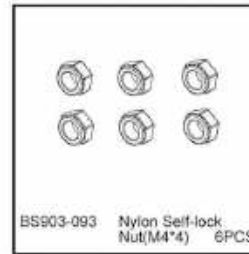

BS903-093 Nylon Self-lock Nut(M4*4) 6PCS

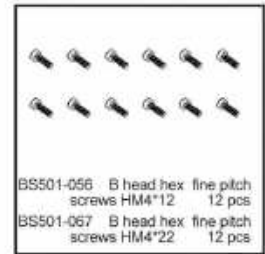

BS501-056 B head hex fine pitch screws HM4*12 12 pcs
BS501-067 B head hex fine pitch screws HM4*22 12 pcs

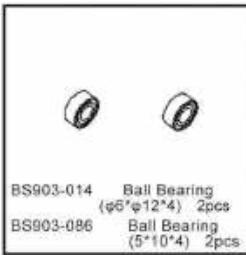

BS903-014 Ball Bearing (φ6*φ12*4) 2pcs
BS903-086 Ball Bearing (5*10*4) 2pcs

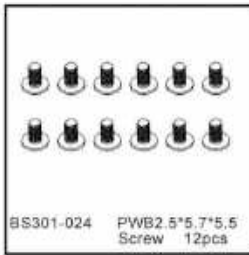

BS301-024 PWB2.5*5.7*5.5 Screw 12pcs

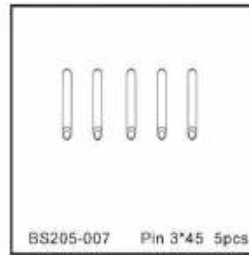

BS205-007 Pin 3*4.5 5pcs

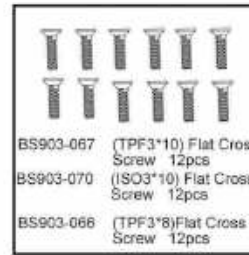

BS903-067 (TPF3*10) Flat Cross Screw 12pcs
BS903-070 (ISO3*10) Flat Cross Screw 12pcs
BS903-066 (TPF3*8) Flat Cross Screw 12pcs

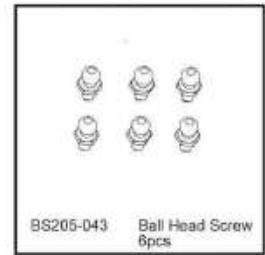

BS205-043 Ball Head Screw 8pcs



BS903-079 B-Head Cross Screw (BM3*10) 12pcs
BS903-075 B-Head Cross Screw (BT3*16) 12pcs

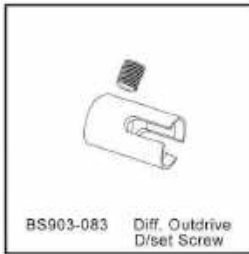

BS903-083 Diff. Outdrive D/set Screw

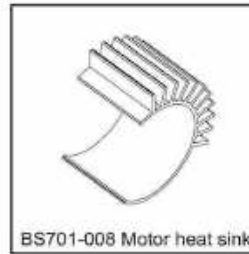

BS701-008 Motor heat sink

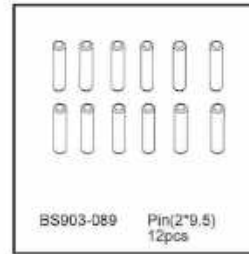

BS903-089 Pin(2*9.5) 12pcs



RCR-20ENR 2.4GHz Radio. Includes Radio, and Manual only. No receiver



28480 2.4Ghz 2ch Splash Proof Receiver



BS213-044 Servo Saver

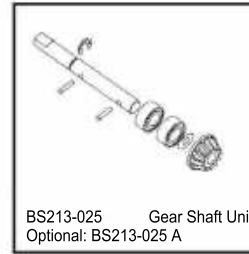

BS213-025 Gear Shaft Unit
Optional: BS213-025 A

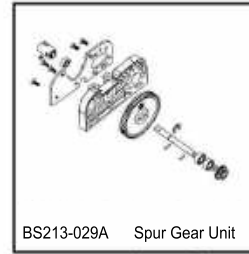

BS213-029A Spur Gear Unit

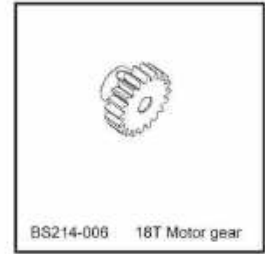

BS214-006 18T Motor gear



BS903-104 Diff. Unit
Optional: BS803-026A (hardened)



BS903-117 Master Gear Unit (Zinc Alloy)



HX-3CP 3kg Waterproof Steering Servo

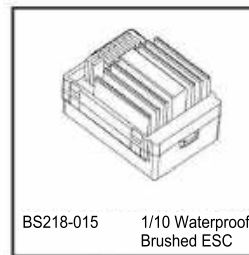

BS218-015 1/10 Waterproof Brushed ESC

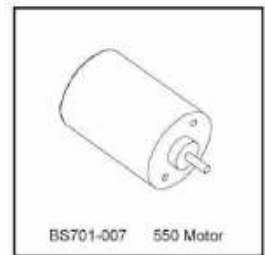

BS701-007 550 Motor



HX-01003B Charger for 7.2V NiMH Battery

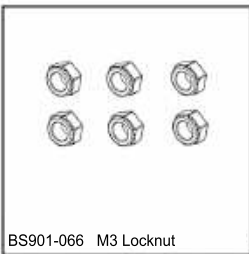

BS901-066 M3 Locknut

PARTS IDENTIFICATION

BS213-014 Steering System Unit

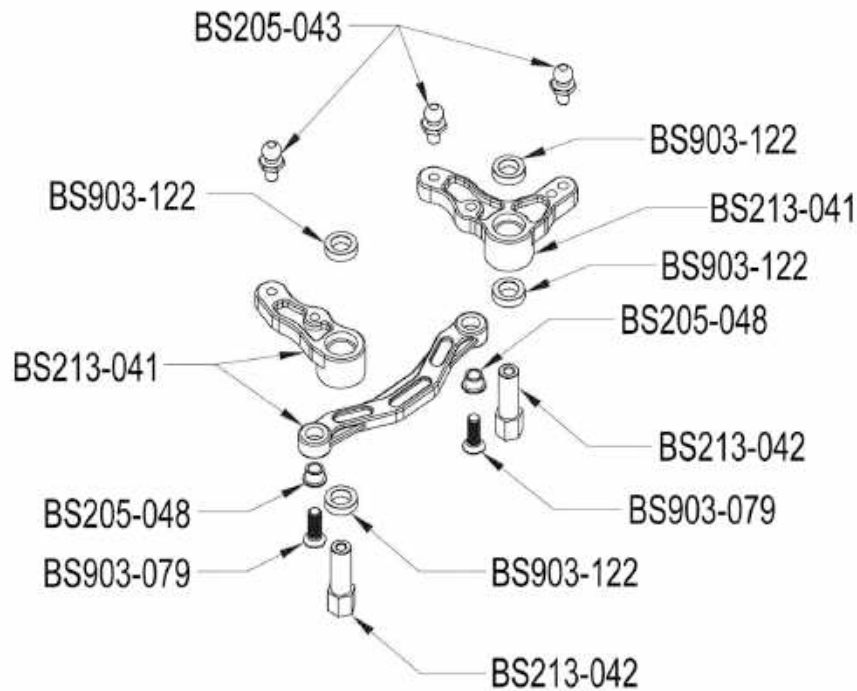

BS205-043 Ball head screw
4.8*12.3

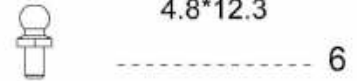

BS903-122 Copper bush
5.1*8*2.5

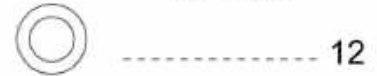

BS205-048 Spacer bush
3.05*3.7



BS903-079 B-Head Cross
Screw(BM3*10)

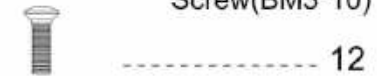

BS213-039 Steering Axis
(5*20.9)





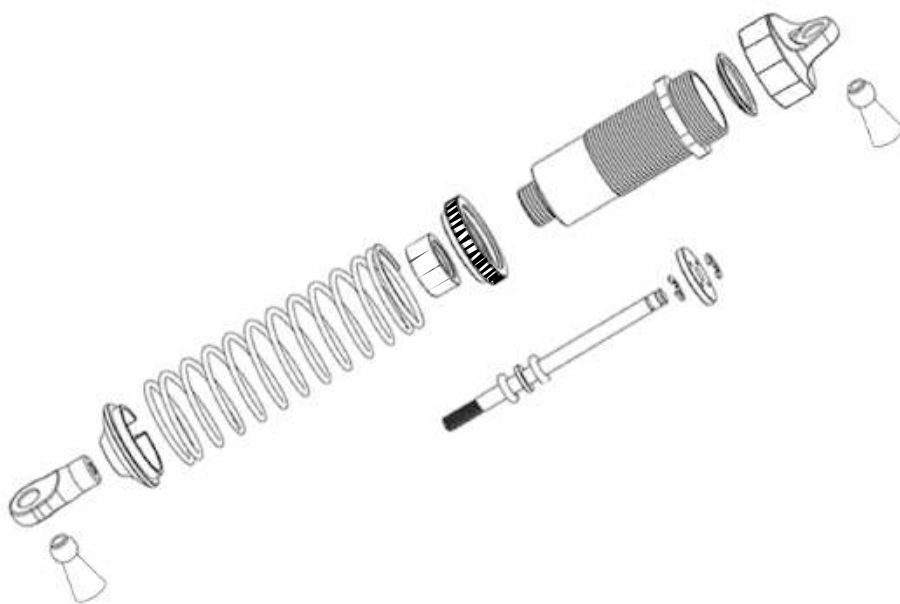



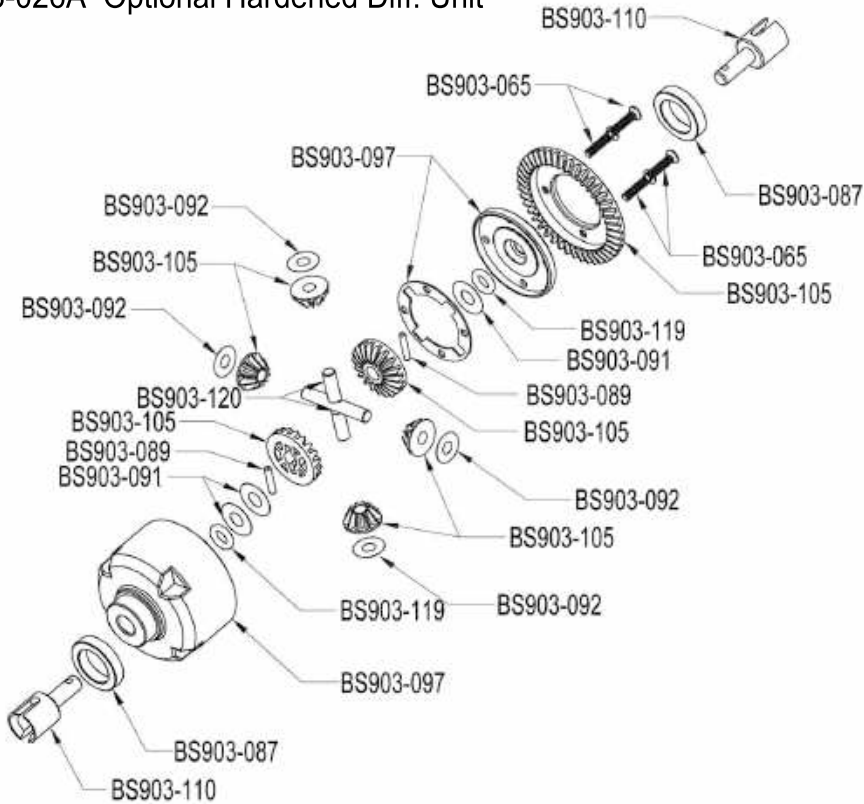

BS214-011 Big Bore Shock



PARTS IDENTIFICATION







BS903-104 Diff Gear box unit
 BS803-026A Optional Hardened Diff. Unit

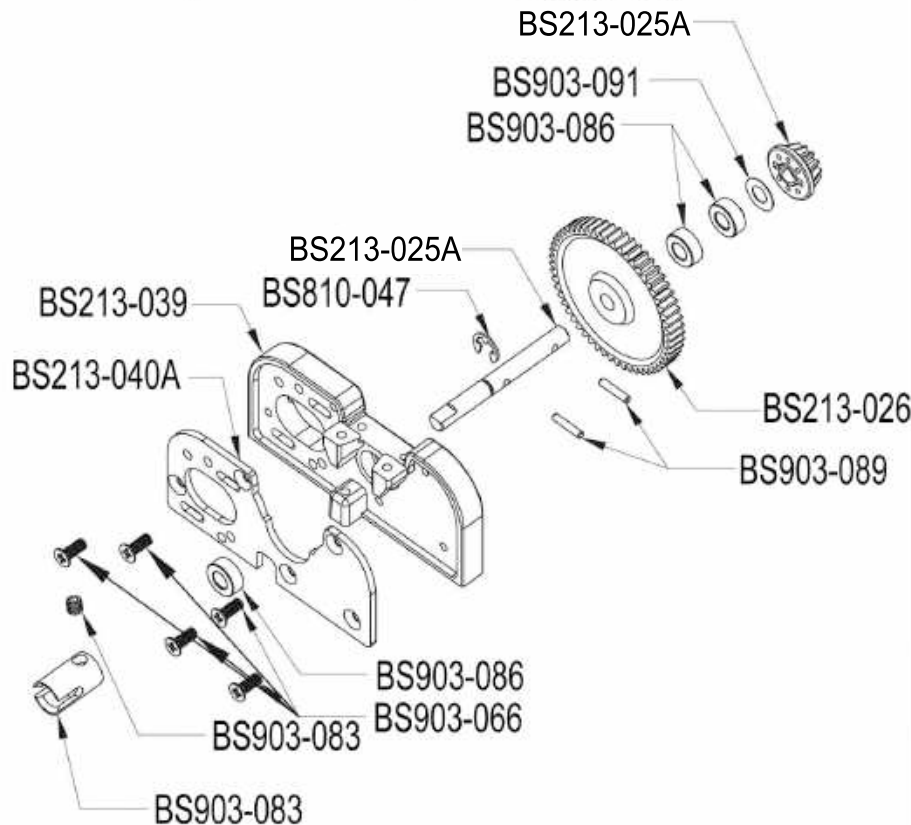

- BS903-110 Joint B  1
- BS903-087 Ball Bearing(12*18*4)  2
- BS810-038 B head hex fine pitch screws HM2.5*12  12
- BS903-119 O ring 5*9*2  12
- BS903-091 Washer A(5.2*10*0.2)  12
- BS903-092 Washer B(4.2*8*0.2)  12
- BS903-089 Pin(2*9.8)  12
- BS903-120 Diff Gear Shaft (4*26.2)  6

BS214-029A Spur Gear Unit



- BS903-091 Washer A (5.2*10*0.2)  12
- BS903-086 Ball Bearing 5*10*4  2
- BS903-089 Pin 2*9.8  12
- BS810-047 E clip  12
- BS213-025A Gear shaft  1
- BS903-066 Flat Cross Screw(TPF3*8)  12
- BS903-083 Joint D  1



www.REDCATRACING.COM

Follow us on social media

Take a photo, create a video, post and share your Redcat experience.

Stay up to date on the latest Redcat news, products, and creative content. While these profiles are not customer service channels, you might find that one of our subject experts or another member of the community is able to assist you. If you have an issue or need technical and or product support, please reach out to Redcat directly through our website.

 <https://www.facebook.com/RedcatRacing>

 <https://www.instagram.com/RedcatRacing>

 <https://www.youtube.com/RedcatRacing>

 <https://www.twitter.com/RedcatRacing>

 <https://www.pinterest.com/RedcatRacing>

IMPORTANT LINKS:

Link to the most recent version of this manual with exploded views and parts lists:
<https://www.redcatracing.com/pages/manuals>

Link to electric vehicles manual:
<https://www.redcatracing.com/manuals/ELECTRIC-MANUAL.pdf>