

REDCAT-RACING

1/8 4WD NITRO DESERT TRUCK

MODEL NO.:AFTERSHOCK 3.5 2-Speed Transmission



Product Size:

Length: 504mm

Width: 305mm

Height: 165mm

Wheelbase: 325mm

Tire size: $\Phi 117 \times 44\text{mm}$

Ground clearance: 33mm

Engine: 21#

Instruction Manual

Highlights:

- 4WD drive system.
- 21cc powerful engine with two speed needles and slide carb.
- Waterproof and dustproof sealed gearbox.
- Auto-shifting 2-speed transmission.
- Sealed superduty plastic driveshaft.
- Fast easy assembly and disassembly receiver and battery cover.
- Super diff. with four bevel gears.
- Blue anodised 3mm 6061 T6 chassis.
- Sealed gearbox waterproof and dustproof, durable and stable.
- Adjustable threaded long oil-filled shock absorber.
- Fuel tank 125cc.
- Precise sealed ball bearing.

⚠ SAFETY PRECAUTIONS

- This radio controlled racing car is not a toy!
- This high-performance R/C model is recommended for ages 14 and older.
- First-time builders should seek the advice of experienced modellers before commencing assembly.
- Take enough safety precautions prior to operating this model. You are responsible for this model's assembly and safe operation!

www.redcatracing.com

Required equipment for operation

1. Tools required for buildin and maintenance:

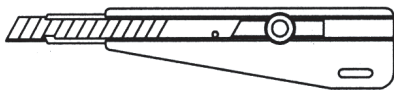

● Hobby knife

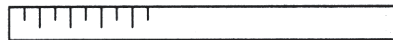

● Precision ruler

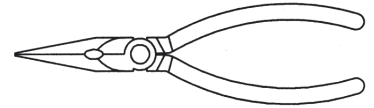

● Needle nose pliers

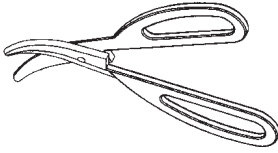

● Hobby scissors

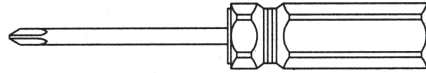

● Flat and Philips screwdrivers

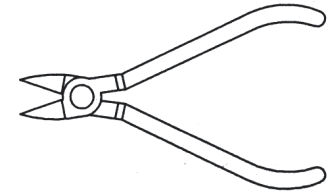
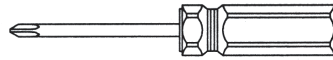

● Wire cutters

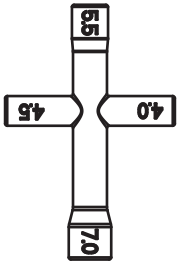

● Cross wrench

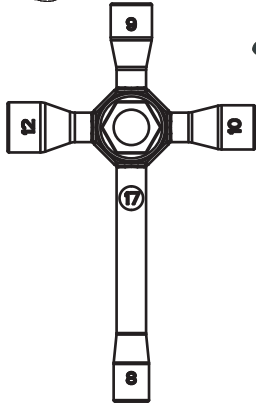

● Cross wrench



● CA glue & rubber cement

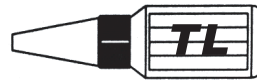

● Thread locking compound



1. 5mm

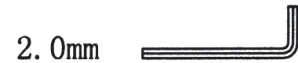

2. 0mm

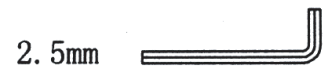

2. 5mm

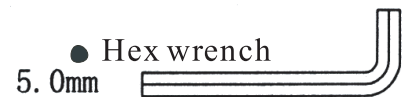

● Hex wrench
5. 0mm

WARNING!

Do not use a power screw driver to install screws into nylon or plastic materials. The fast locking may heat up the screws being installed that may break the molded parts or strip the threads during installation.

2. Additional items needed for operation:

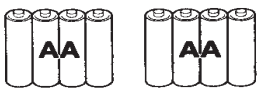

8pcs AA alkaline batteries for transmitter

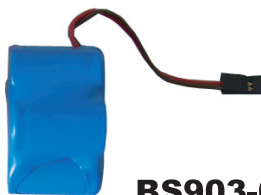

BS903-084
6.0V Ni-MH 2/3A1200mAh & its charger



B7004
Glow igniter & its charger



BS903-108



B7010
500CC or 350CC Fuel bottle

IMPORTANT!!!

Check all the screws are tight before playing the car!
Use thread lock on all screws that work loose.

Transmitter Specifications :

Channels: 2 channels
 Model Type: Car/boat
 RF Power: Less than 20dbm
 Modulation: GFSK
 Code Type: Digital
 Sensitivity: 1024
 Low Voltage Warning: Yes (less than 9V)
 DSC Port: Yes (3.5mm)
 Charger Port: Yes
 Power: 12vdc (1.5AA*8)
 Weight: 328g
 ANT Length: 26mm
 Size: 159*99*315mm
 Color: Black
 Certificate: CE FCC

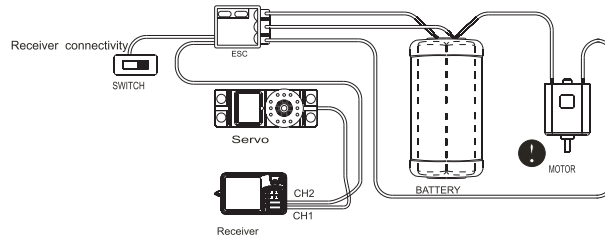
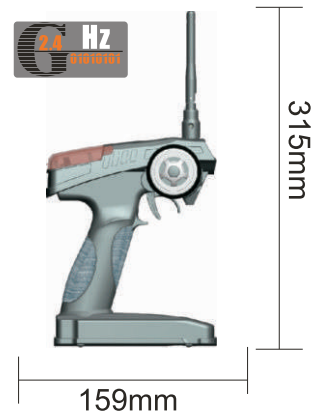

Note:

Place the antenna of the receiver vertically, and do not have contact with metal component. (See Figure1)

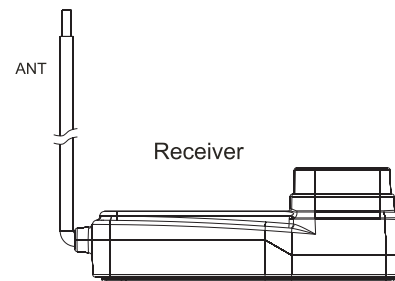

Binding:

The transmitter and receiver should already be bound by the factory by default .

1. Install batteries into the transmitter and shut it down.
2. Insert the bind cable on to the bind channel (Ch3) on the receiver. (Figure.2)
3. Connect the receiver battery to the VCC port on the receiver .The two LEDs on the receiver should flash rapidly, indicating the receiver is in binding state .
4. Press and hold the bind button on the transmitter , and then turn on the transmitter.
5. The LED on the receiver should stop flashing when the binding process completed (about 5 second)
6. Release the bind button on the transmitter , remove the bind cable from the receiver.
7. Install the servo and then test.
8. If the test succeeds , then remove the power supply from the VCC port.
9. The binding process completed.

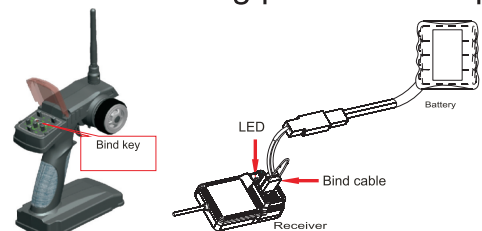
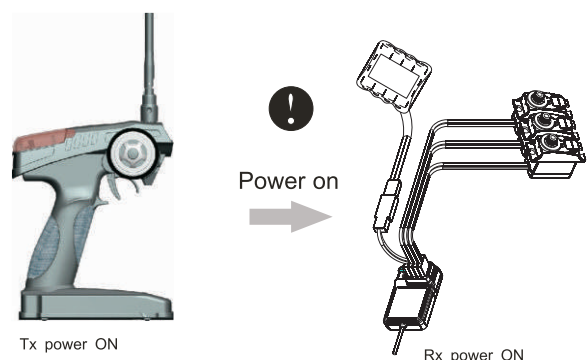

Figure 2

Turn On:

1. Turn on the transmitter.
2. Connect the power supply of the receiver.
3. Receiver LED light should turn solid.
4. Ready to use.



Shut Down:

1. Disconnect the receiver's power supply.
2. Turn off the transmitter .

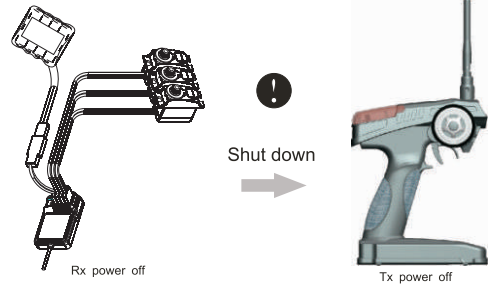

Transmitter Functions:

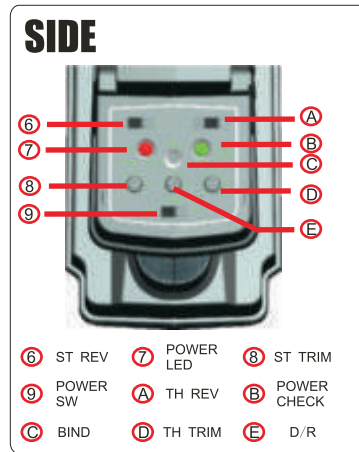
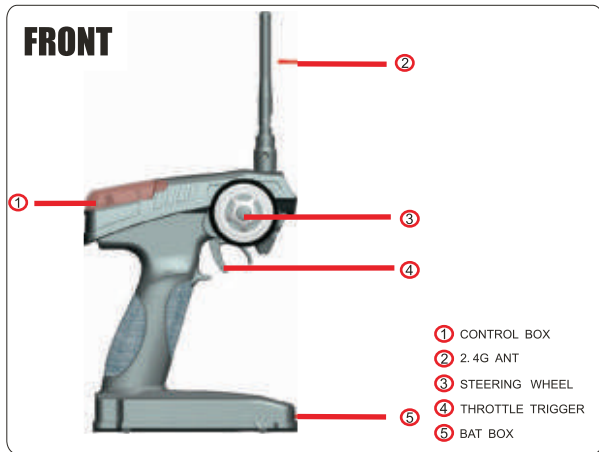

This function is to control the direction of the vehicle

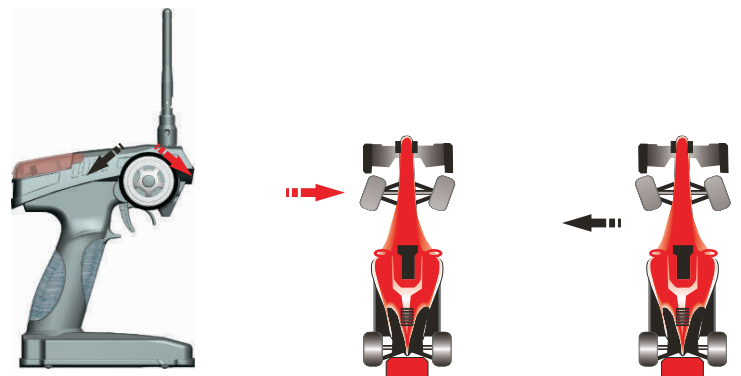

This function is to control the throttle speed of the vehicle

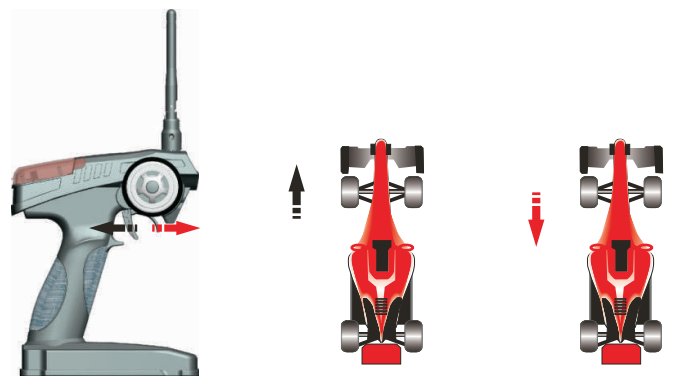

ENGINE TUNING GUIDE

HIGH-SPEED NEEDLE

The "high-speed" needle is sticking up from the carburetor. This controls the fuel to air mixture of the carburetor. The needle is pre-set for break-in from the factory at 2-1/2 turns out from fully closed. Once the engine is broken-in, the high-speed needle would typically run from 2 to 2-1/2 turns out from closed, depending on the weather, humidity and altitude above sea level. To richen the mixture turn the needle counterclockwise. To lean it, turn the needle clockwise.

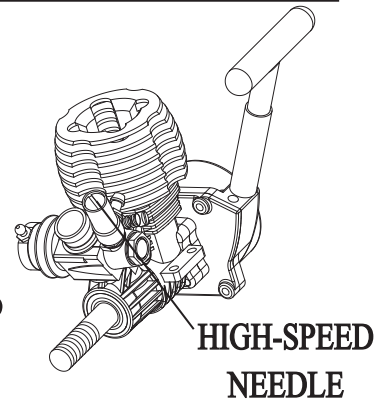

The Low-Speed Needle (For 18# engine)

The "low-speed" needle is the screw in the carb body opposite the throttle arm. It controls the fuel to air mixture at low throttle settings. There is a simple way of adjusting the low-speed needle correctly called the "pinch test." With the engine at idle, pinch the fuel line and listen to how the engine speeds up or slows down. If the engine increases its speed for about 2 or 3 seconds and then loses speed, the needle is set correctly. If the engine loses RPM quickly, it is set too lean and the low-speed needle needs to be opened (**counterclockwise**) to richen the mixture. Pinch again to check the mixture. If the engine takes longer than 4 seconds to slow down, lean (**clockwise**) the low-speed needle and then pinch again to check the mixture.

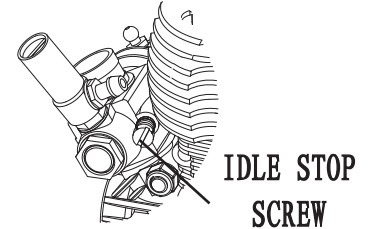

IDLE STOP SCREW

The "idle stop" screw is located on the backside of the carburetor. This increases or decreases the idle speed without changing the fuel mixture. The barrel should be approximately 1mm from fully closed.

IMPORTANT! To insure long life and good performance from your engine, you MUST break-in the engine. The break-in period is critical for long life of the internal parts of the engine. This should be done over the first 5 tanks of fuel.

RUNNING THE ENGINE

STARTING THE ENGINE

IMPORTANT! Your radio system must ALWAYS be turned on and the transmitter antenna fully extended when running the engine!

1. Fill the fuel tank.
2. Prime the engine-while the engine is cool, place your finger over the tuned pipe's exhaust hole and pull the recoil gently several times. Do not over-prime! Stop when you see fuel in the fuel line at the carb.
3. Install a "C" alkaline into the glow starter and attach the starter to the glow plug.
4. With the throttle at idle, start the engine by pulling the recoil using short, quick pulls. Do NOT pull the recoil starter's string to the end. You only need 10 to 12 inches of pull to start the engine with the throttle at idle.

Sometimes it is helpful to start the engine at around half throttle. When the engine starts, immediately return the throttle to idle. If this is not done the engine can over-
rev and cause engine damage.

STOPPING THE ENGINE

Pinch the fuel line that runs to the carburetor. Pinching this line will restrict fuel flow and the engine will quit within a few seconds. Never place your finger over the exhaust to stop the engine. This could result in serious burns on your finger. It also causes fuel to back up in the engine, making it harder to start the next time you run your truck.

IMPORTANT! FIXING A FLOODED ENGINE

If the engine is difficult to turn over with the recoil starter, especially if it is brand new, loosen the glow plug a half turn before starting the engine. This allows some compression to escape, but the engine will still start. Make sure you tighten the glow plug after the engine starts. If the recoil starter is still difficult to pull, the engine is flooded—there is too much fuel inside the engine. Remove the glow plug, then turn the the buggy upside down and pull the recoil 5 or 6 times. This will clear the engine of fuel, and you will notice the recoil pulls easier. Replace the glow plug and repeat the starting procedure.

BREAK IN PROCEDURE

SOME THINGS TO REMEMBER DURING BREAK-IN

1. Run with the body off. This will keep the engine cooler.
2. Keep the air cleaner on at ALL time.
3. Run on a smooth, hard surface. An empty parking lot is Perfect.
4. Use the same fuel that you will use for normal running.
5. Resist the urge to accelerate and decelerate quickly.
6. Break-in puts stress on the glow plug or two on hand.
7. DO NOT overheat the engine. You can check the head temperature by using one of the temperature gauges .

TANK 1

Your first tank of fuel should be running the truck at a very rich needle valve setting. This allows the fuel to carry as much oil as possible into the engine to properly lubricate the internal parts during the break-in.

1. Open the high speed needle valve 4-1/2 turns from fully closed (counterclockwise). This is factory set already. But check it to make sure. When closing the high-speed needle, close until you feel some resistance. DO NOT overtighten or you will damage the engine.
2. Fill the fuel tank and start the engine.
3. Run the buggy on a smooth surface with the body off.
4. Run back and forth at medium speeds, slowly accelerating and decelerating the car.
5. Run the car until the tank is almost out of fuel. Do not allow the tank to run out of fuel during break-in. This leans out the engine and can cause overheating.
6. Stop the engine and allow it to cool. This normally takes around 10-15 minutes.

NOTE: if your engine does not stay running consistently, increase the idle speed by turning the idle stop screw clockwise.

TANK 2

Lean the high-speed needle 1/2 turn from "tank 1" setting. Run the car for the complete tank and then let cool.

TANK 3

Lean the high-speed needle another 1/2 turn from "tank 2" setting. Run the car for the complete tank and then let cool.

TANK 4

Lean the high-speed needle another 1/2 turn from "tank 3" setting. Run the car for the complete tank and then let cool. You should notice the engine running much better at this point.

TANK 5

Lean the high-speed needle another 1/2 turn from "tank 4" setting. Run the car for the complete tank and then let cool. The engine is now ready to be performance tuned.

Important! At this point, the engine will likely be running at a faster idle than needed (This is typical after break-in). Adjust the idle stop screw to lower the idle speed so that the wheels do not, or just barely, rotate when you lift the car off the ground.

TUNING TIPS

After break-in, run the truck where you plan to do most of your driving (grass, street, track, etc). Tune the high speed needle so the engine makes good power without overheating. Using a temperature gauge, tune the engine so that it will consistently stay under 270 F (132 C). Keep in mind. RC engines usually take a minute or two to warm up. It is common not to reach full power right away. Never tune a cold engine!

ENGINE CARE

Never store your car with fuel in the tank. We recommend that after the final run of the day, you empty the fuel tank and then run the engine at idle until all the fuel is out of the fuel lines and engine. Remove air filter and glow plug. Then place two drops of the After Run Engine Oil in the carburetor and two into the cylinder to help prevent corrosion. Pull the re-coil a few times to circulate the oil.

10 WAYS TO ENSURE LONG LIFE FROM YOUR ENGINE

1. Keep your engine and air filter clean. Dirt will act as insulation on an engine. It will not be able to shed heat as easily. Clean and re-oil the element often.
2. Do not over-lean your engine.
3. Do not run your engine with little or no load. Don't throttle up the engine to full throttle when the wheels are not in contact with the ground.
4. Do not overheat the engine.
5. Do not use a fuel with a low oil content. Make sure you use a model car fuel from a reputable manufacturer, such as O'Donnell Fuels.
6. Avoid using old fuels in the engine.
7. Do not use a fuel with a nitromethane (often called niteo) content over 20%.
8. Do not scratch the piston or cylinder sleeve. Avoid jamming something into the exhaust port when removing or re-installing the clutch or flywheel. Use a special tool called the Ultimate Flywheel Wrench to keep the crankshaft from moving.
9. Do not use silicone sealer on the engine joints. Silicone sealer contains acetic acid, which is corrosive if it gets inside your engine.
10. Do not allow any water to get inside the engine. This sounds easy, but temperature changes can cause condensation inside the engine. This is a good reason to use an after-run oil. Store your engine inside the house, not in a garage or shed where there will be temperature extremes.

EXPLODED VIEW

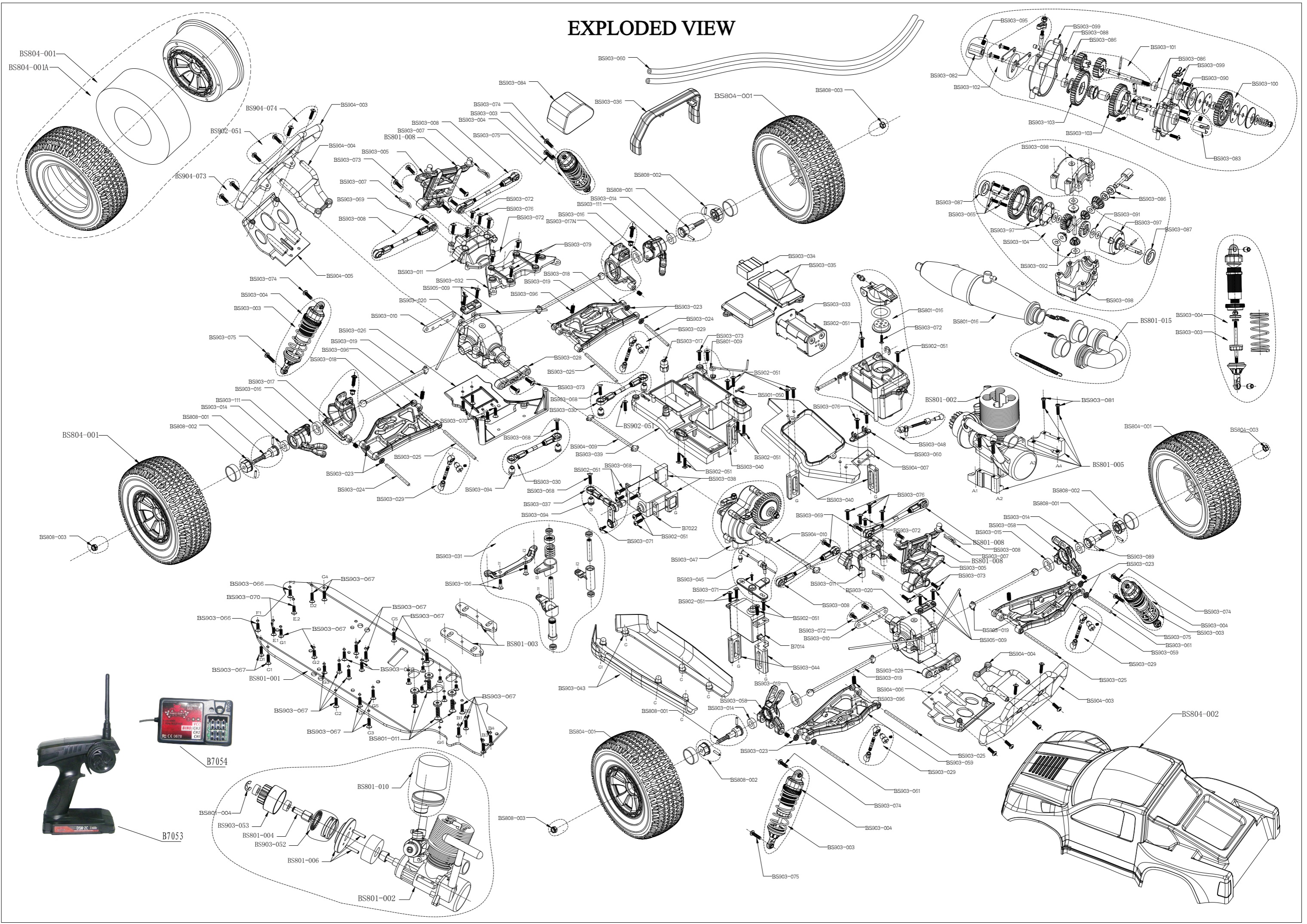

PARTS LIST

Item No.	Description	Item No.	Description
BS804-001	Tire unit 2pcs	BS903-036	Rear aluminum shocks 2pcs
BS804-001A	Tire unit(chromed) 2pcs	BS903-037	Steering servo horn and linkage
BS804-002	Silk-screened body 1pcs	BS903-038	Steering servo mount-A/B
BS904-003	Bumper 2pcs	BS903-039	Upper deck-centre 1pcs
BS904-004	Bumper brace 2pcs	BS903-040	Upper deck mount 1pcs
BS904-005	Bumper chassis-Fr 1pcs	BS903-043	Side guard plate-L/R
BS904-006	Bumper chassis-Rr 1pcs	BS903-044	Throttle servo mount-A/B
BS904-007	Upper plate-Rr 1pcs	BS903-045	Throttle servo horn and linkage set
BS904-009	Dogbone-Fr 1pcs	BS903-047	Gearbox unit
BS904-010	Dogbone-Rr 1pcs	BS903-048	Throttle linkage set
BS904-013	Silk-screened body 1pcs	BS903-052	Clutch shoe w/spring
BS903-004	Shock absorber unit(alum.) 2pcs	BS903-053	Clutch bell(18T)
BS903-005	Brace 1pcs	BS903-058	Rear hub
BS903-007	Body pin 6pcs	BS903-059	Rr.lower susp.arm-L /R
BS903-008	Upper susp. Arm set	BS903-060	Fuel pipe & hoop
BS903-010	Supension arm mount block 2pcs	BS903-061	Rear suspension arm pin-short
BS903-011	Upper susp.arm mount-Fr/Rr	BS903-065	TPF2.6*10 flat cross screw 12pcs
BS808-002	Rim hub w/pin 2*10 4pcs	BS903-066	TPF3*8 flat cross screw 12pcs
BS808-001	Axle w/pin 2pcs	BS903-067	TPF3*10 flat cross screw 12pcs
BS903-014	Ball bearing(6*12*4) 2pcs	BS903-068	TPF3*14 flat cross screw 12pcs
BS903-016	Ball bearing(10*15*4) 2pcs	BS903-069	TPF3*16 flat cross screw 12pcs
BS903-017N	C-carrier/w/screw	BS903-070	ISO3*10 flat cross screw 12pcs
BS903-018	Fr.lower susp.arm-Lf/Rt	BS903-071	BT2.6*6 B-head cross screw 12pcs
BS903-019	Transverse driver shaft set	BS903-072	BT3*8 B-head cross screw 12pcs
BS903-020	Diff.gearbox unit	BS903-073	BT3*12 B-head cross screw 12pcs
BS903-023	O-washer 4pcs	BS903-074	BT3*14 B-head cross screw 12pcs
BS903-024	Front suspension arm pin-short 4pcs	BS903-075	BT3*16 B-head cross screw 12pcs
BS903-025	Suspension arm pin-long 4pcs	BS903-076	BT3*20 B-head cross screw 12pcs
BS903-026	Fr.chassis	BS903-079	BM3*10 B-head cross screw 12pcs
BS903-028	Lower susp.mount block-Fr/Rr	BS903-081	HM3*10 Cap head hexagon screw 6pcs
BS903-029	Anti-roll bar fixation set	BS903-082	Diff.outdrive C /M4*4set screw
BS903-030	Steering linkage set 2pcs	BS903-083	Diff.Outdrover D/M4*4 set screw
BS903-031	Servo saver unit	BS903-084	Battery pack 6V NI-MH 1pcs
BS903-032	Upper deck-Fr	BS903-086	Ball bearing (5*10*4) 2pcs
BS903-033	Battery case 1pcs	BS903-087	Ball bearing (12*18*4) 2pcs
BS903-034	Switch/switch cover/screw	BS903-088	E -clip (4*0.6) 12pcs
BS903-035	Receiver/battery case cover	BS903-089	Pin (2*9.5) 12pcs
BS808-003	M5 self-lock nut 4pcs		

PARTS LIST

Item No.	Description	
BS903-091	Washer A (5.2*10*0.2)	12pcs
BS903-092	Washer B (4.2*8*0.2)	12pcs
BS808-003	M5 nylon lock nut	6pcs
BS903-094	Double way ball end	6pcs
BS903-095	M4*4 grub screw	6pcs
BS903-096	M4*8 grub screw	6pcs
BS903-097	Diff.gearbox	
BS903-098	Diff.gearbox bulkhead-upper/lower	
BS903-099	Gearbox bulkhead-Fr/Rr	
BS903-100	Spur gear /spring/nylon-lock nut	
BS903-101	Pinion gear 18T/19T /pin	
BS903-102	Brake set	
BS903-103	Gear-40T/37T	
BS903-104	Diff.unit	
BS903-105	Driving/driven gear,Diff.gear/bevel gears	
BS903-106	Screw pin (M3*9.5)	12pcs
BS903-107	Screw (M2.5*13)	12pcs
BS903-108	Charger	1pcs
BS903-109	Diff.outdrive A/Pin(2*10)	
BS903-110	Diff.outdrive B/Pin(2*10)	
BS903-111	Kunckle Arm-L/R(metal)	
BS901-067	Antenna pipe w/cap	3PCS
BS902-051	BT3*10 B-head cross screw	12pcs

Item No.	Description
BS801-001	Chassis
BS801-002	21#engine
BS801-003	Engine washer/screw
BS801-004	Engine crankshaft w/E-clip
BS801-005	Engine mount-L/F
BS801-006	Engine flywheel w/pin
BS801-007	Metal pipe
BS801-008	Fr/Rr body post
BS801-009	Alum exhaust fixation set
BS801-011	IS04*10 flat cross screw/washer
BS801-015	Exhaust manifold
BS801-016	Fuel tank unit
BS801-019	Air filter w/insert
BS905-009	Rear anti-roll bar set
B7053	Transmitter complete
B7054	Receiver
B7014	Servo (3Kg)
B7018	Servo (6Kg)
MP0-02	C hub/C hub pin
MP0-04	Rear hub set
MP0-05	Shock stay mount
MP0-06	Front suspension mount
MP0-07	Rear suspension mount
MP0-08	Steel brake disk
MP0-09	Special brake pads
MP0-10	Brake post
MP0-11	Steering link
MP0-12	Engine mount
MP0-13	Sipper system(hard anodized)

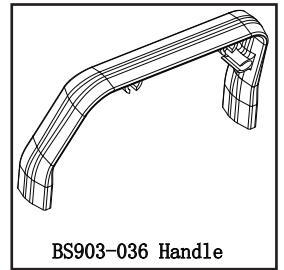
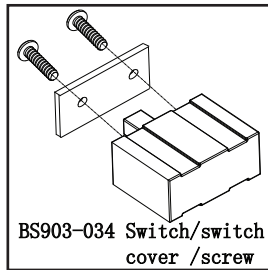
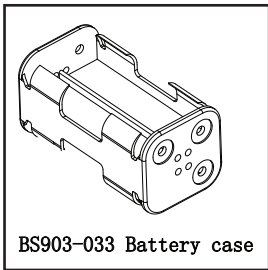
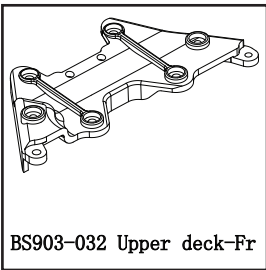
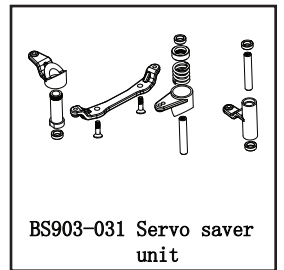
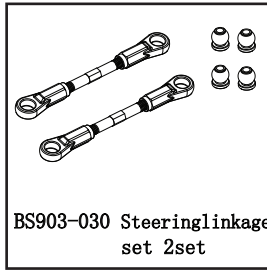
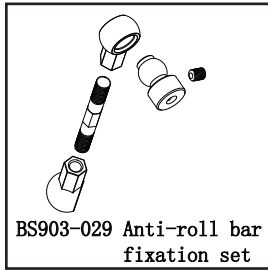
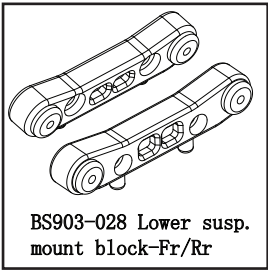
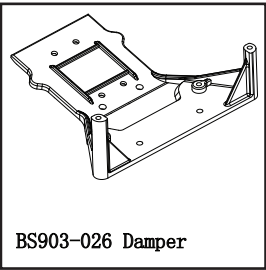
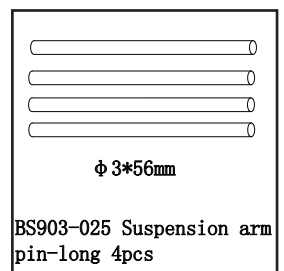
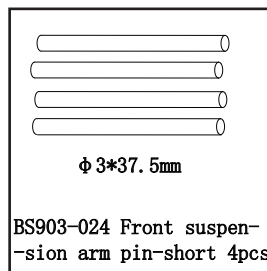
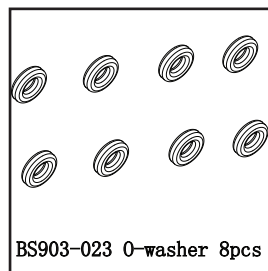
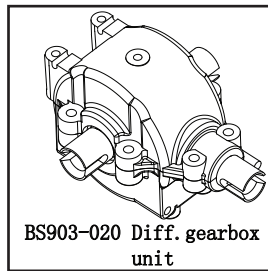
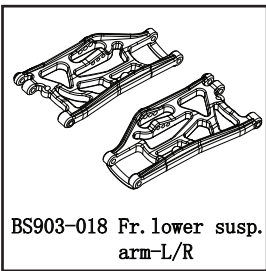
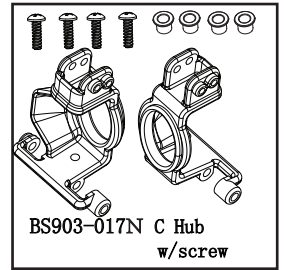
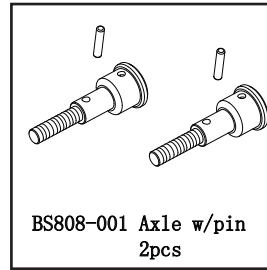
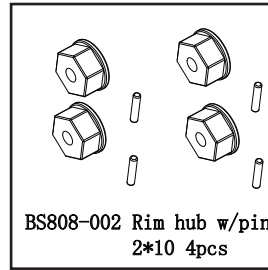
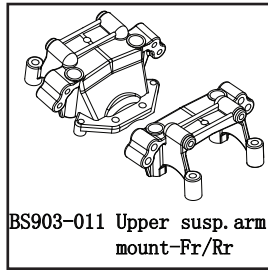
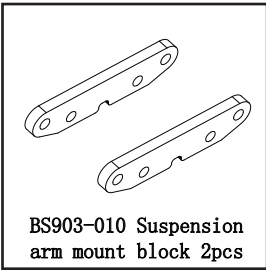
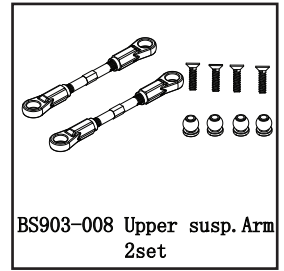
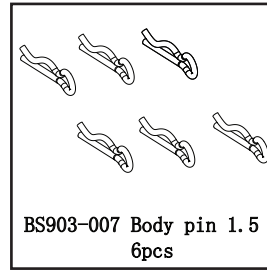
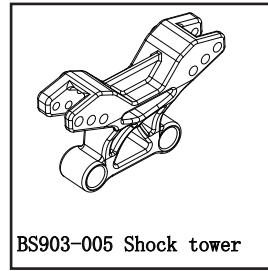
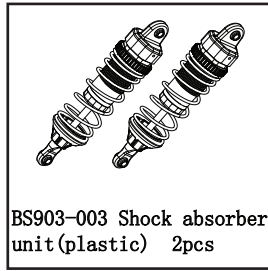
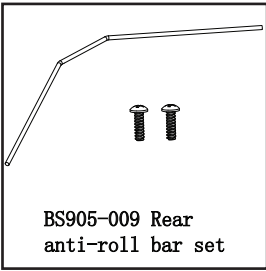
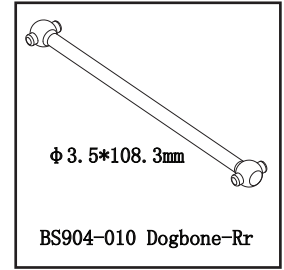
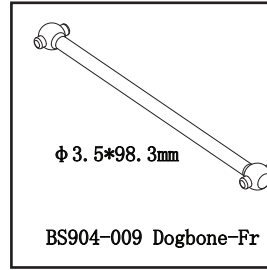
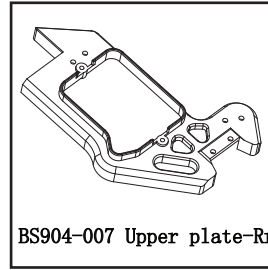
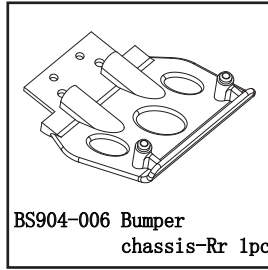
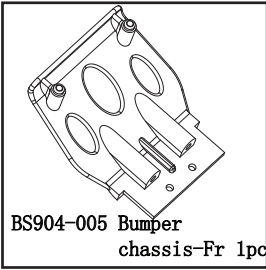
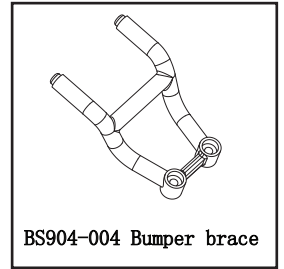
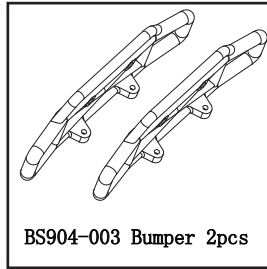
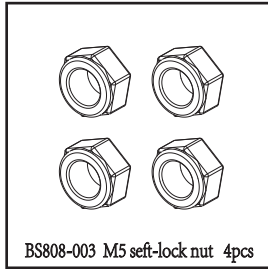
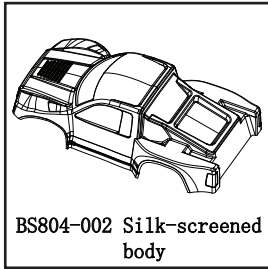

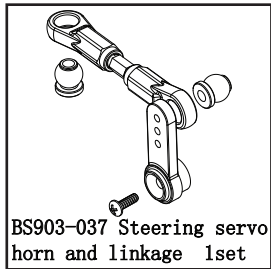

BS903-037 Steering servo horn and linkage 1set

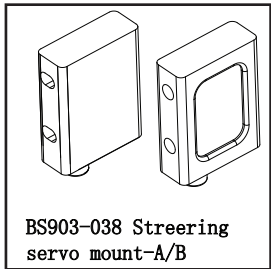

BS903-038 Steering servo mount-A/B

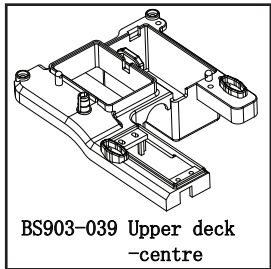

BS903-039 Upper deck -centre

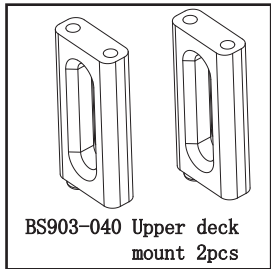

BS903-040 Upper deck mount 2pcs

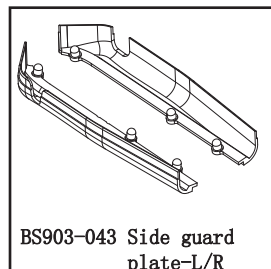

BS903-043 Side guard plate-L/R

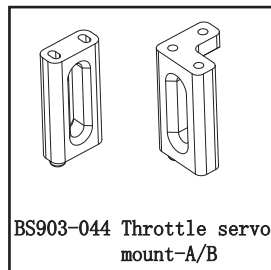

BS903-044 Throttle servo mount-A/B

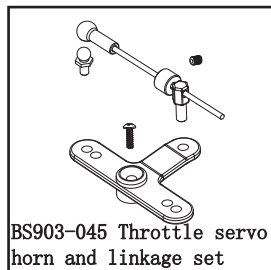

BS903-045 Throttle servo horn and linkage set

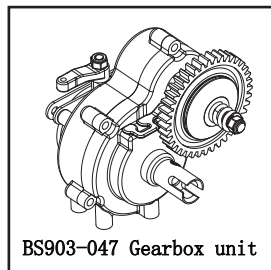

BS903-047 Gearbox unit

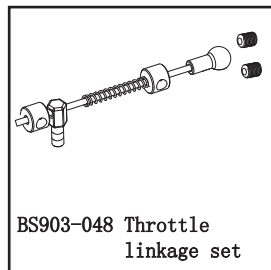

BS903-048 Throttle linkage set

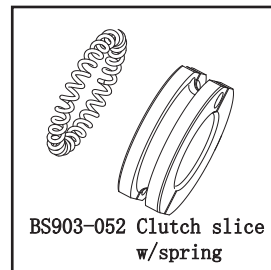

BS903-052 Clutch slice w/spring

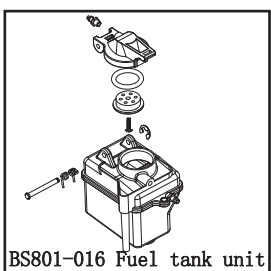

BS801-016 Fuel tank unit

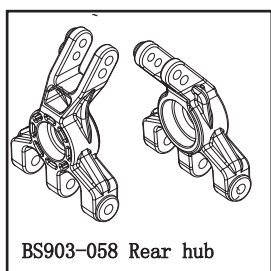

BS903-058 Rear hub

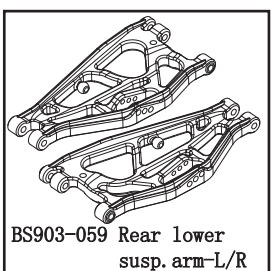

BS903-059 Rear lower susp. arm-L/R

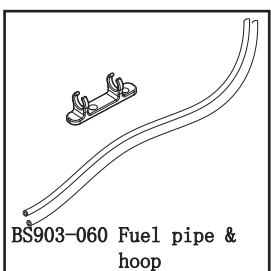

BS903-060 Fuel pipe & hoop

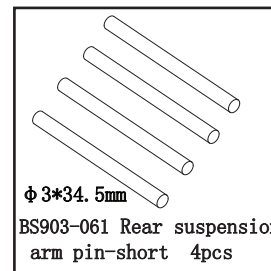

BS903-061 Rear suspension arm pin-short 4pcs

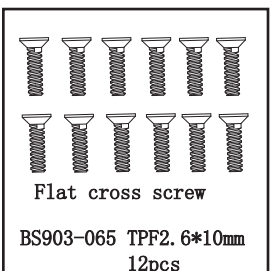

Flat cross screw
BS903-065 TPF2. 6*10mm
12pcs

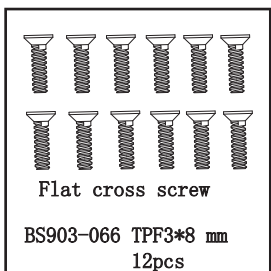

Flat cross screw
BS903-066 TPF3*8 mm
12pcs

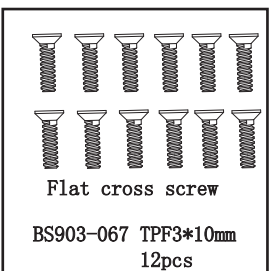

Flat cross screw
BS903-067 TPF3*10mm
12pcs

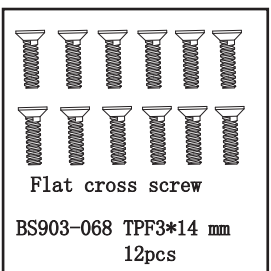

Flat cross screw
BS903-068 TPF3*14 mm
12pcs

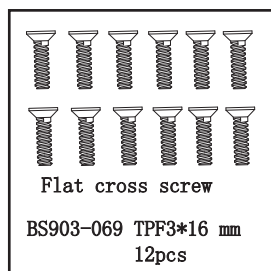

Flat cross screw
BS903-069 TPF3*16 mm
12pcs

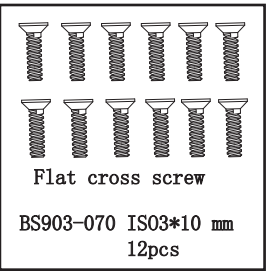

Flat cross screw
BS903-070 IS03*10 mm
12pcs

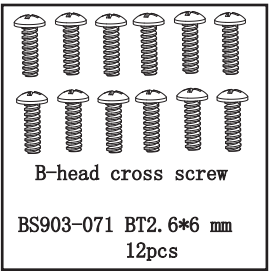

B-head cross screw
BS903-071 BT2. 6*6 mm
12pcs

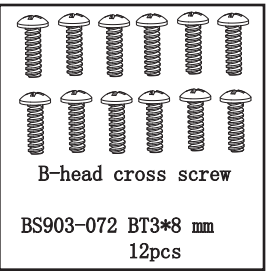

B-head cross screw
BS903-072 BT3*8 mm
12pcs

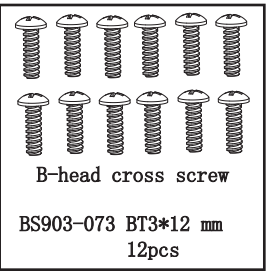

B-head cross screw
BS903-073 BT3*12 mm
12pcs

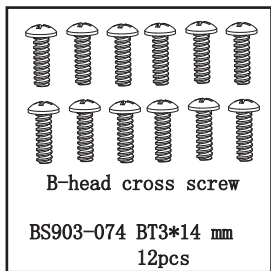

B-head cross screw
BS903-074 BT3*14 mm
12pcs

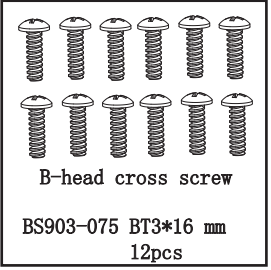

B-head cross screw
BS903-075 BT3*16 mm
12pcs

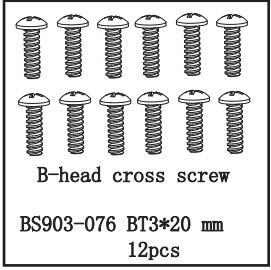

B-head cross screw
BS903-076 BT3*20 mm
12pcs

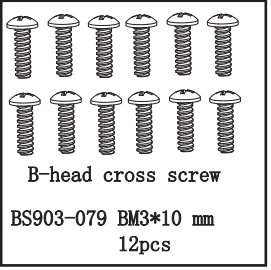

B-head cross screw
BS903-079 BM3*10 mm
12pcs

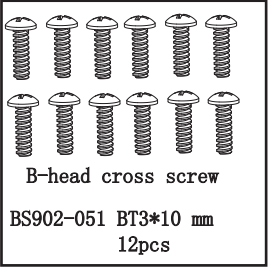

B-head cross screw
BS902-051 BT3*10 mm
12pcs



Socket head cap screw
BS903-081 M3*10 mm 6pcs

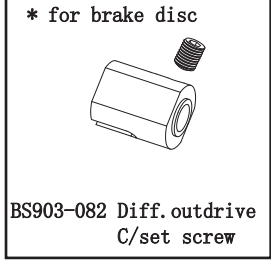

* for brake disc
BS903-082 Diff. outdrive C/set screw

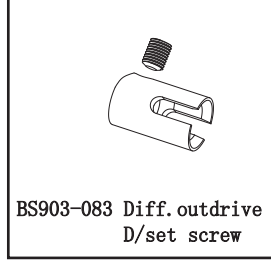

BS903-083 Diff. outdrive D/set screw

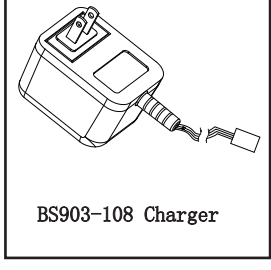

BS903-108 Charger

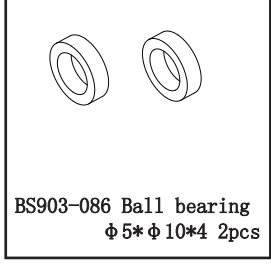

BS903-086 Ball bearing
phi 5* phi 10*4 2pcs

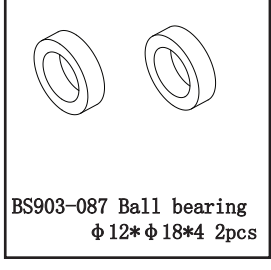

BS903-087 Ball bearing
phi 12* phi 18*4 2pcs

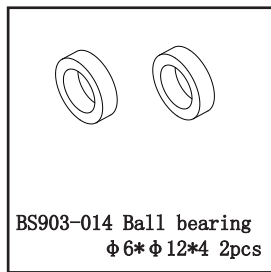

BS903-014 Ball bearing
φ6*φ12*4 2pcs

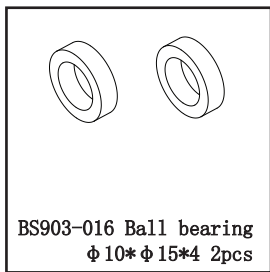

BS903-016 Ball bearing
φ10*φ15*4 2pcs

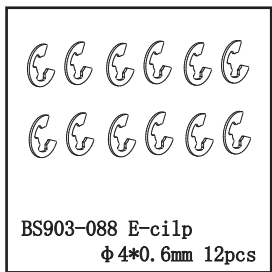

BS903-088 E-clip
φ4*0.6mm 12pcs

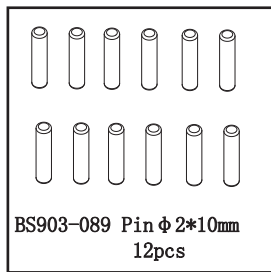

BS903-089 Pin φ2*10mm
12pcs

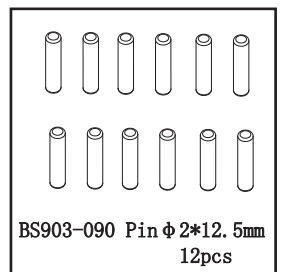

BS903-090 Pin φ2*12.5mm
12pcs

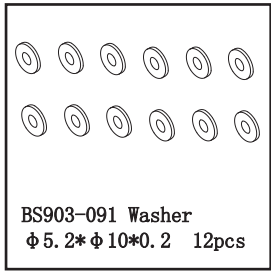

BS903-091 Washer
φ5.2*φ10*0.2 12pcs

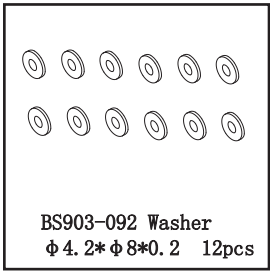

BS903-092 Washer
φ4.2*φ8*0.2 12pcs

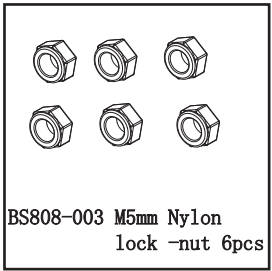

BS808-003 M5mm Nylon
lock -nut 6pcs

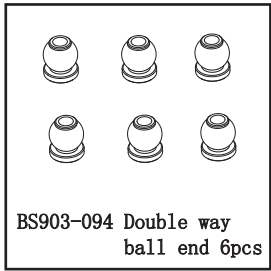

BS903-094 Double way
ball end 6pcs

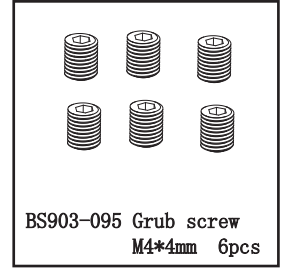

BS903-095 Grub screw
M4*4mm 6pcs

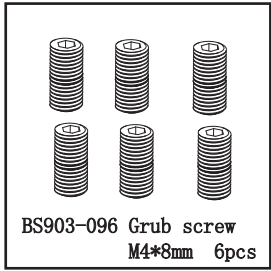

BS903-096 Grub screw
M4*8mm 6pcs

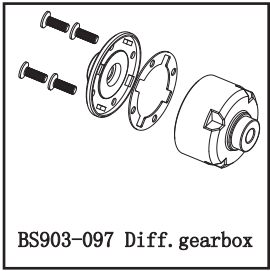

BS903-097 Diff. gearbox

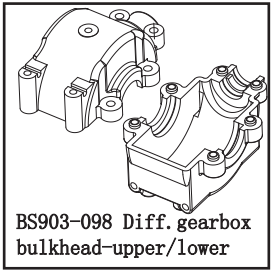

BS903-098 Diff. gearbox
bulkhead-upper/lower

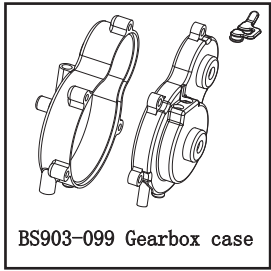

BS903-099 Gearbox case

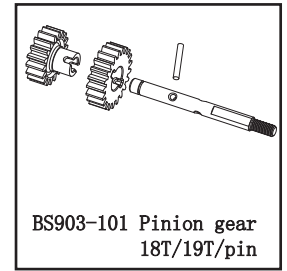

BS903-101 Pinion gear
18T/19T/pin

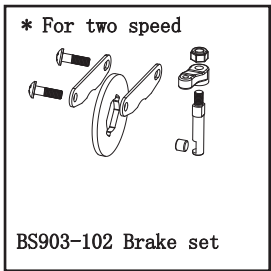

* For two speed

BS903-102 Brake set

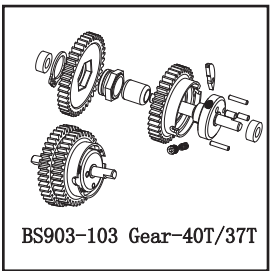

BS903-103 Gear-40T/37T

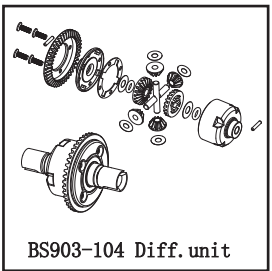

BS903-104 Diff. unit

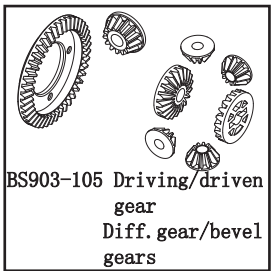

BS903-105 Driving/driven
gear
Diff. gear/bevel
gears

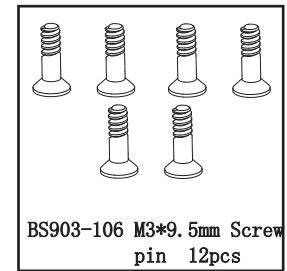

BS903-106 M3*9.5mm Screw
pin 12pcs

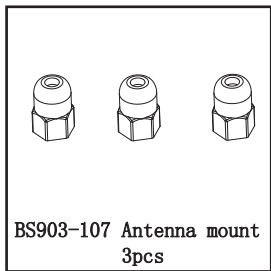

BS903-107 Antenna mount
3pcs

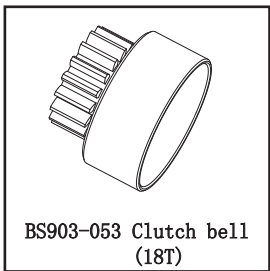

BS903-053 Clutch bell
(18T)

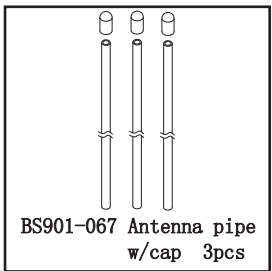

BS901-067 Antenna pipe
w/cap 3pcs



B7053 Transmitter
complete



B7054 Receiver 1pcs

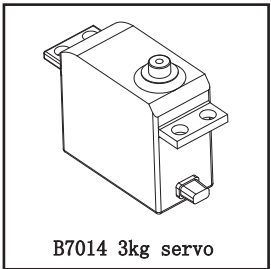

B7014 3kg servo

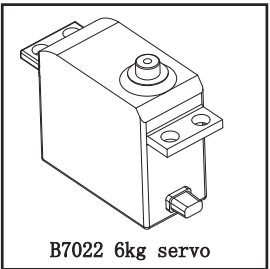

B7022 6kg servo

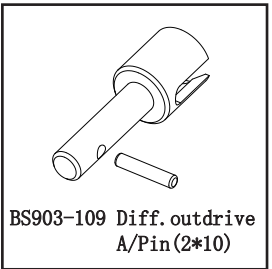

BS903-109 Diff. outdrive
A/Pin(2*10)

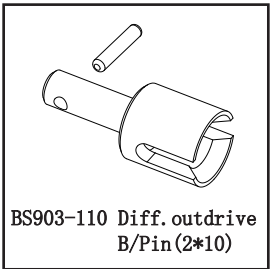

BS903-110 Diff. outdrive
B/Pin(2*10)

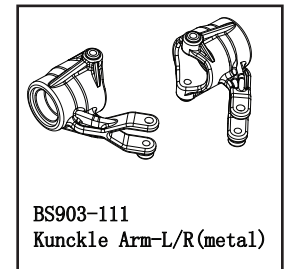

BS903-111
Kunckle Arm-L/R(metal)

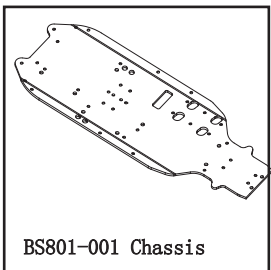

BS801-001 Chassis

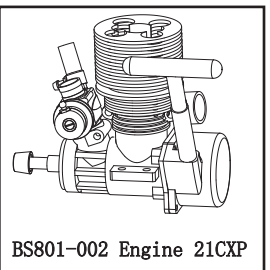

BS801-002 Engine 21CXP

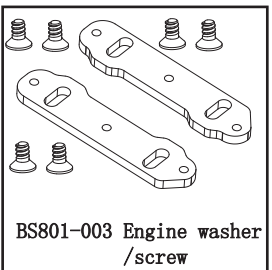

BS801-003 Engine washer
/screw

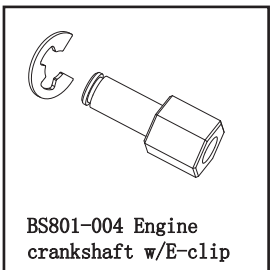

BS801-004 Engine
crankshaft w/E-clip

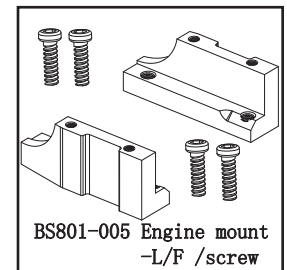

BS801-005 Engine mount
-L/F /screw

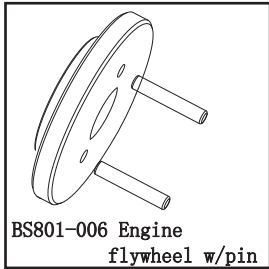

BS801-006 Engine flywheel w/pin

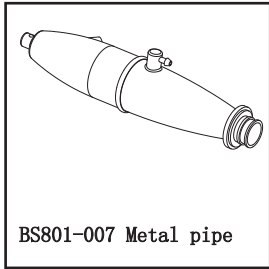

BS801-007 Metal pipe

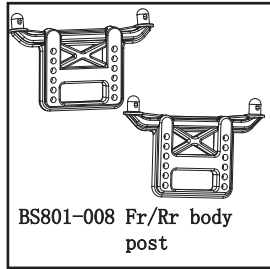

BS801-008 Fr/Rr body post

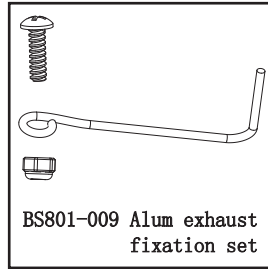

BS801-009 Alum exhaust fixation set

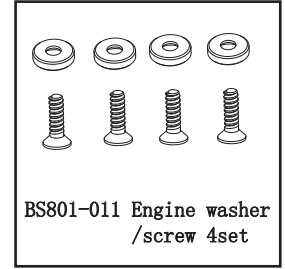

BS801-011 Engine washer /screw 4set

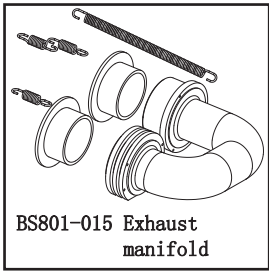

BS801-015 Exhaust manifold



BS801-019 Air filter W/Insert

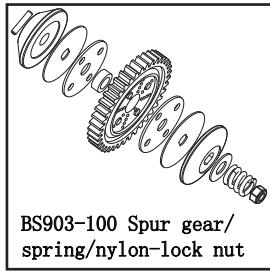

BS903-100 Spur gear/spring/nylon-lock nut



Stainless steel AL6061

MPO-02 C HUB C HUB W/Pin



Stainless steel AL6061

MPO-03 Knuckle Arm Set



Stainless steel AL6061

MPO-05 Shock stay mount



Stainless steel AL6061

MPO-06 Front suspension mount



Stainless steel AL6061

MPO-07 Rear suspension mount

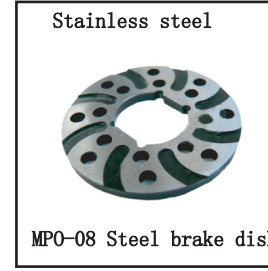

Stainless steel

MPO-08 Steel brake disk



Stainless steel

MPO-09 Special brake pads

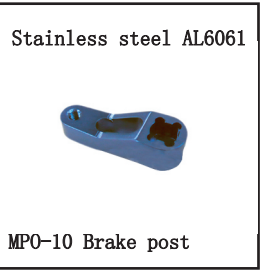

Stainless steel AL6061

MPO-10 Brake post



Stainless steel AL6061

MPO-11 Steering link

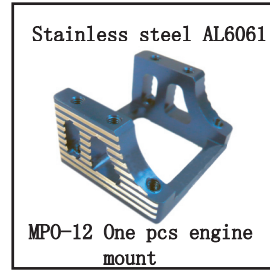

Stainless steel AL6061

MPO-12 One pcs engine mount



Stainless steel AL6061

MPO-13 Sipper system (hard anodized)

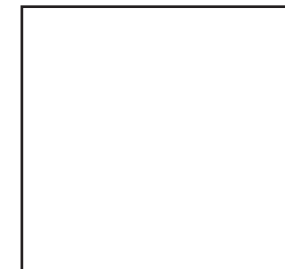
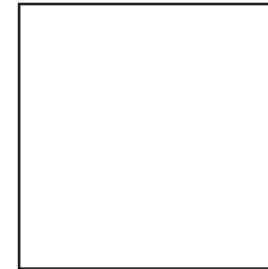
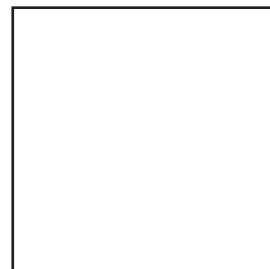
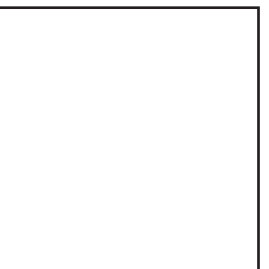
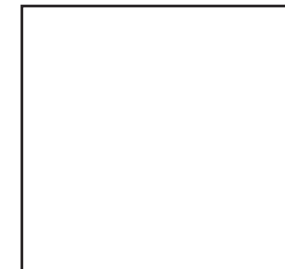
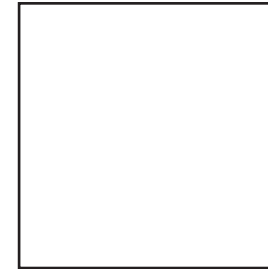
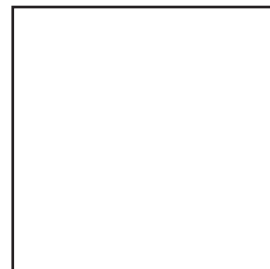
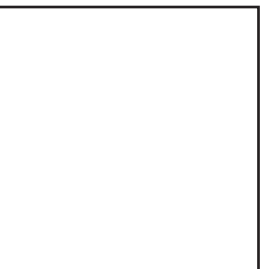
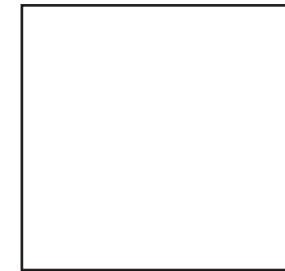
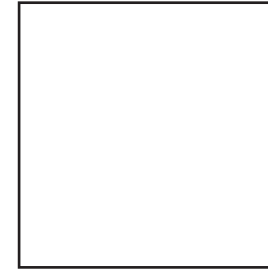
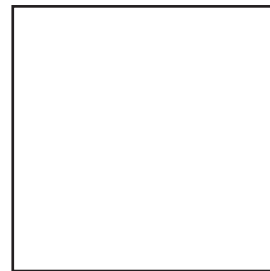
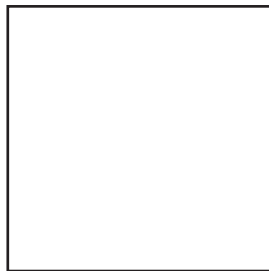
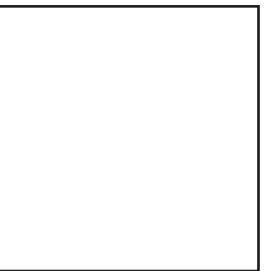
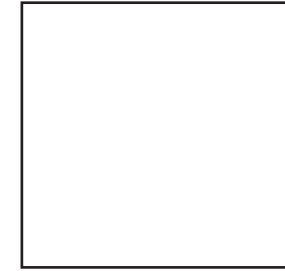

Redcat Racing

<http://www.redcatracing.com>